

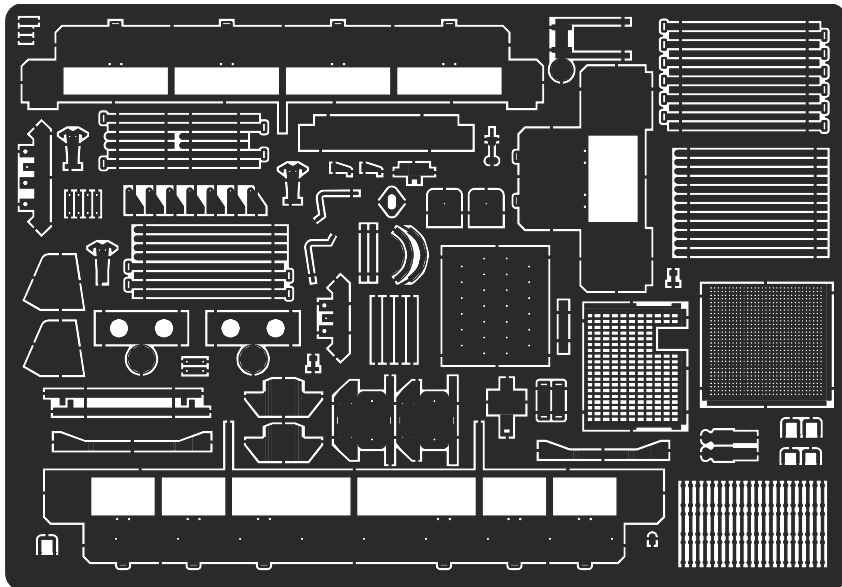

M-113 Samson 1/35 F3060
Conversion set

1/10

Conversion set for kits M-113 ACADEMY, ITALERI or TAMIYA

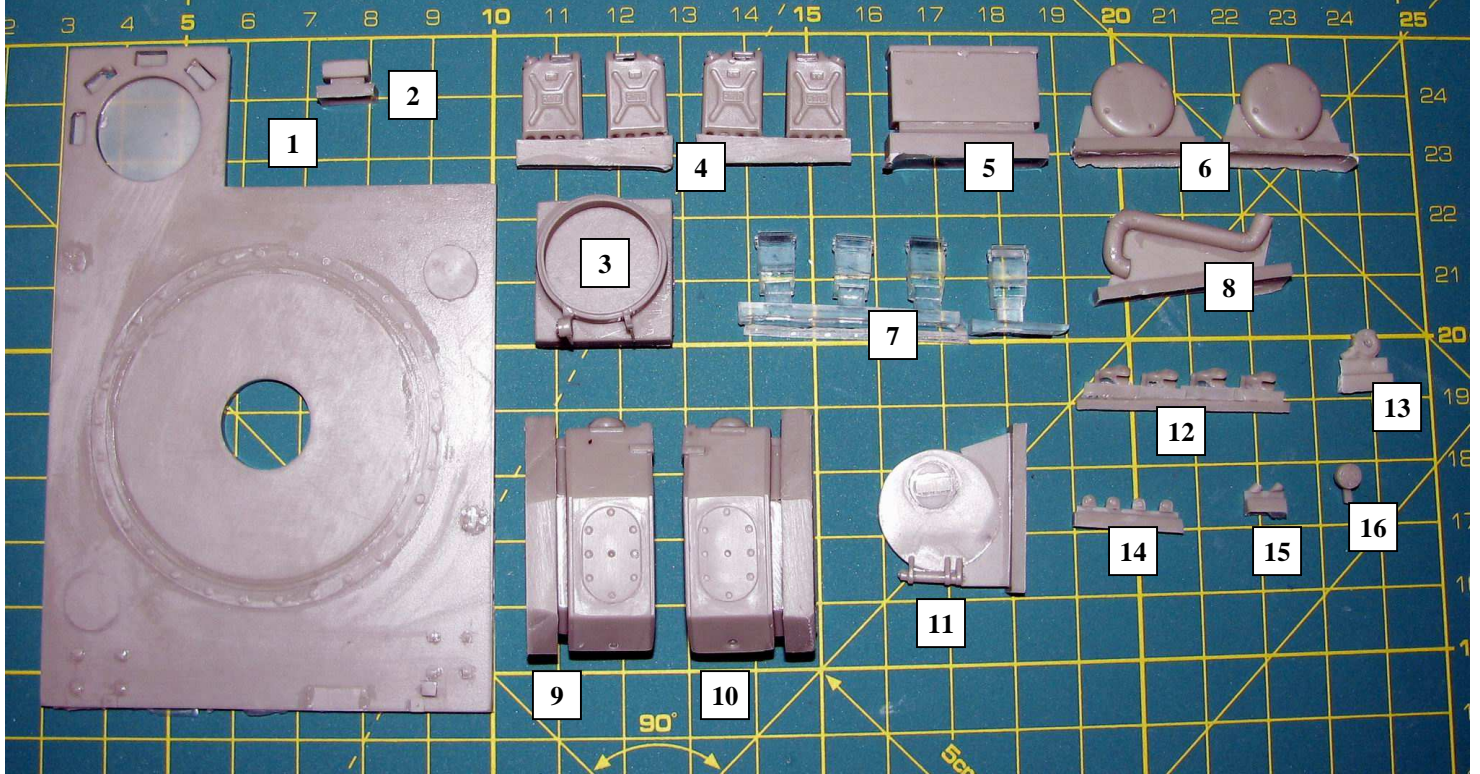

RESIN PARTS



PHOTO-ETCHED PARTS





M-113 Samson 1/35
Conversion set

F3060

2/10

A

B

C

PLASTIC ROD $\varnothing 0,5 - 1,2\text{mm}$

D



M-113 Samson 1/35 F3060
Conversion set

3/10

E

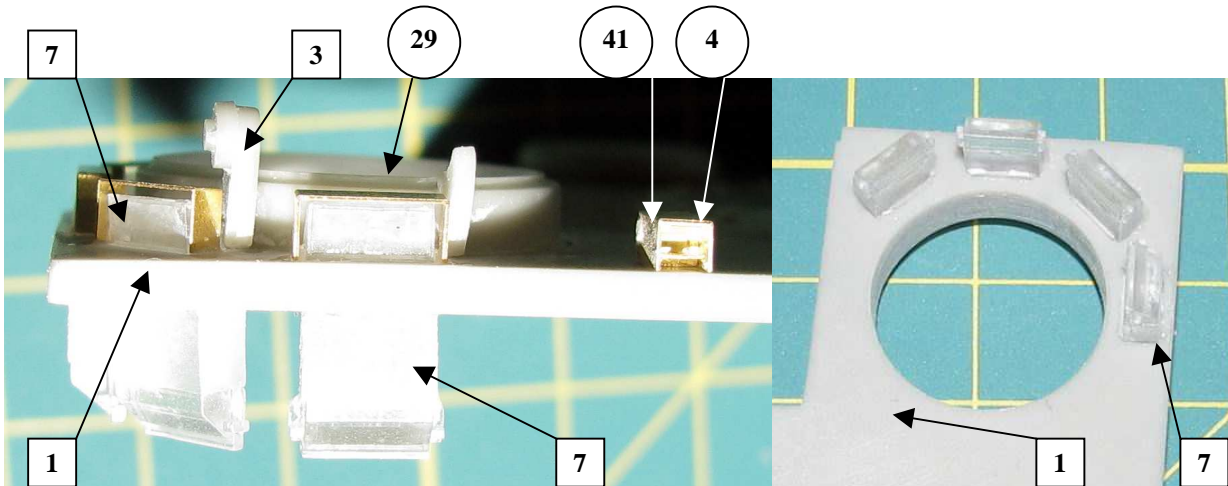
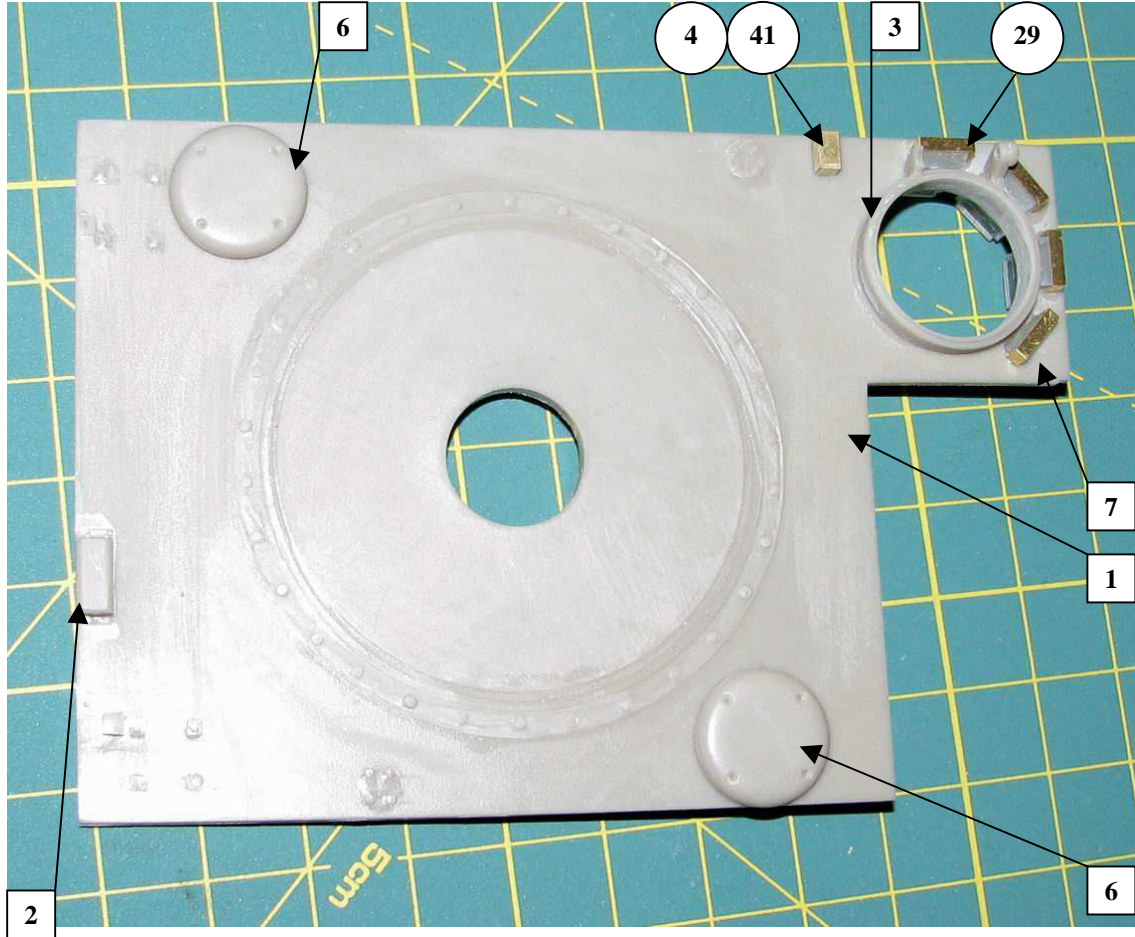

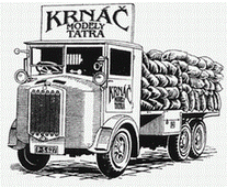

M-113 Samson 1/35 F3060 Conversion set

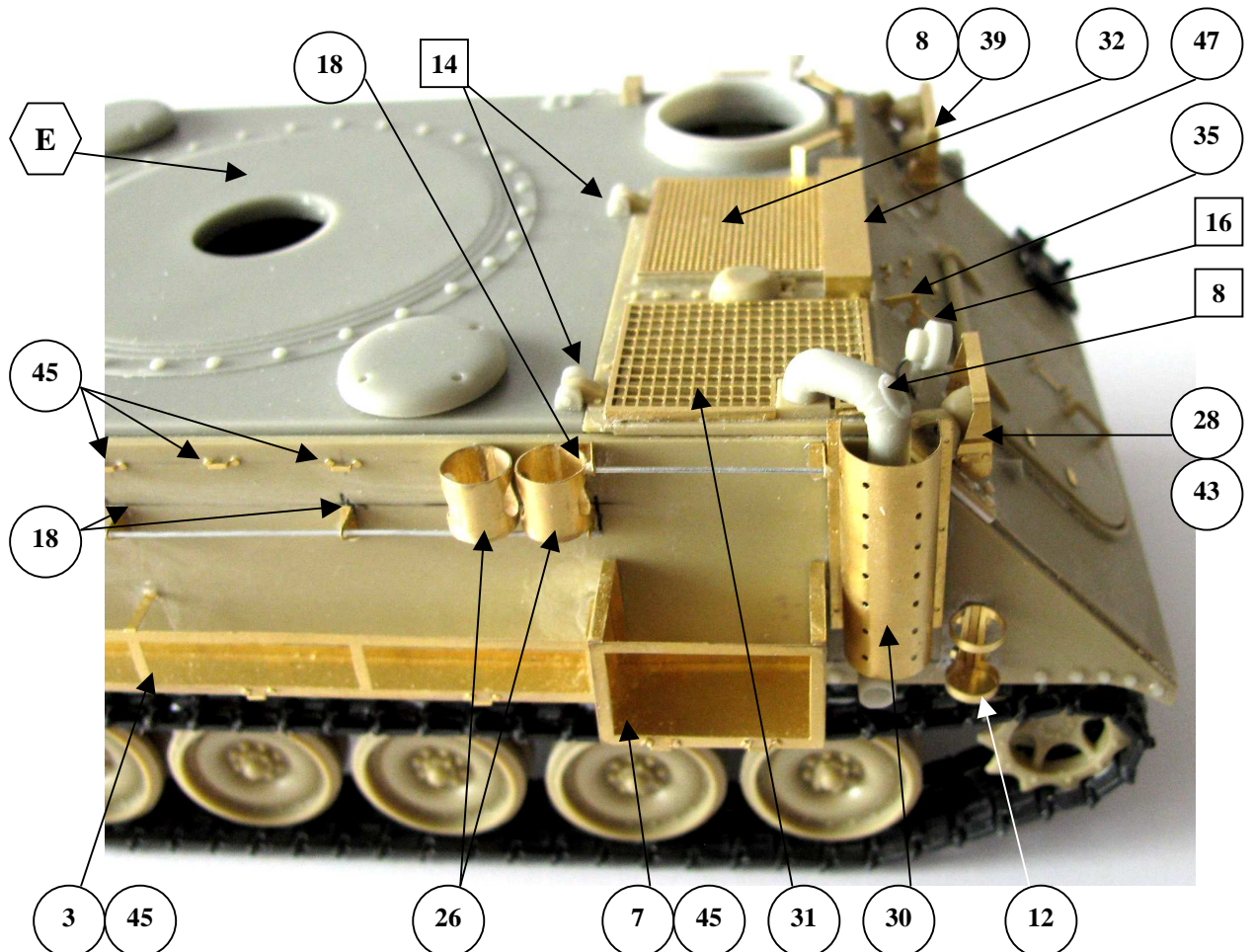
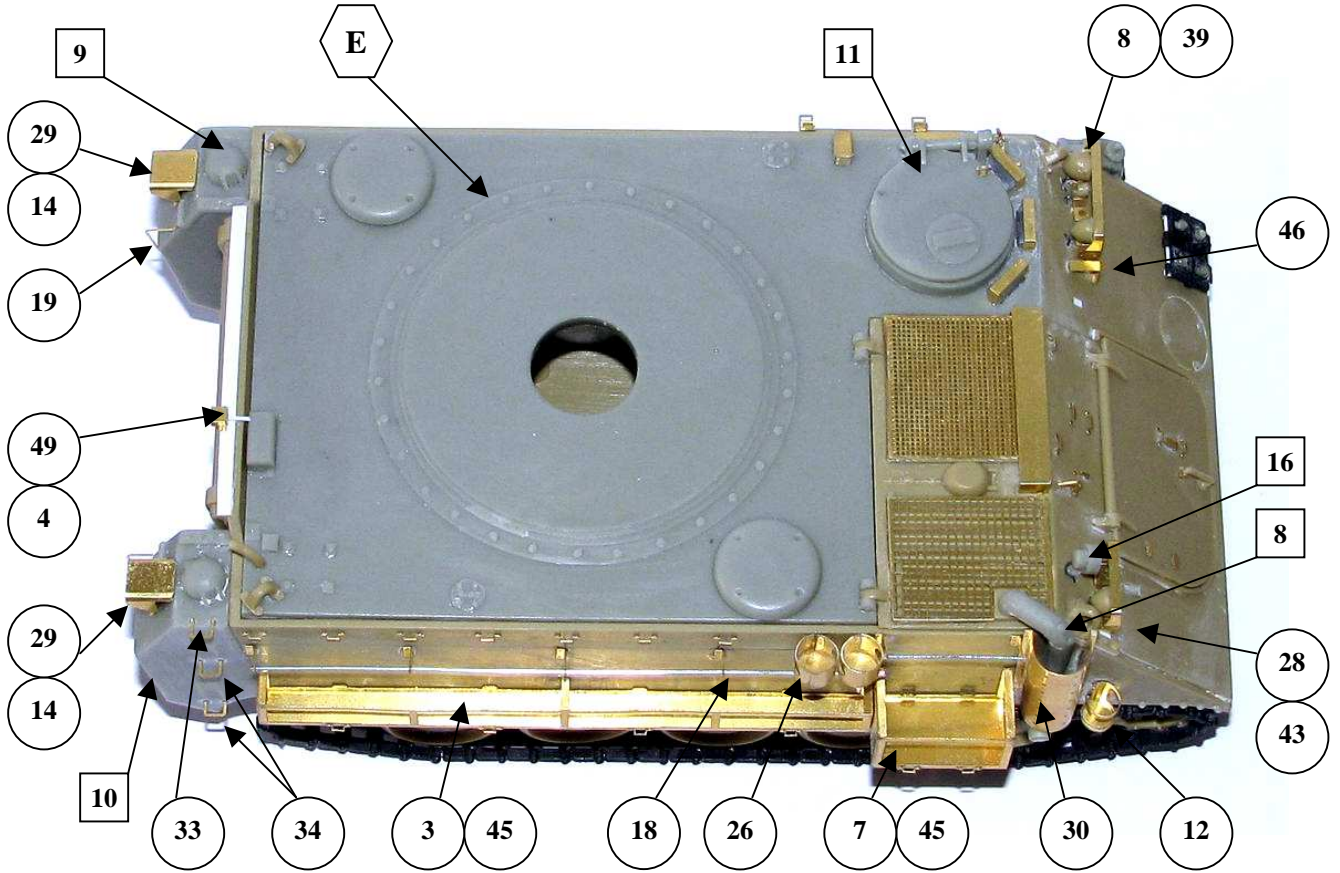

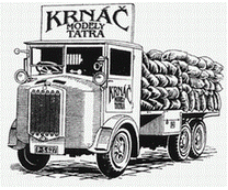

M-113 Samson 1/35 F3060 Conversion set

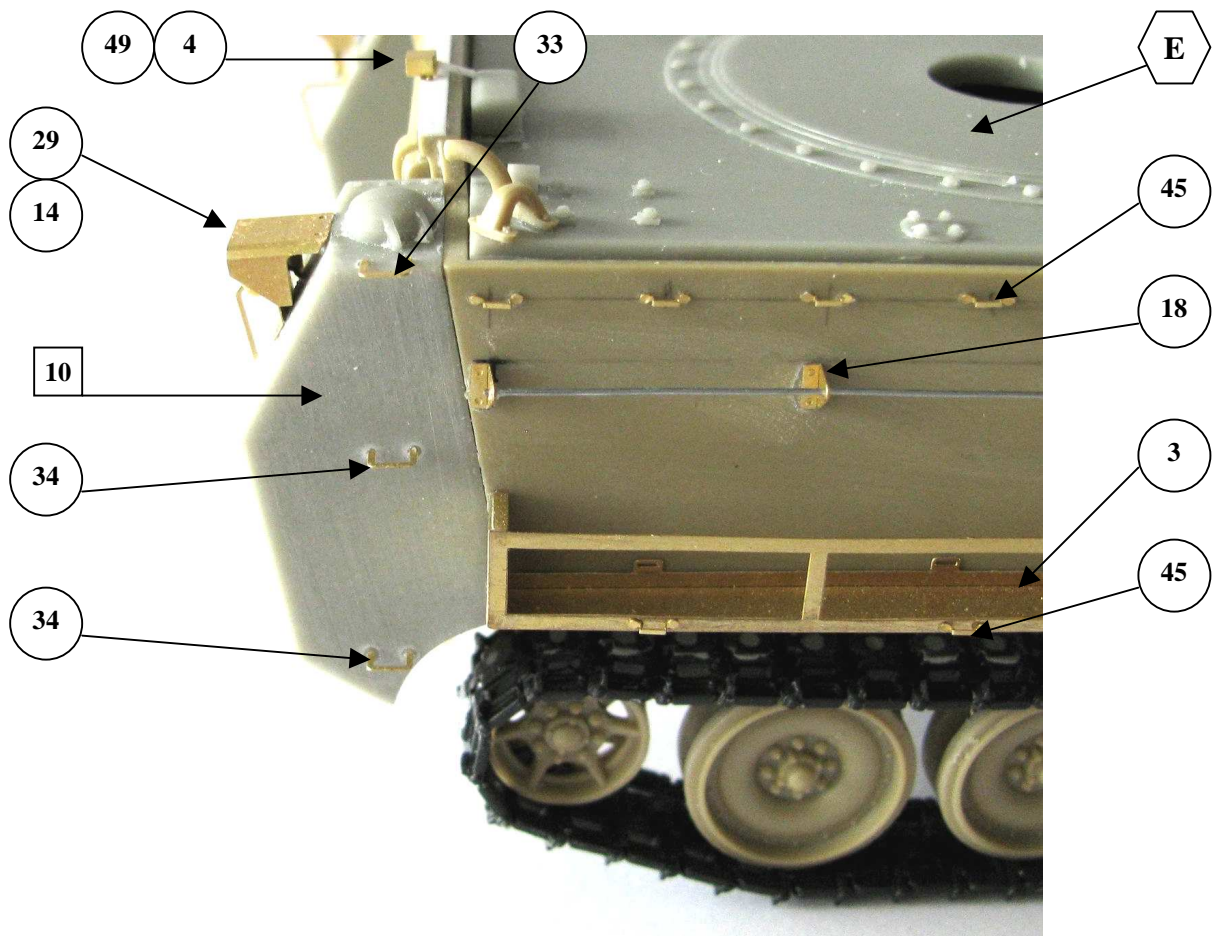
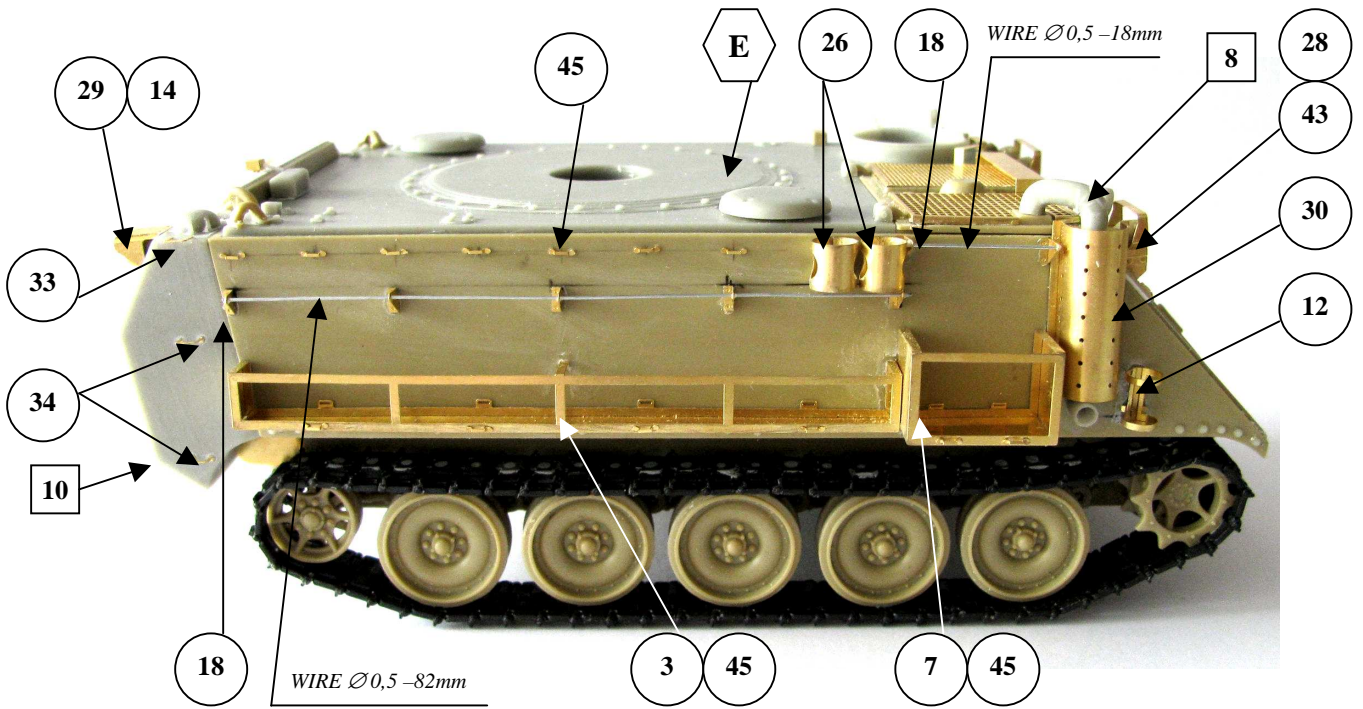

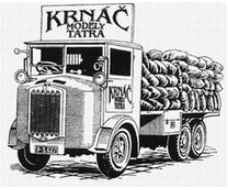

M-113 Samson 1/35 F3060
Conversion set

6/10

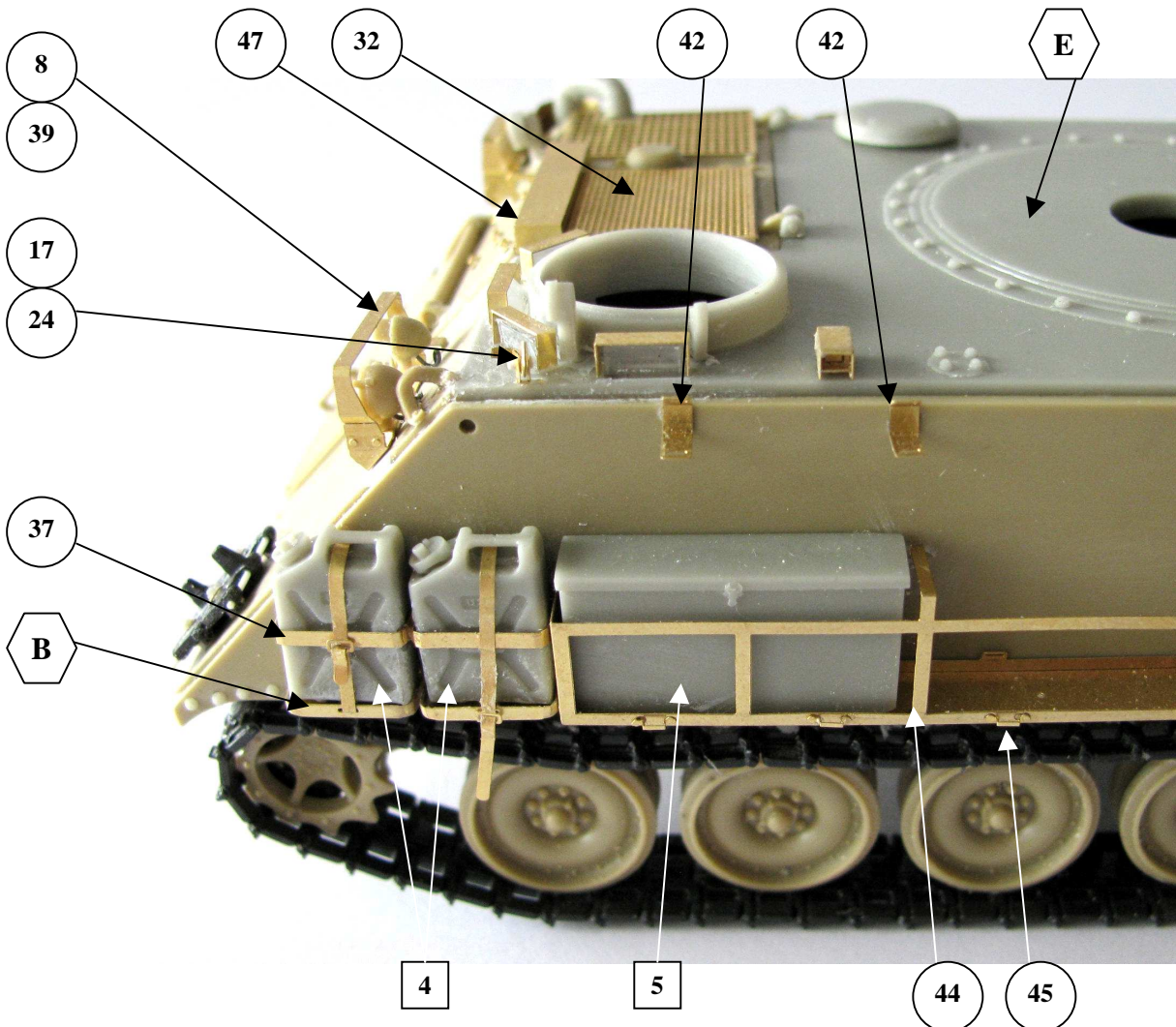
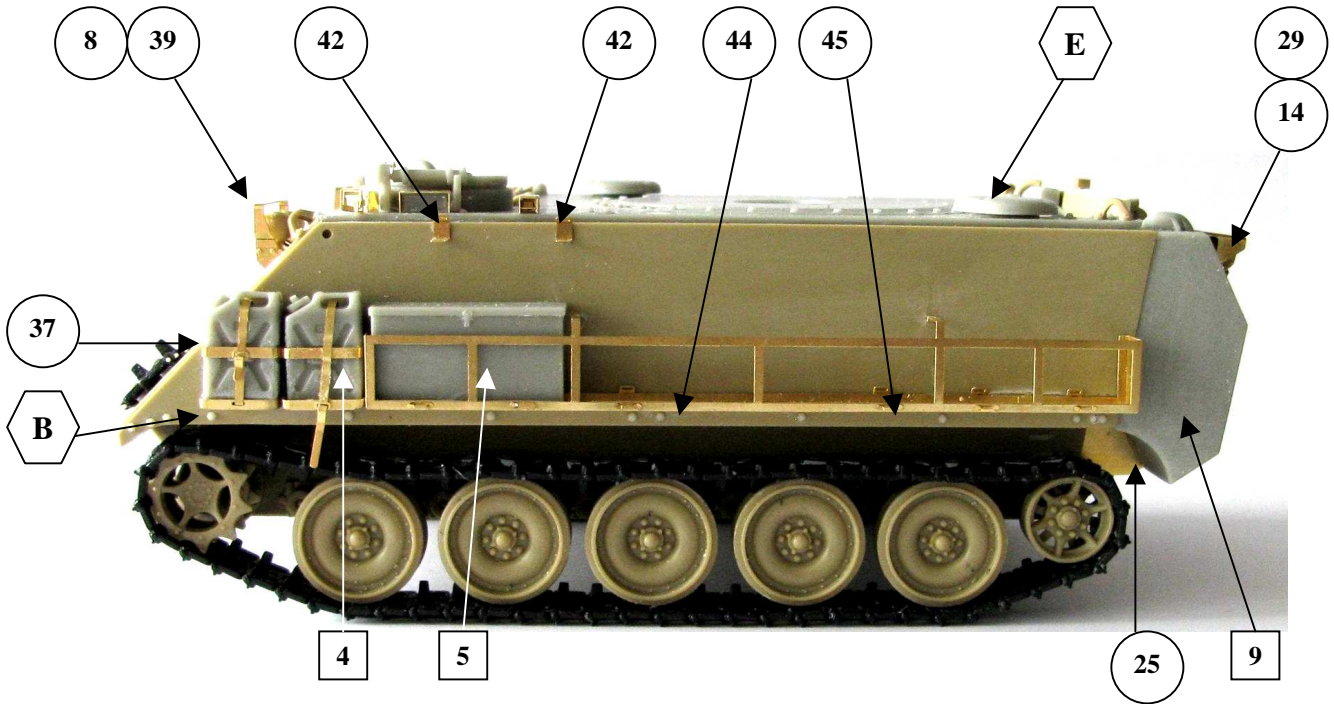



**M-113 Samson 1/35 F3060
Conversion set**

F3060

7/10

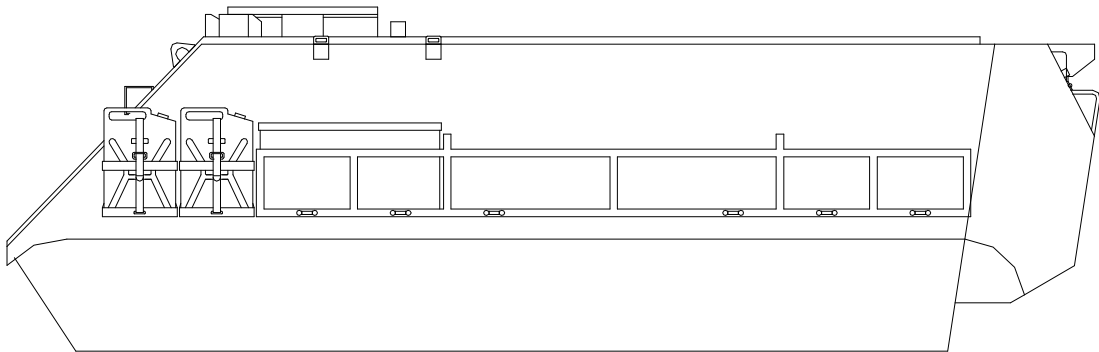
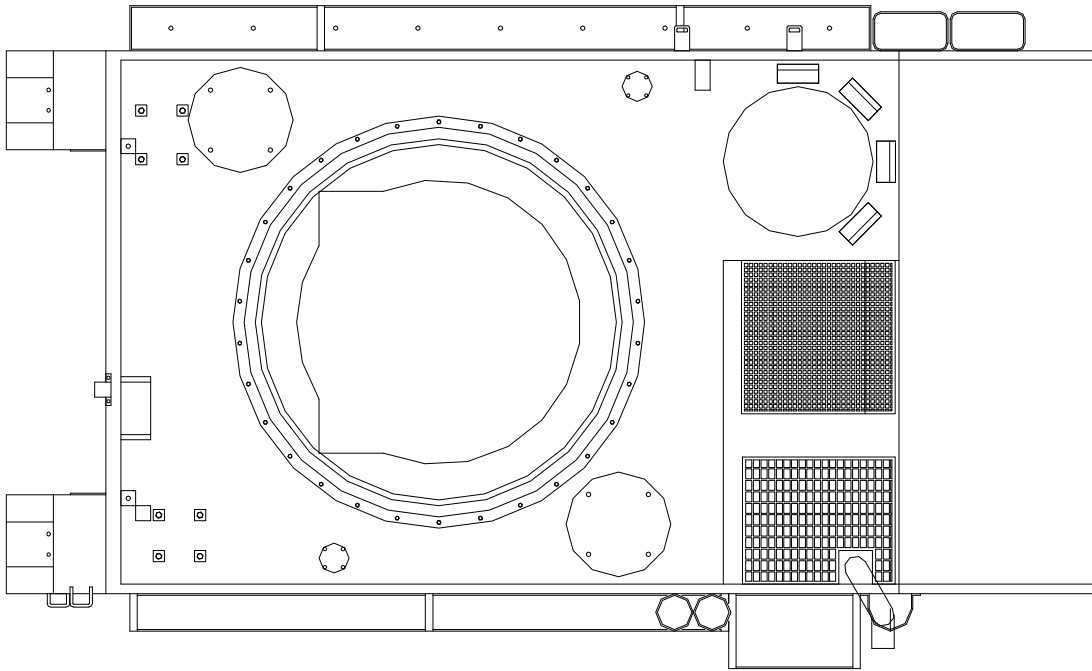
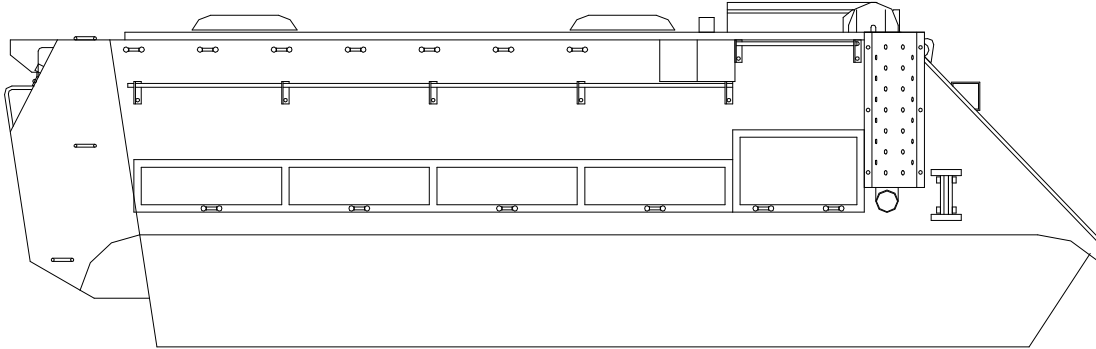

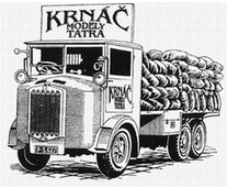

M-113 Samson 1/35 F3060 Conversion set

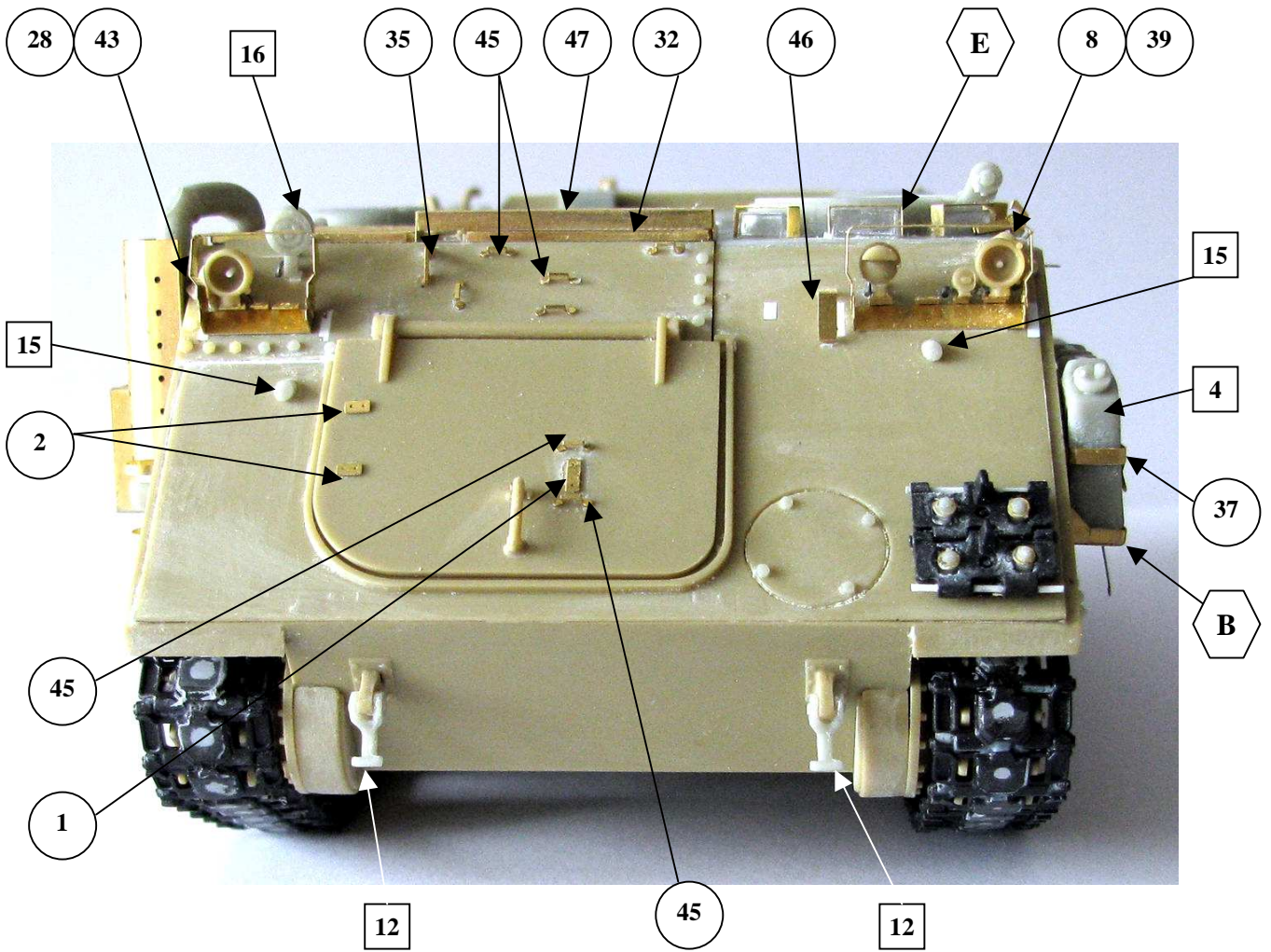

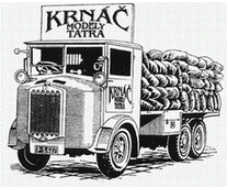

M-113 Samson 1/35 F3060 Conversion set

9/10

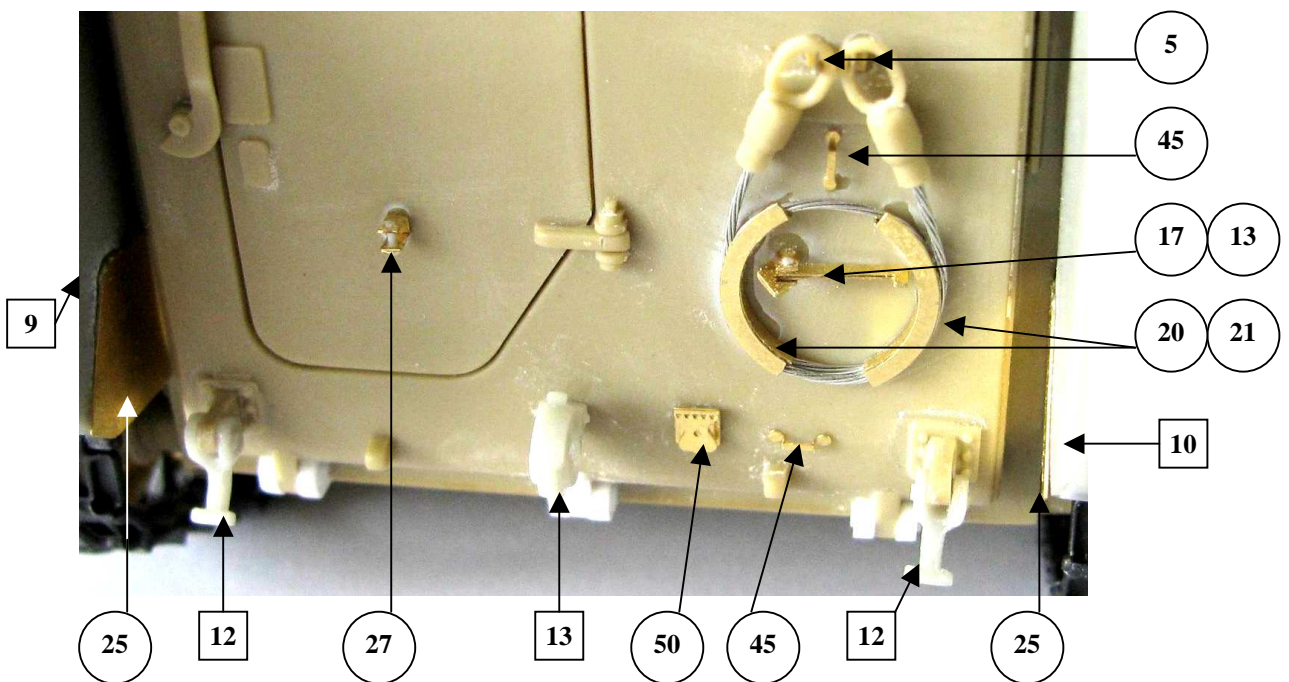
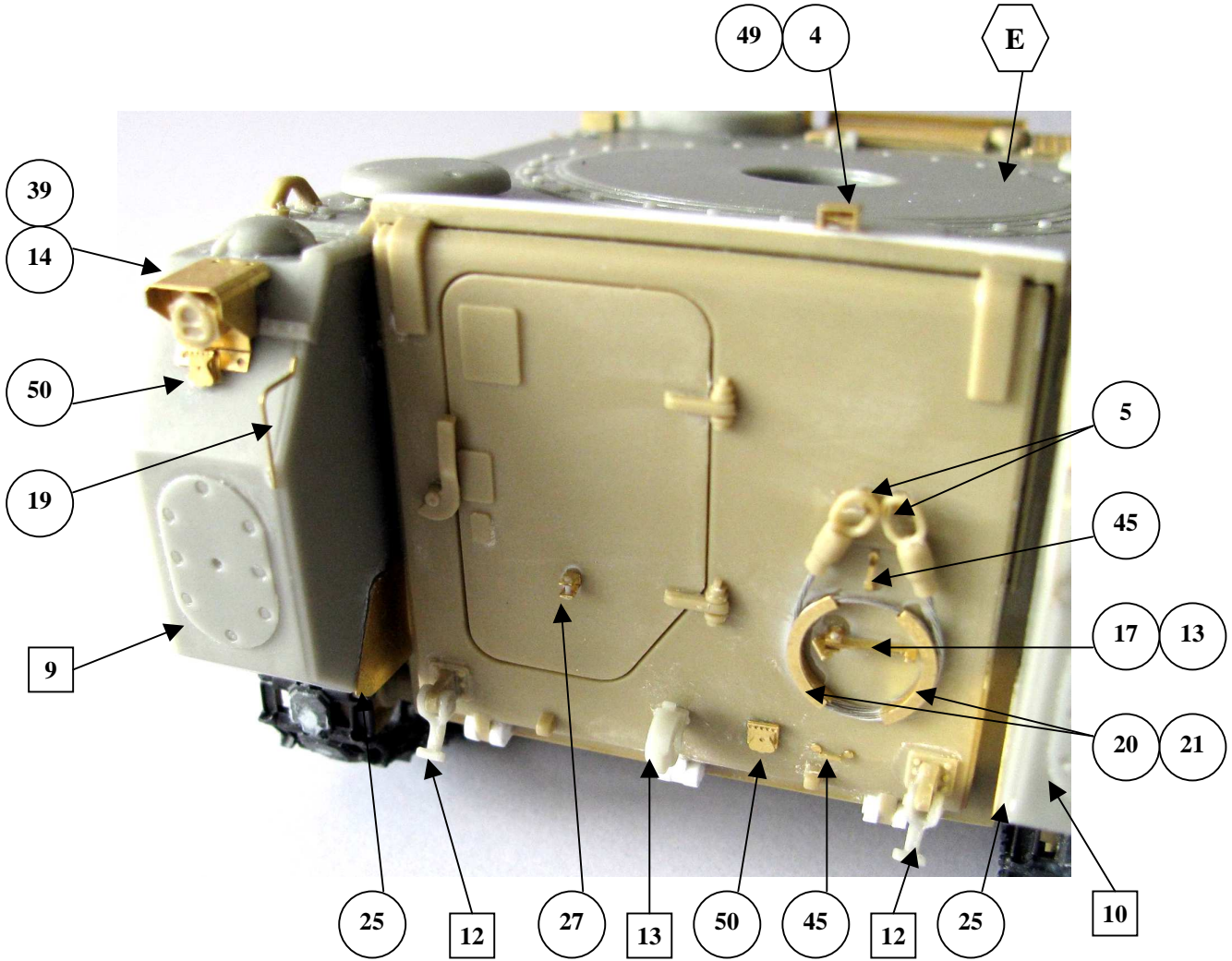

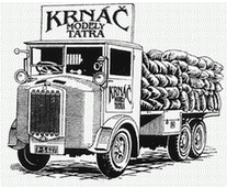

M-113 Samson 1/35 F3060
Conversion set

10/10

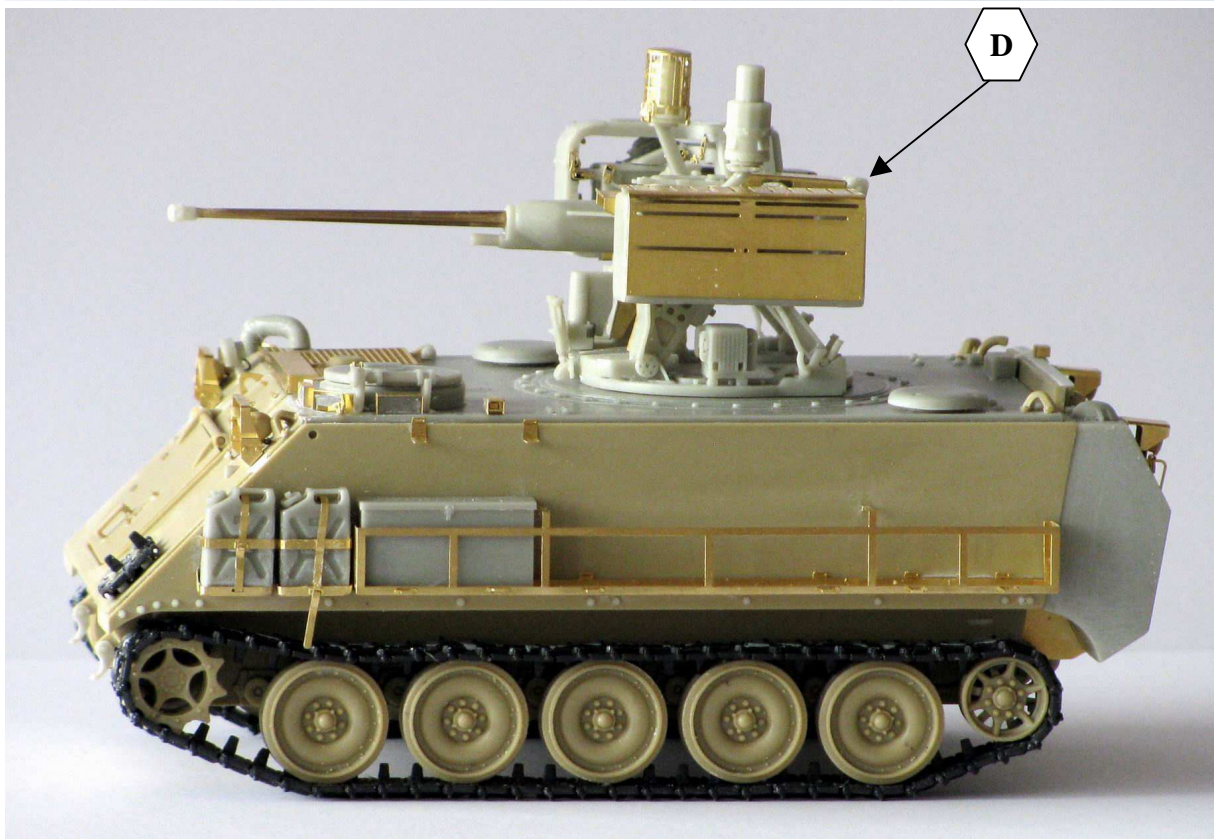
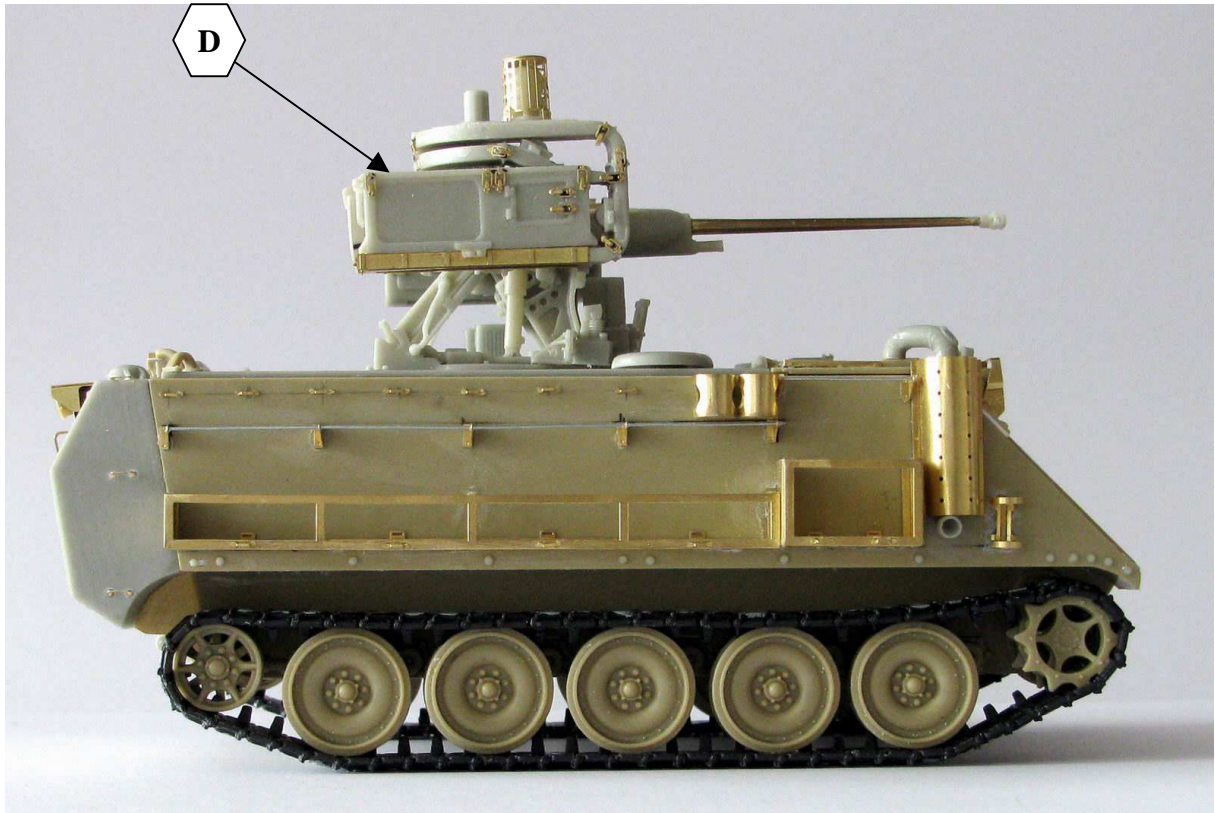

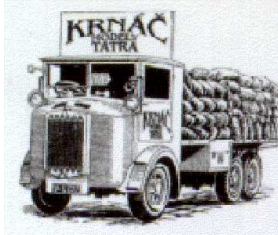

MMK Folknáře 70 40501 Děčín www.mmk.cz mk.model@volny.cz

SAMSON RCWS 30



