

MMK Folknáře 70 40501 Děčín [www.mmk.cz](http://www.mmk.cz) [mk.model@volny.cz](mailto:mk.model@volny.cz)

## TATRA T 148 VNM

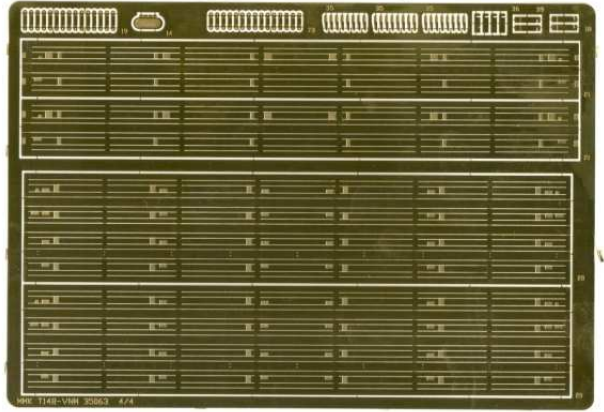
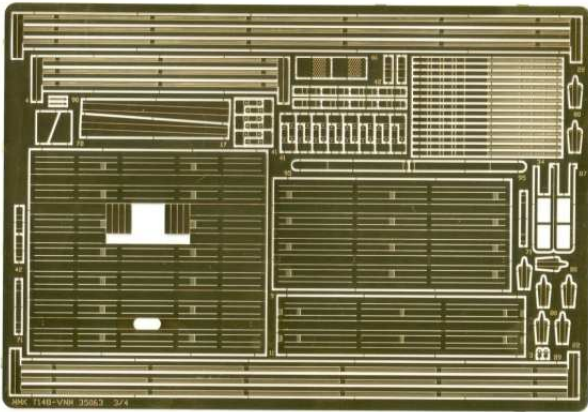
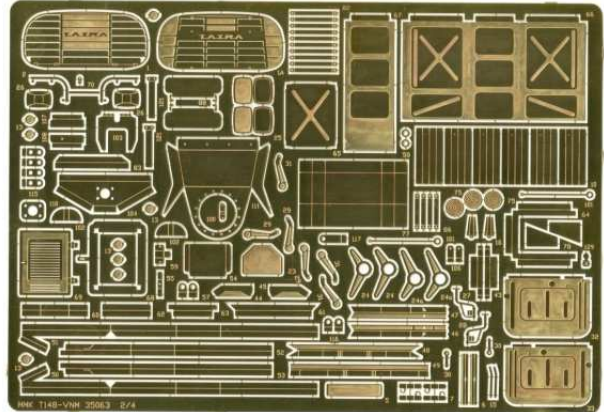
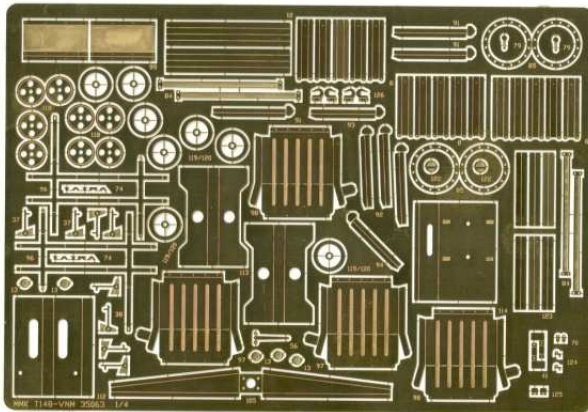

 cast parts

 etched parts



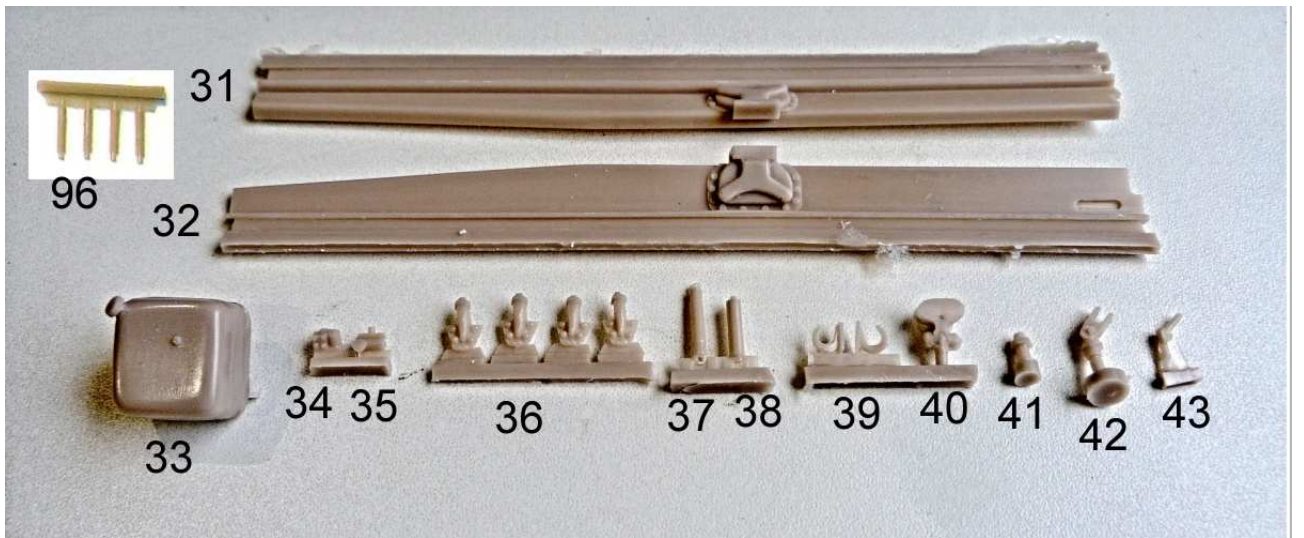
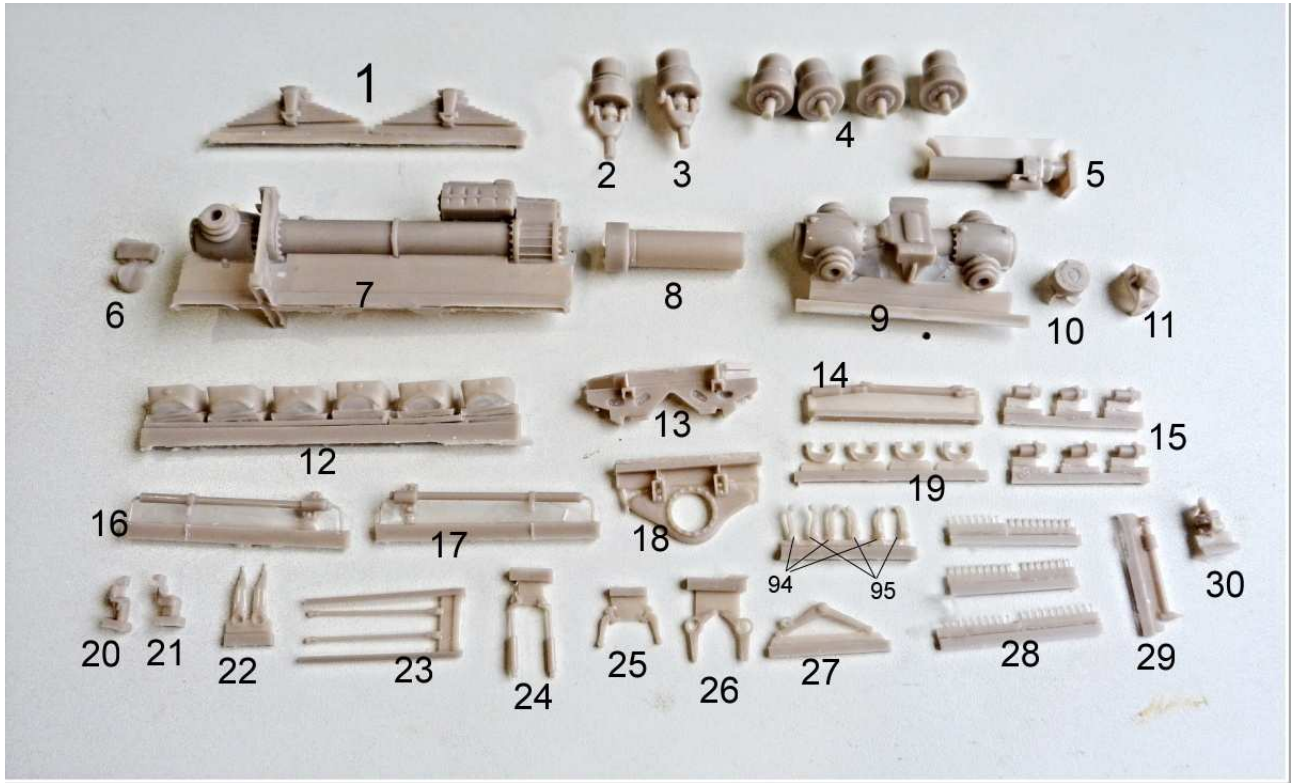

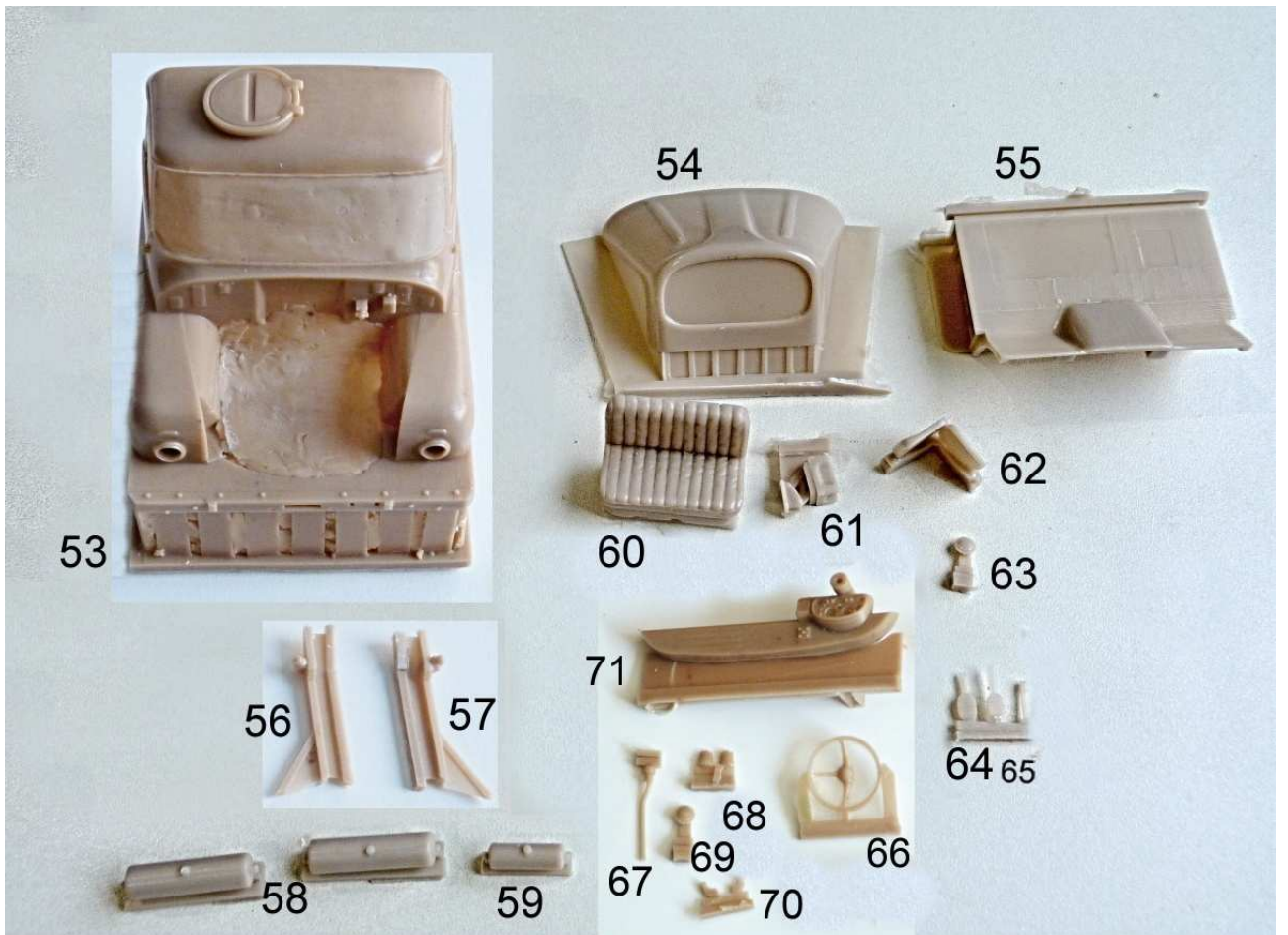
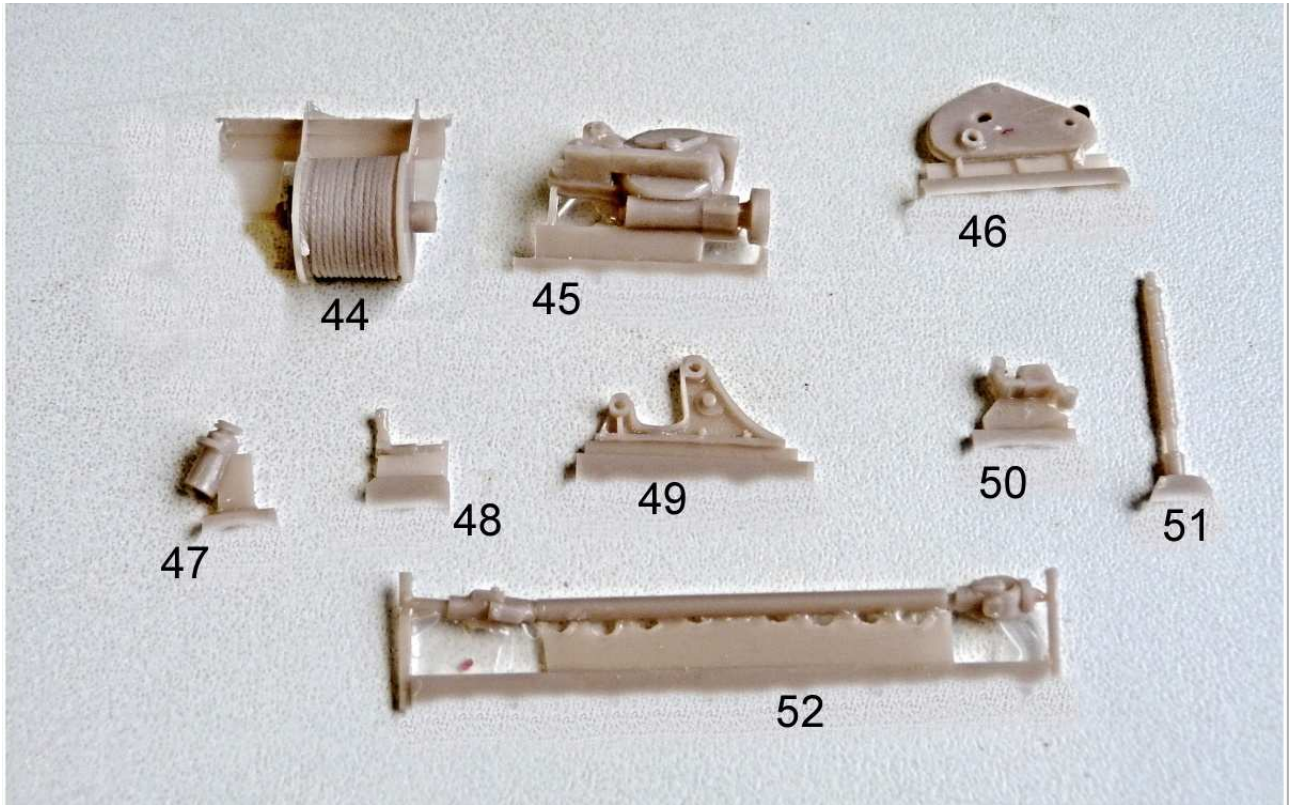

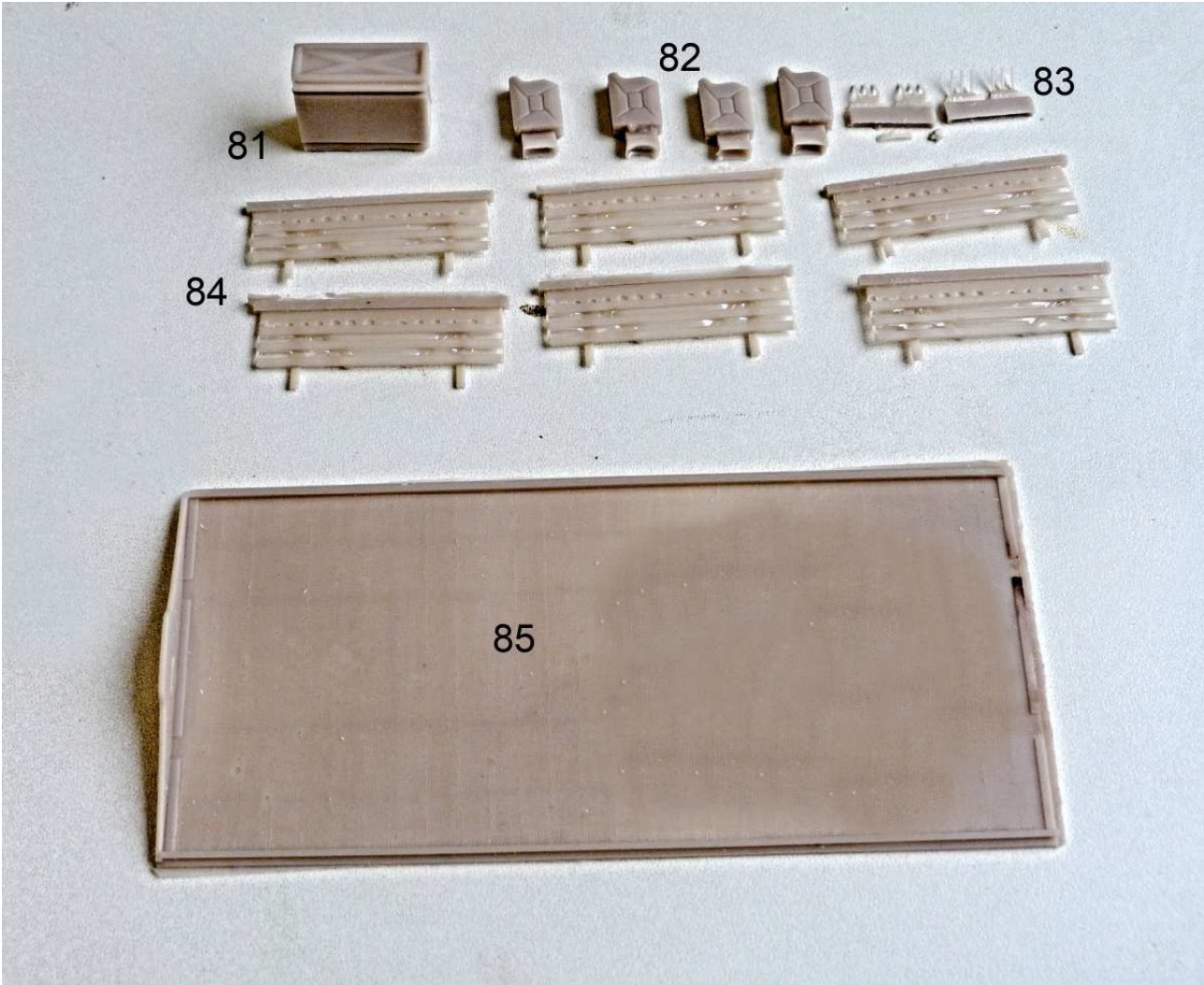
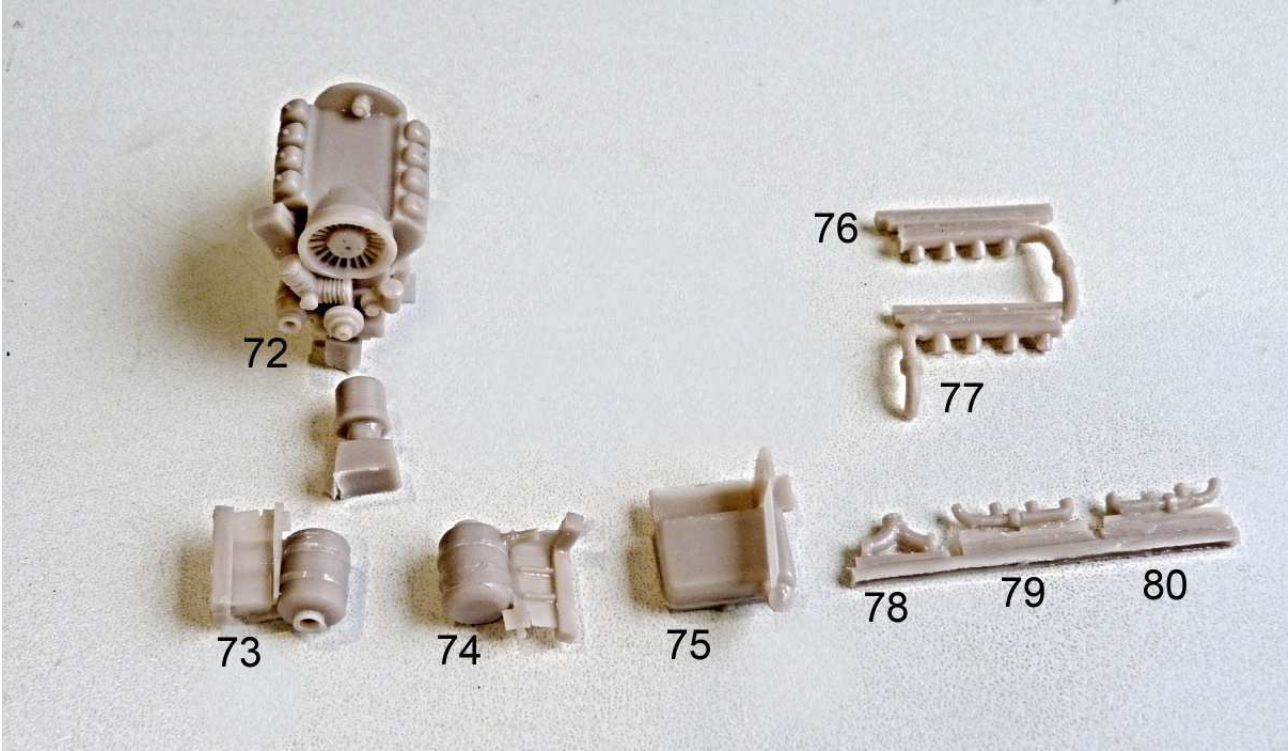

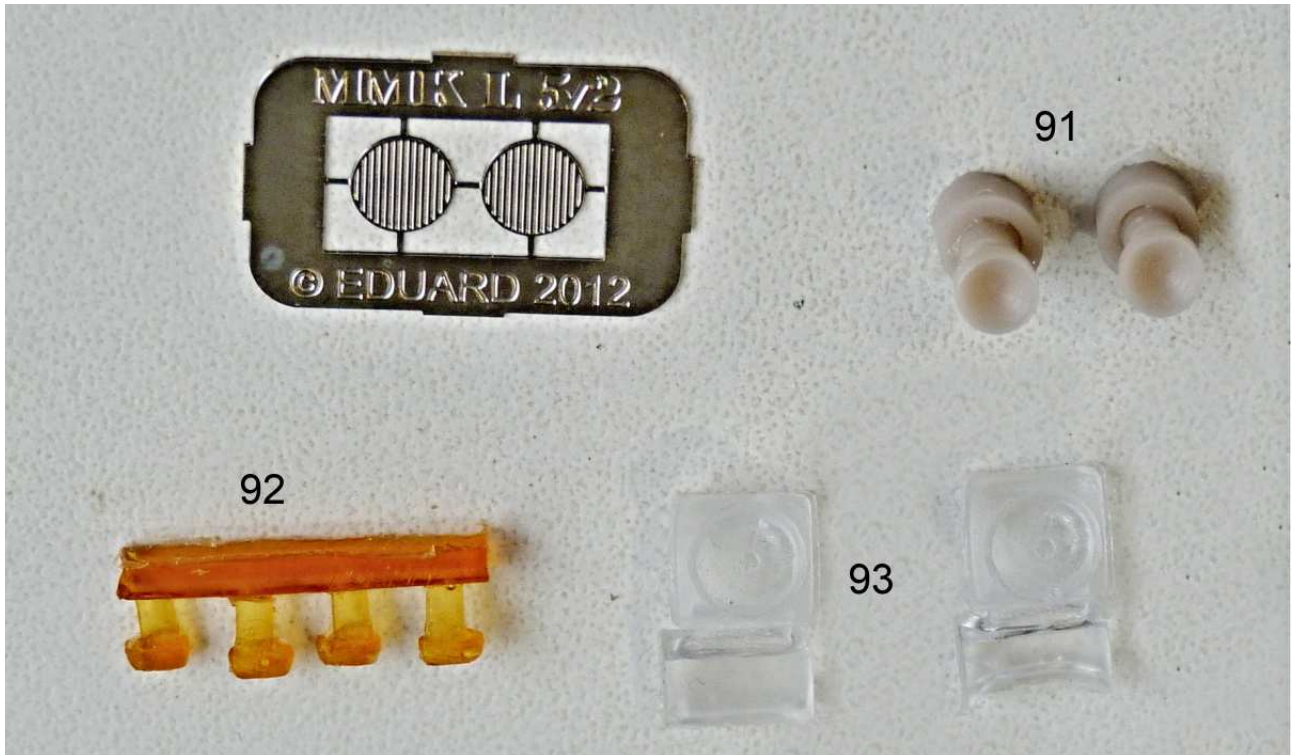
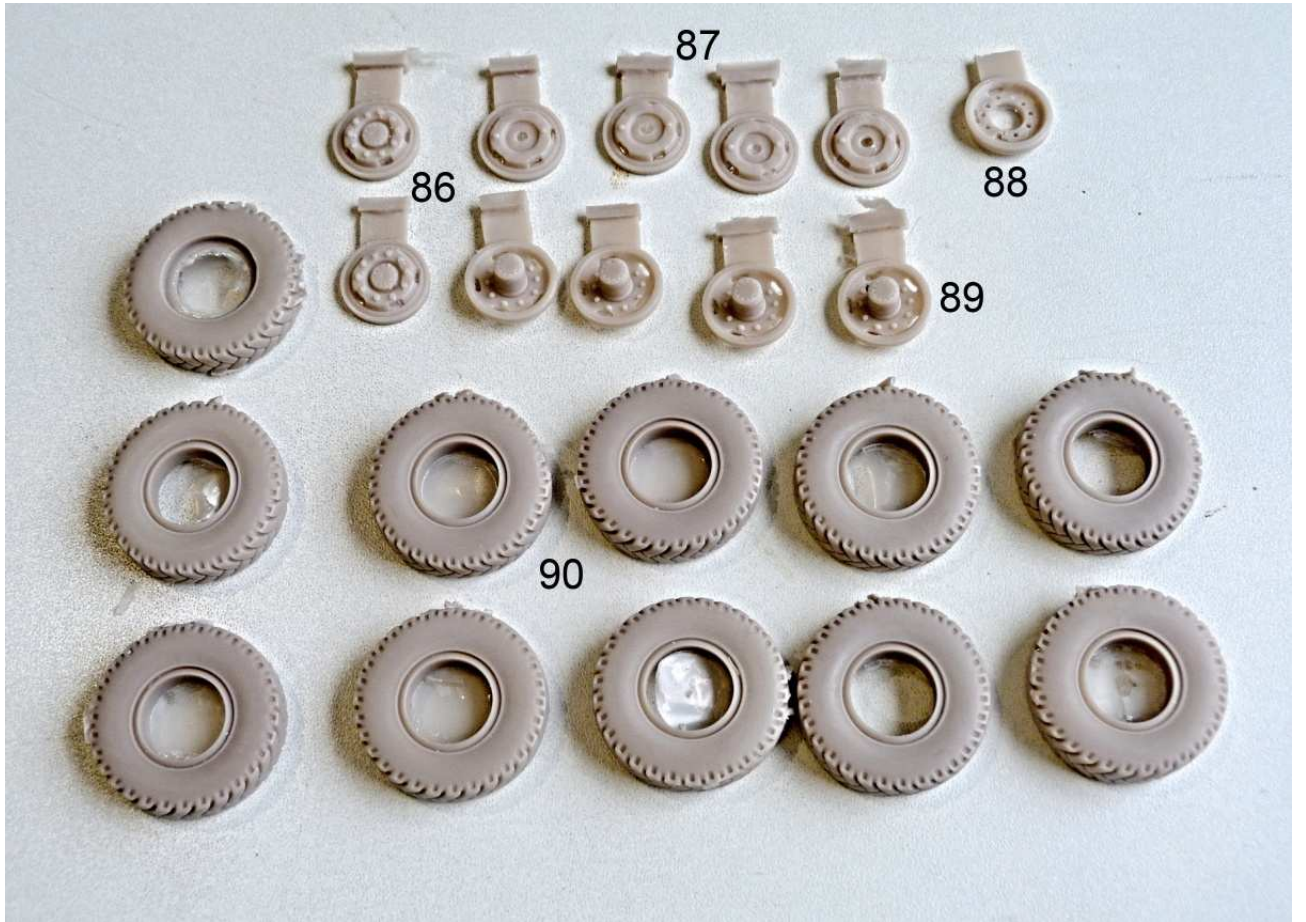

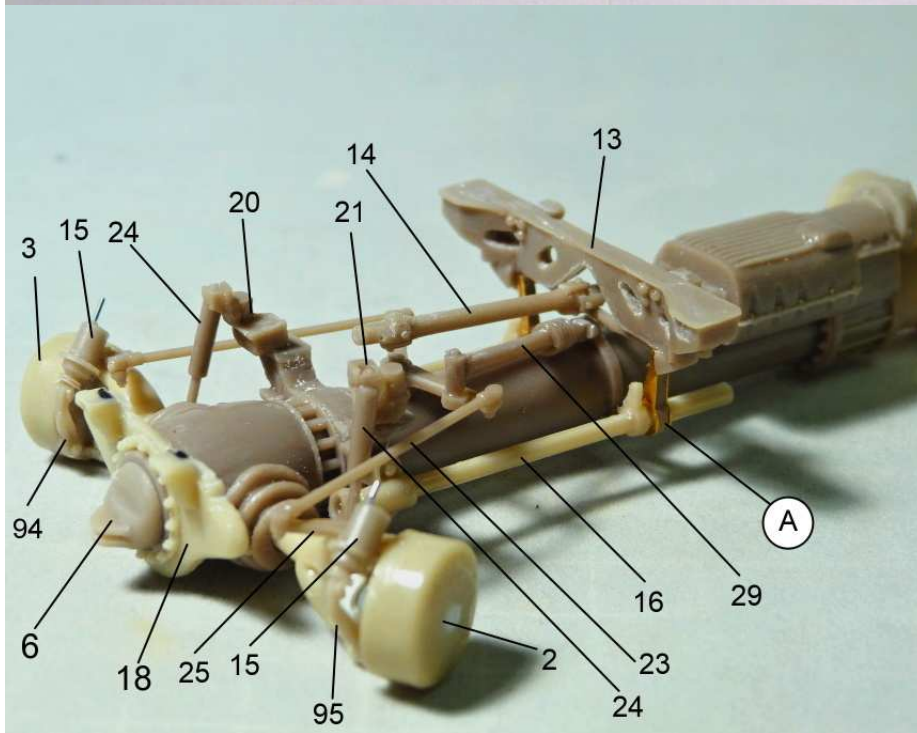
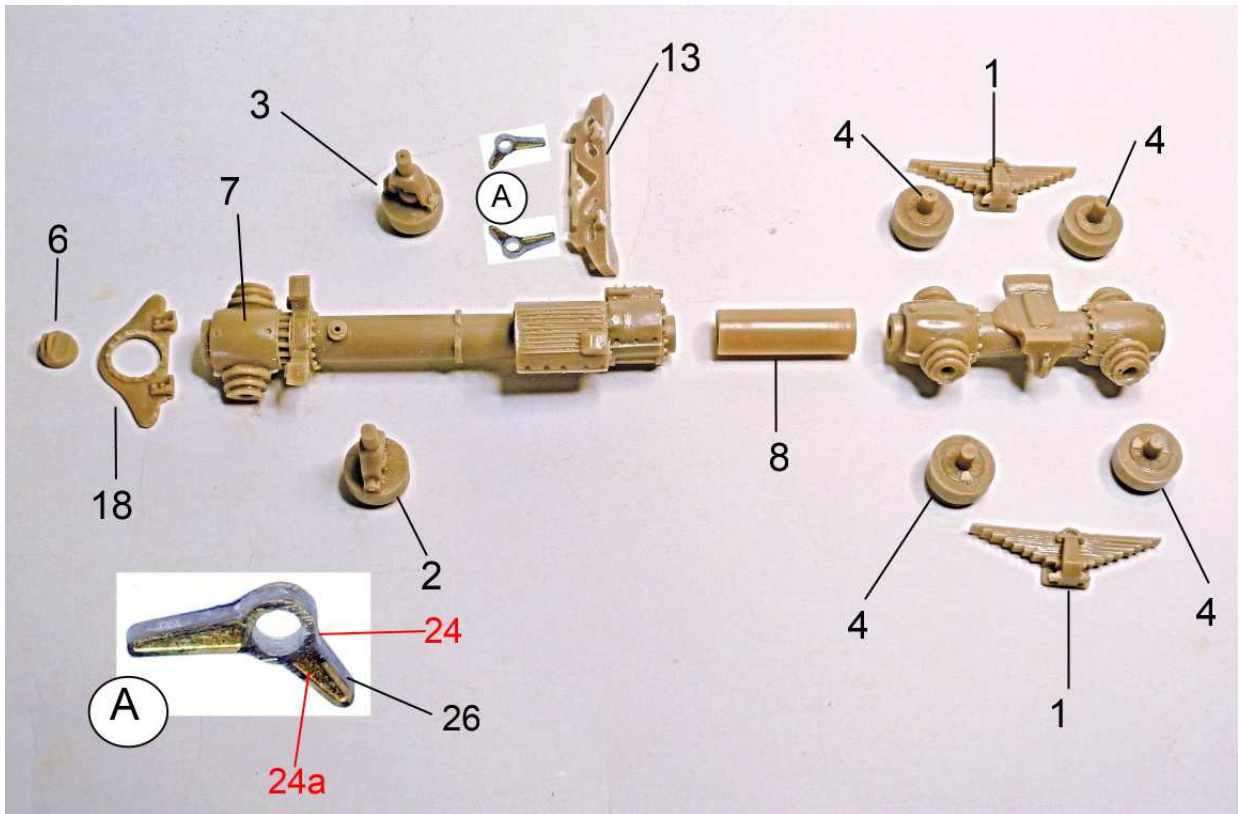

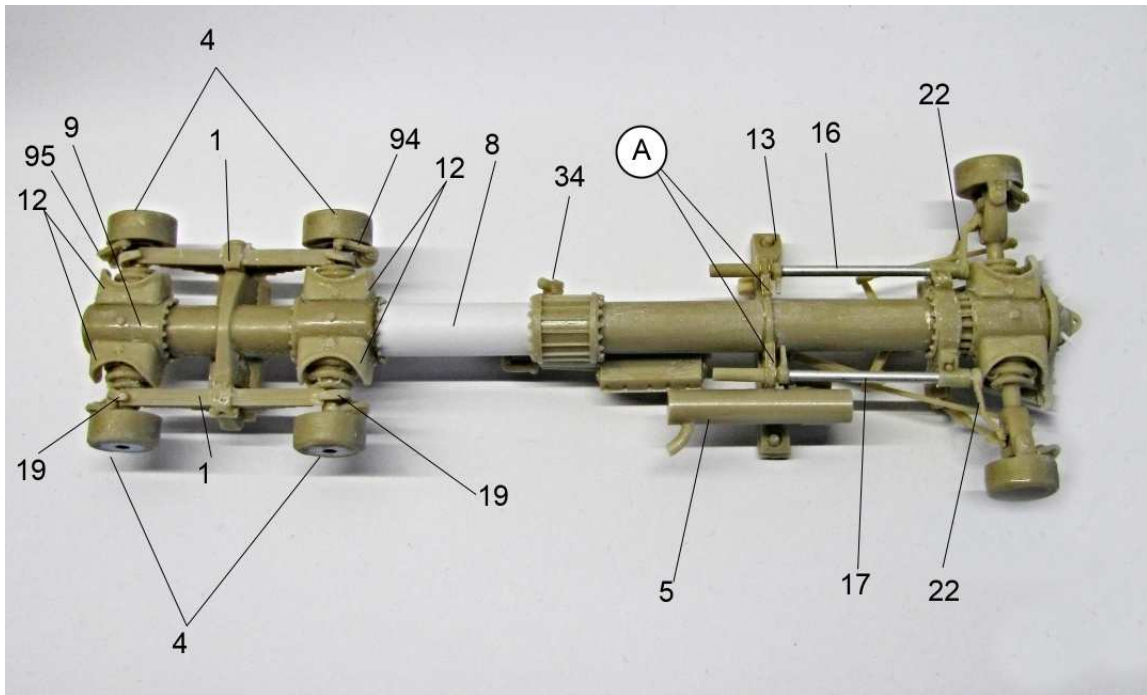
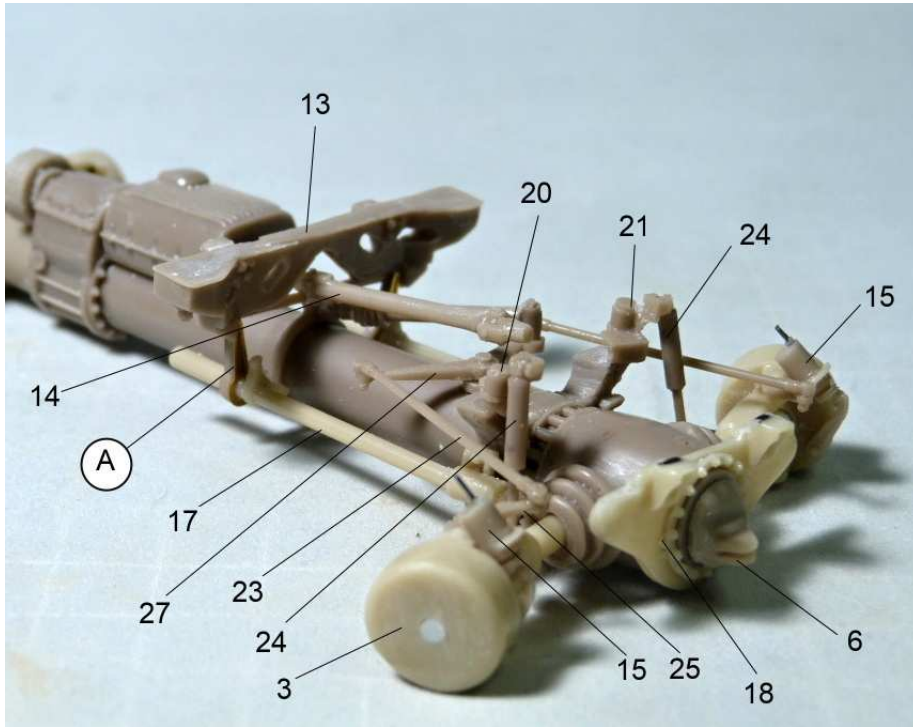

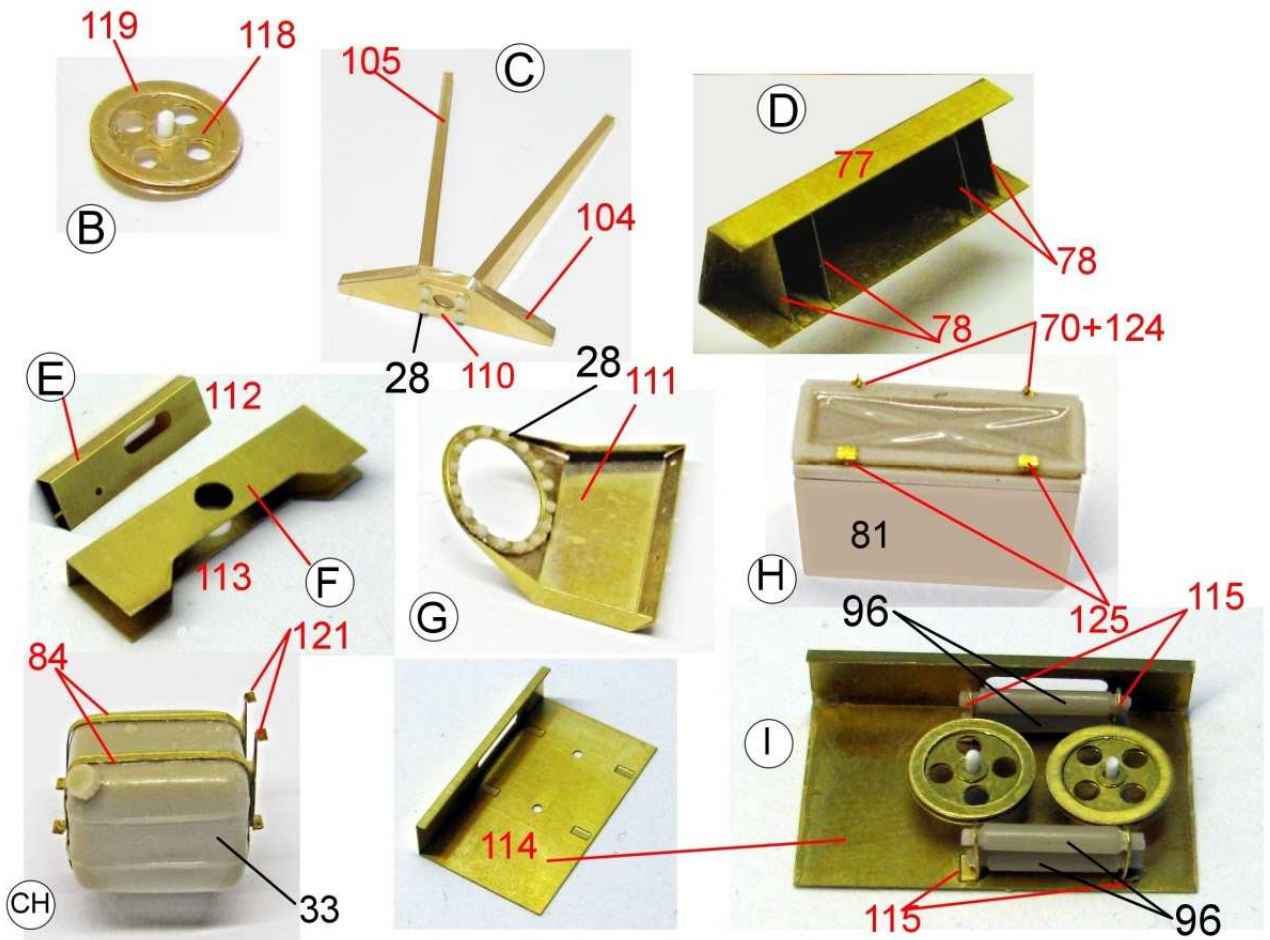
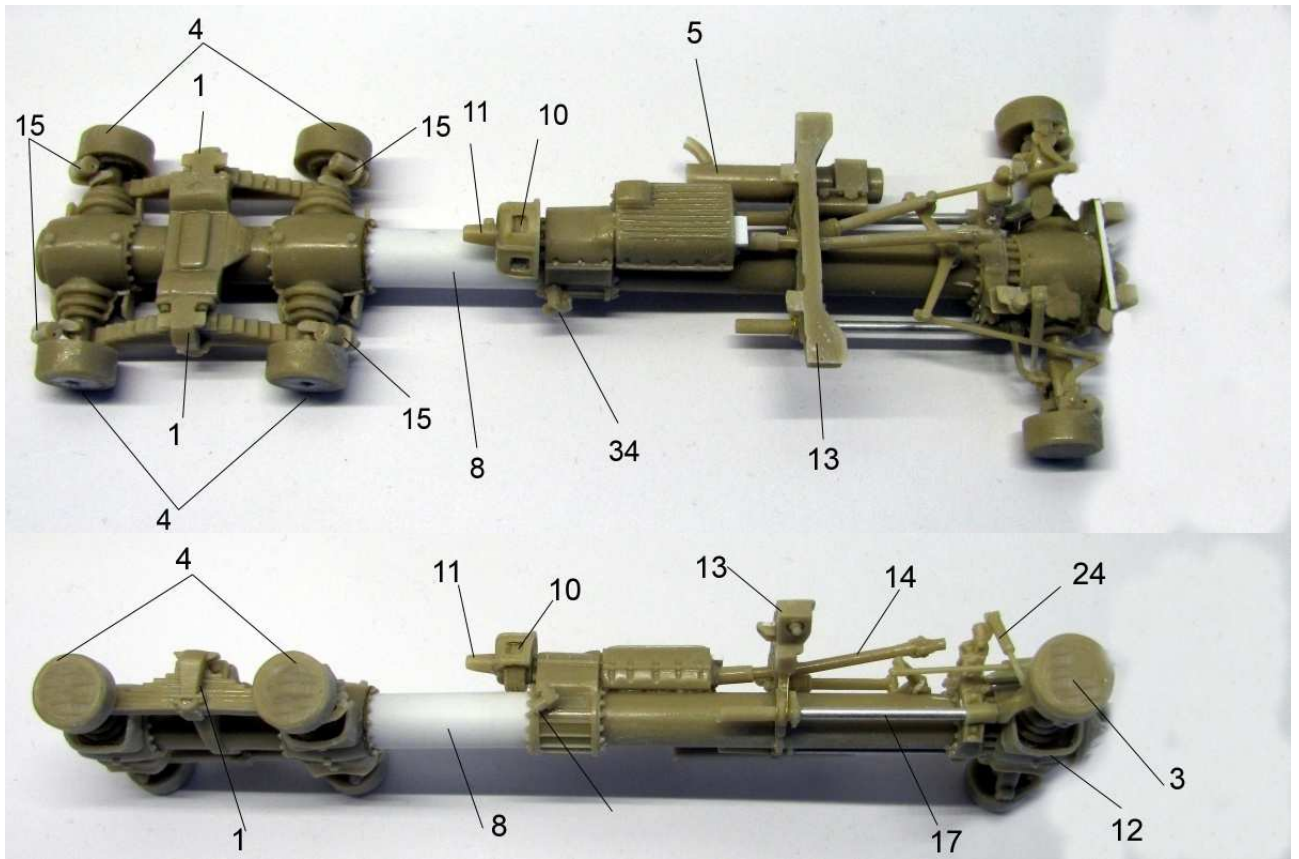



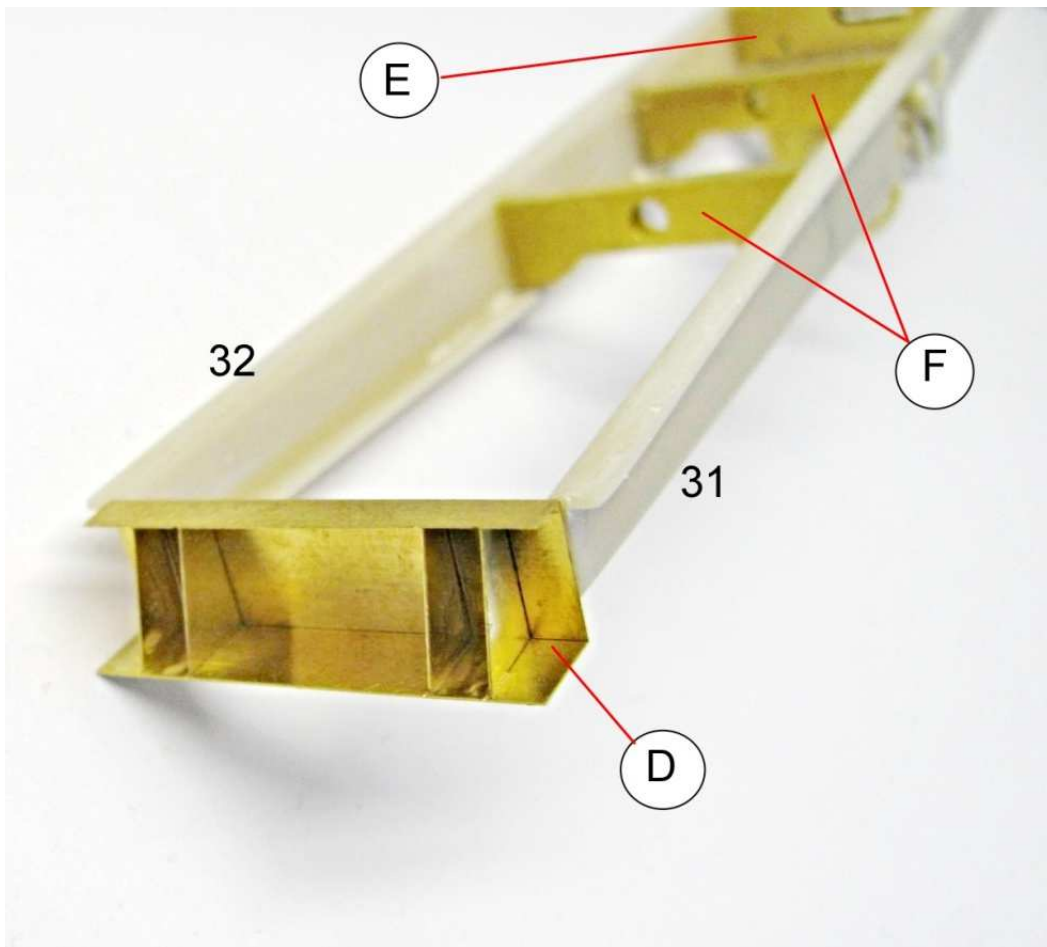
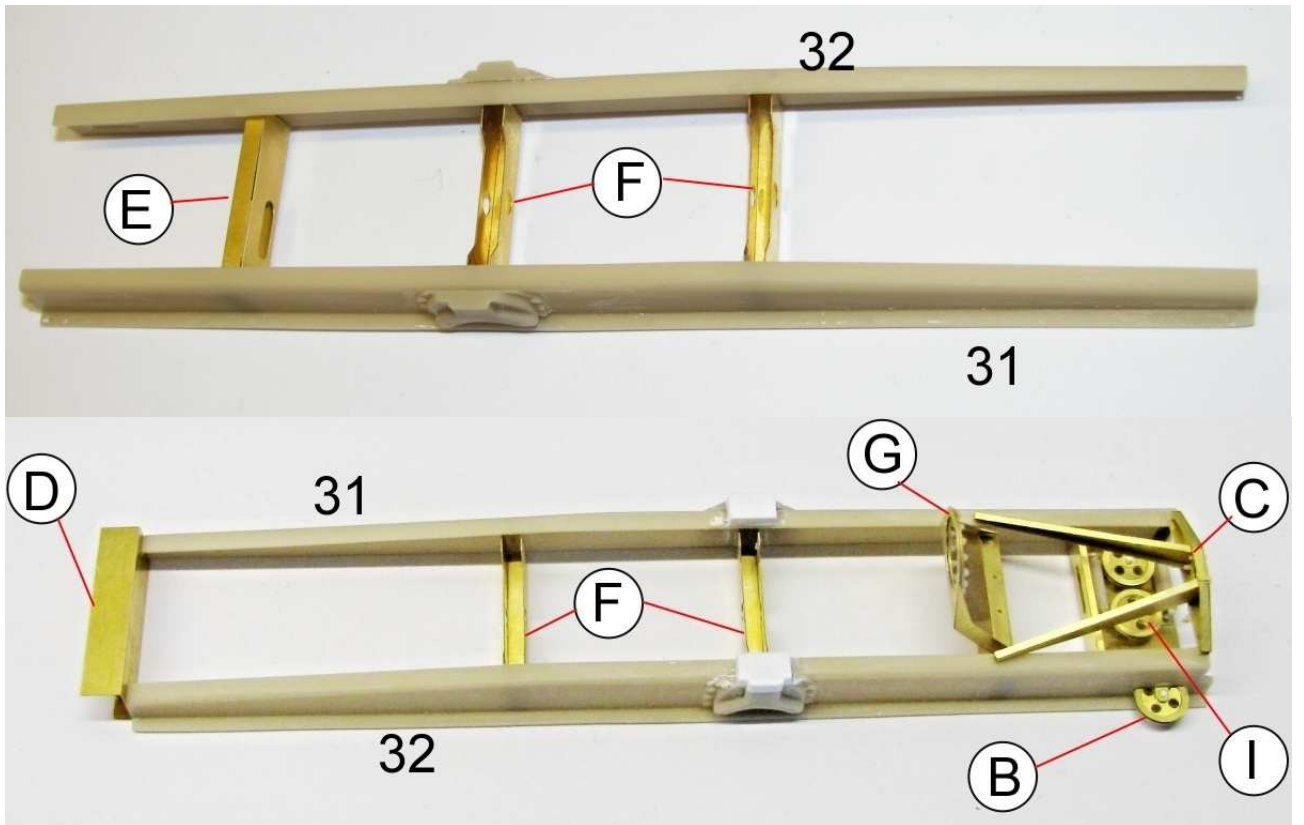

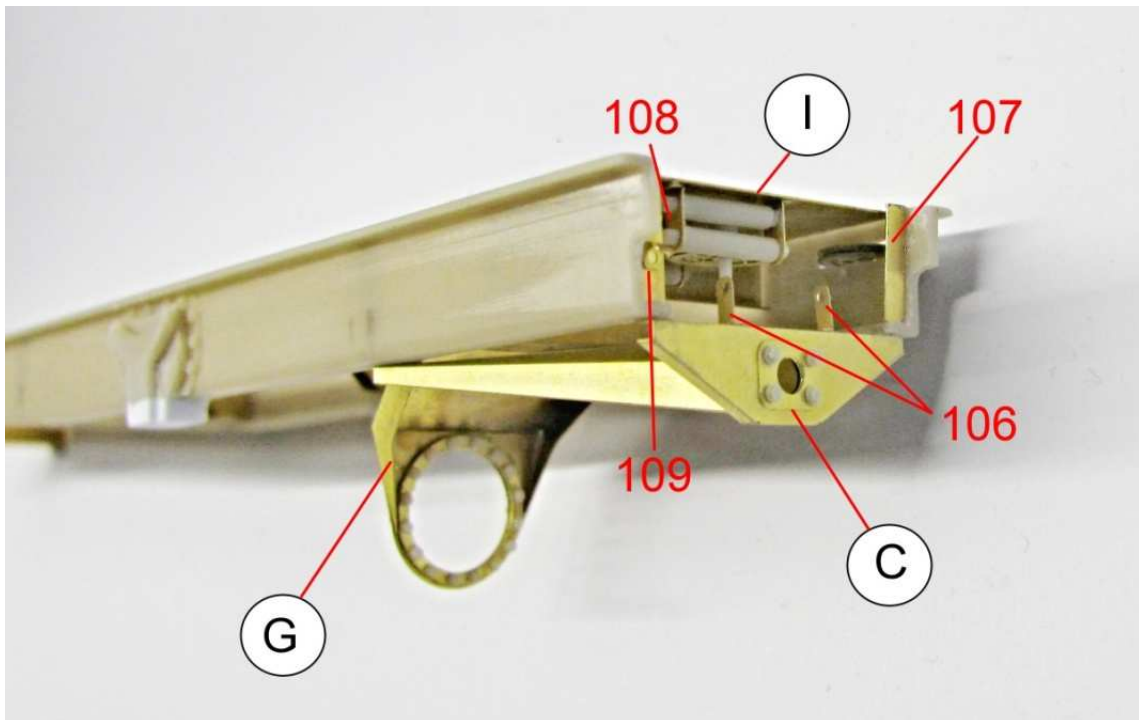
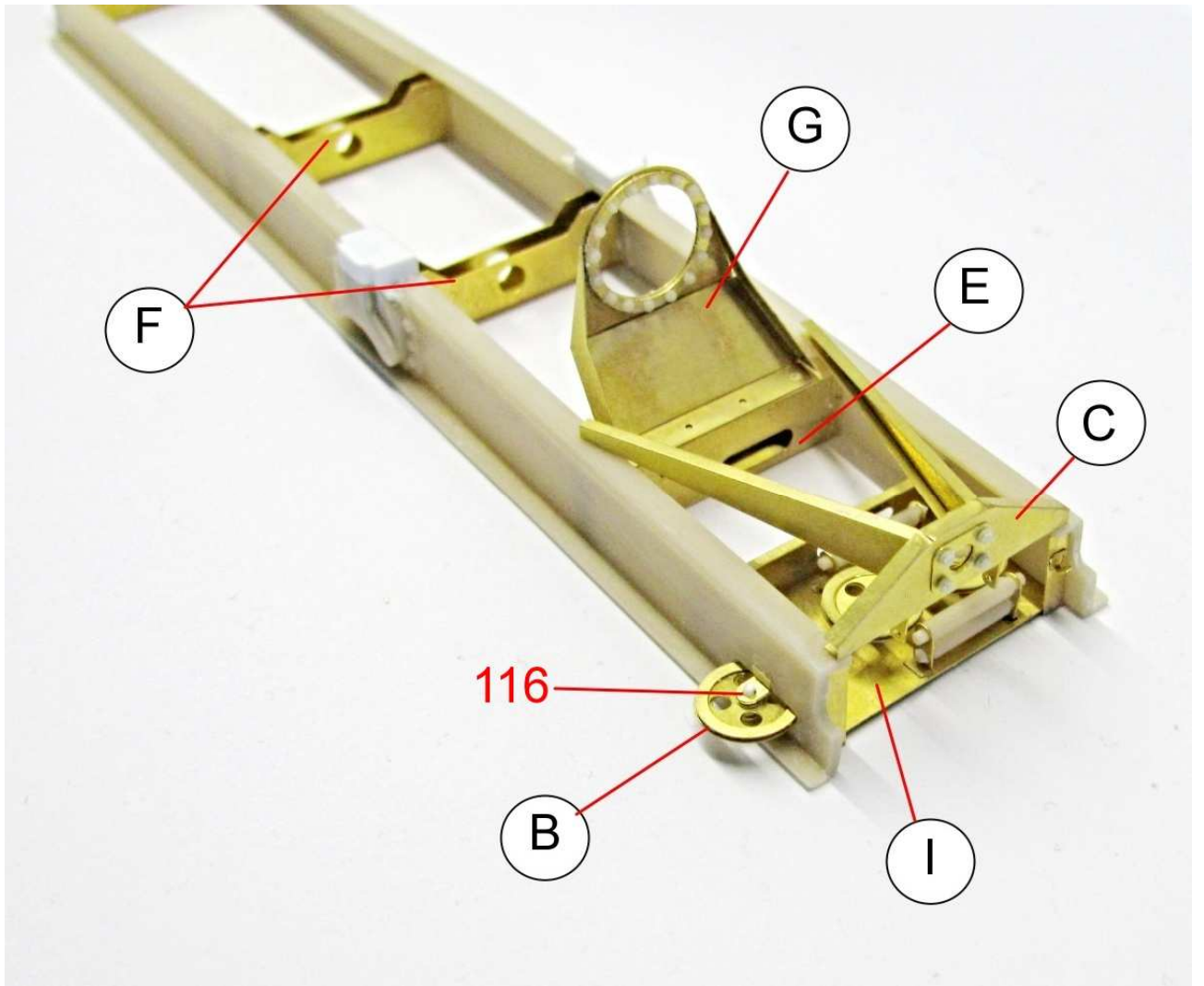

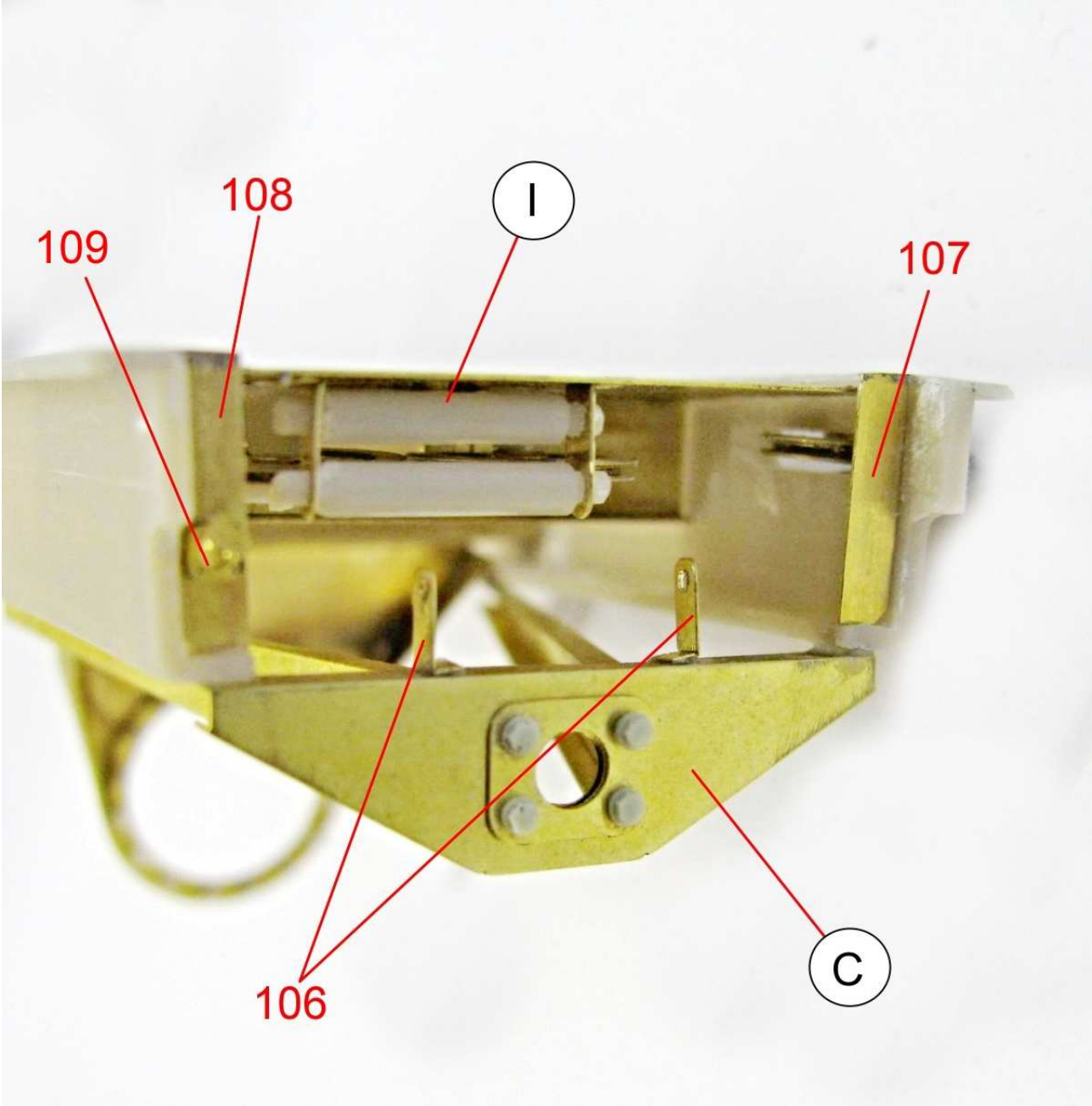

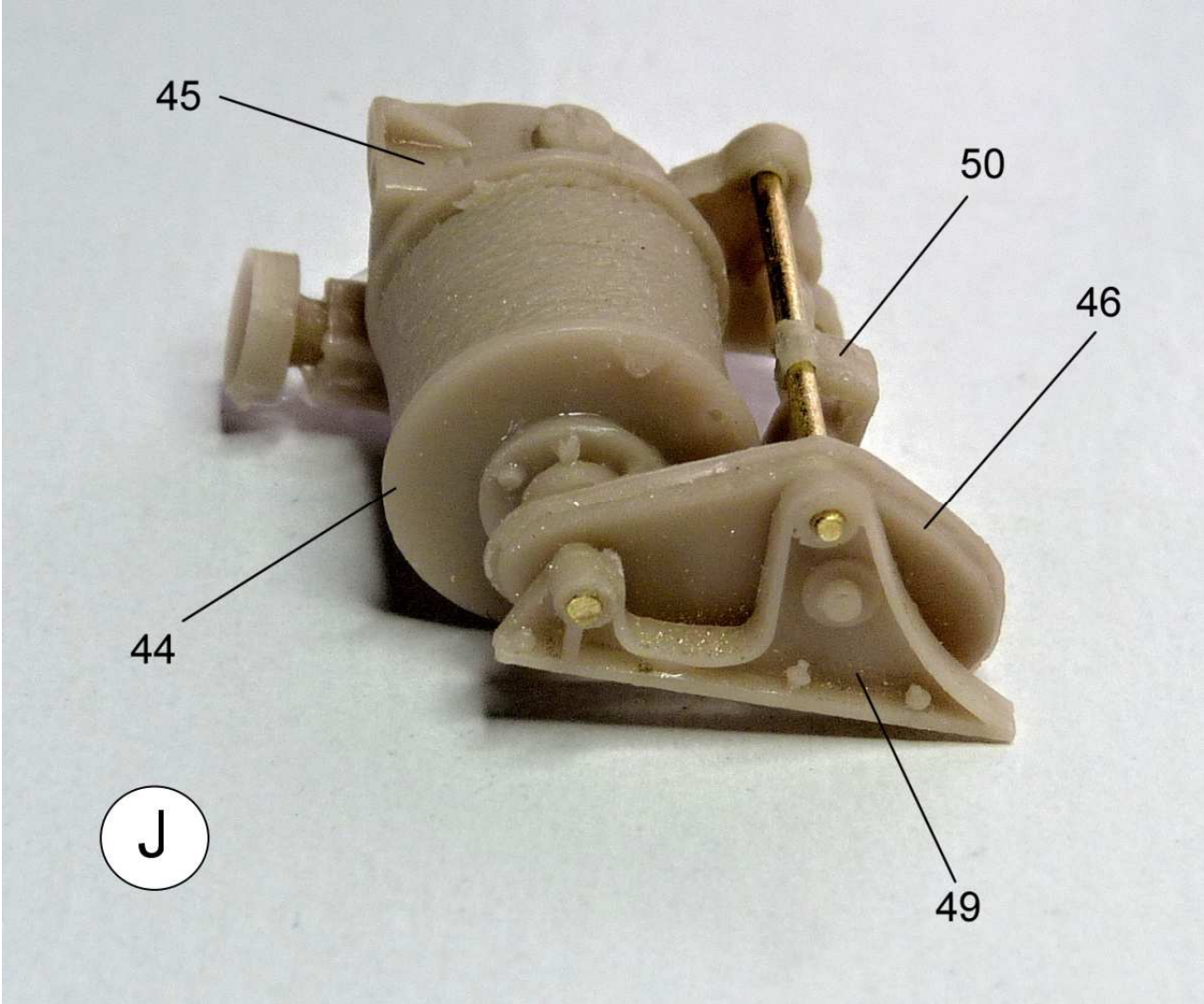

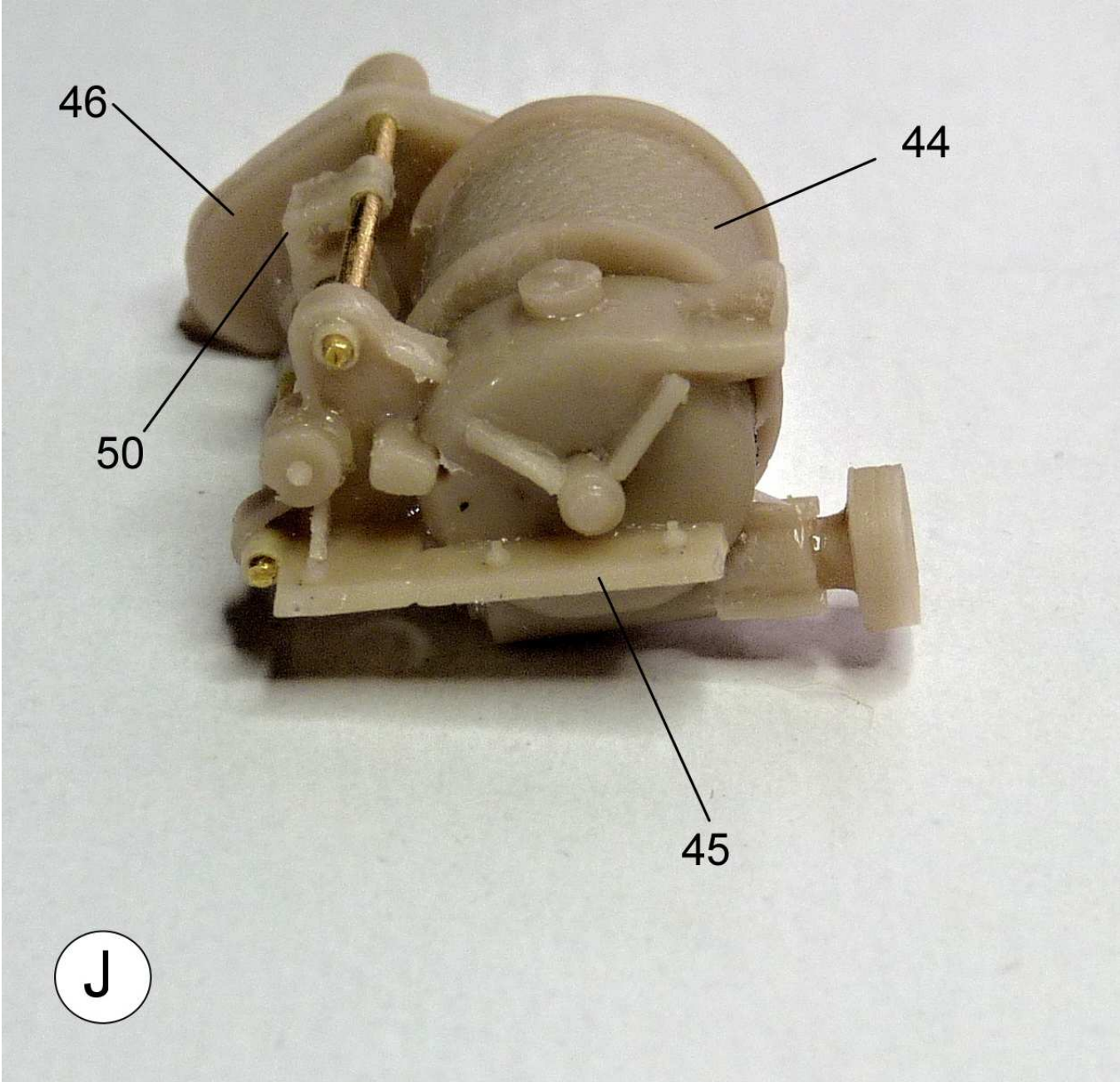

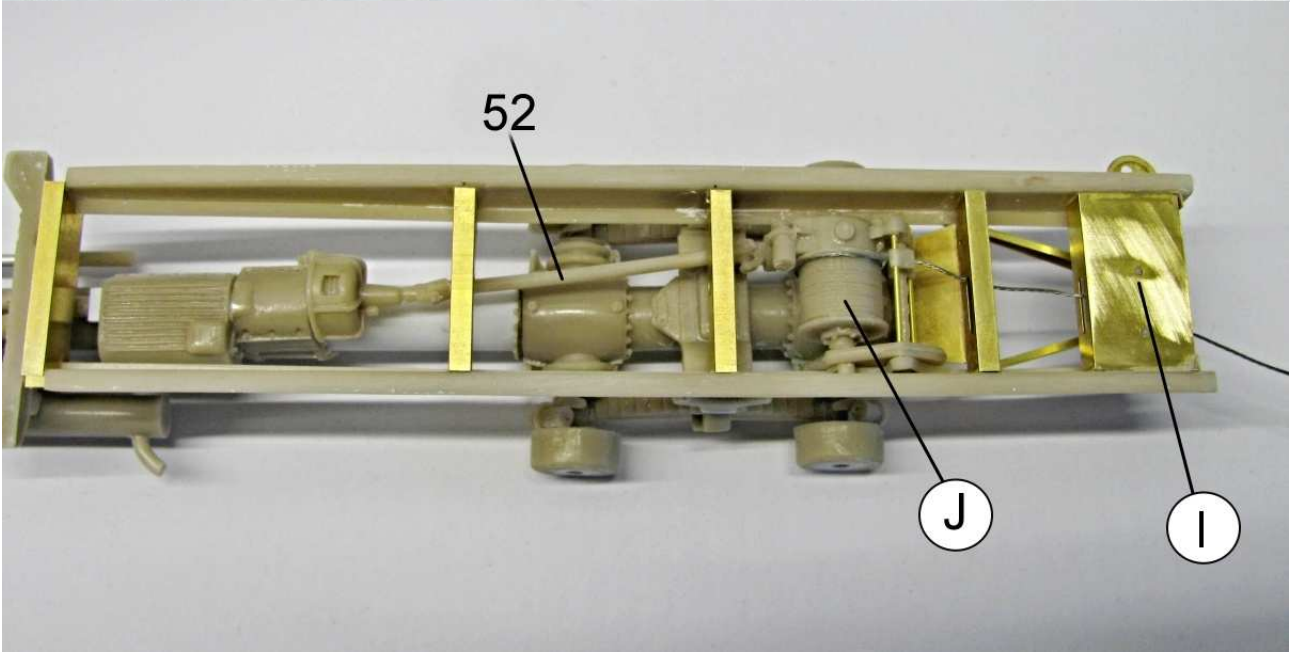
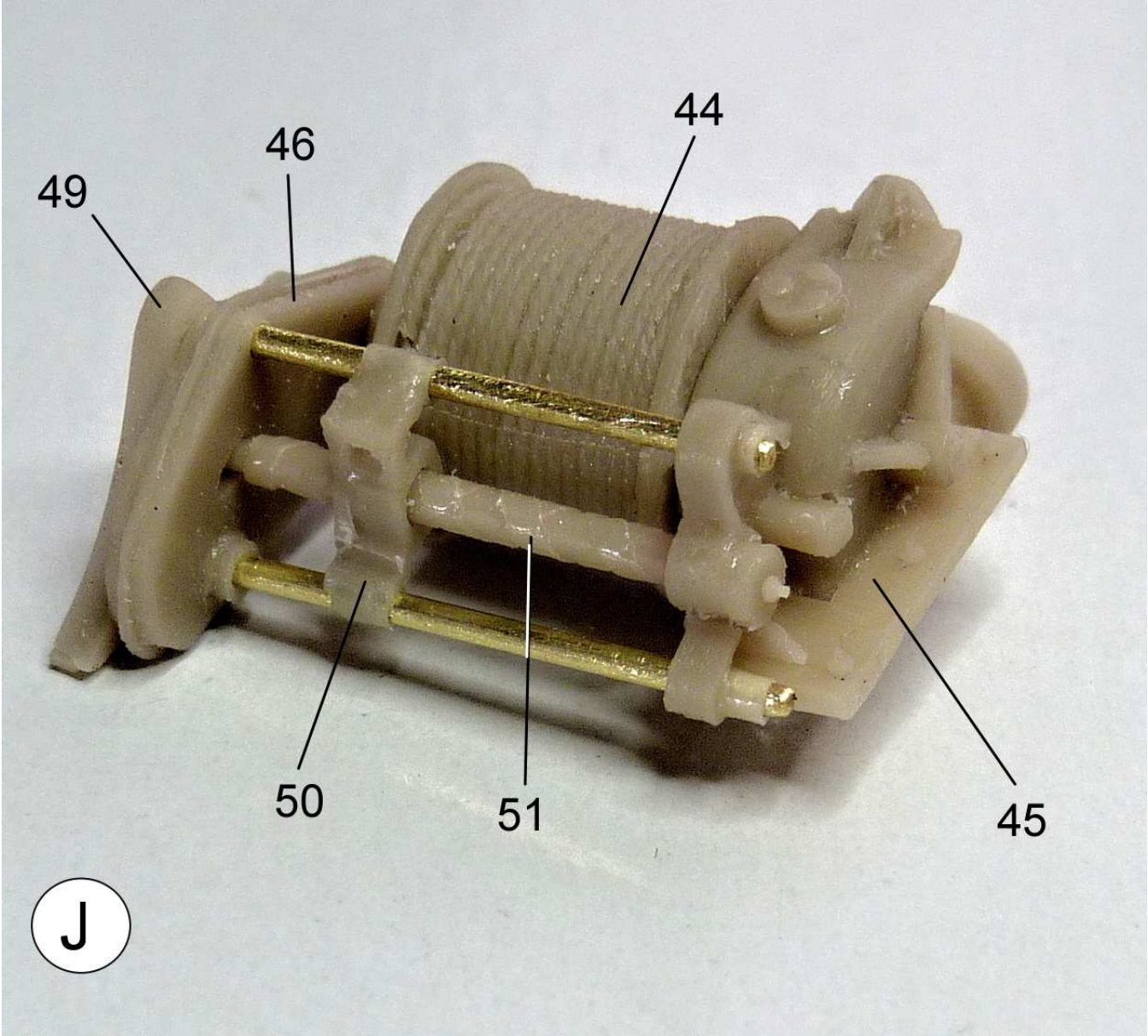

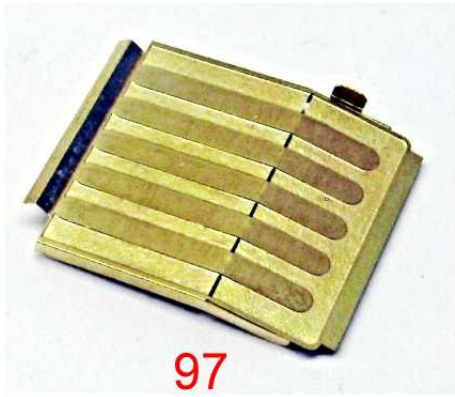

97

98

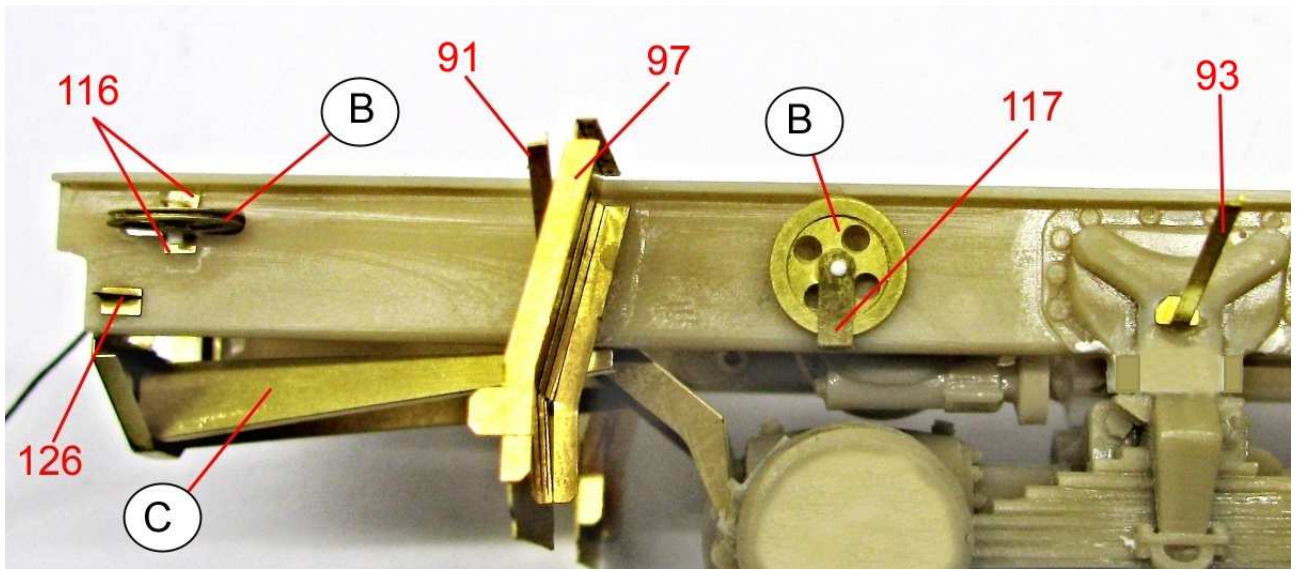
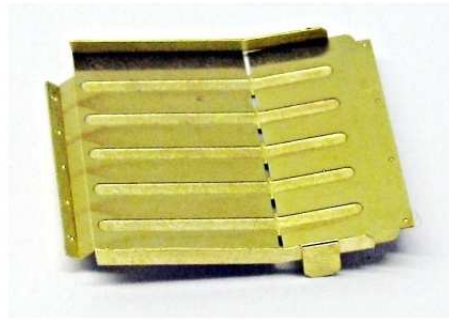

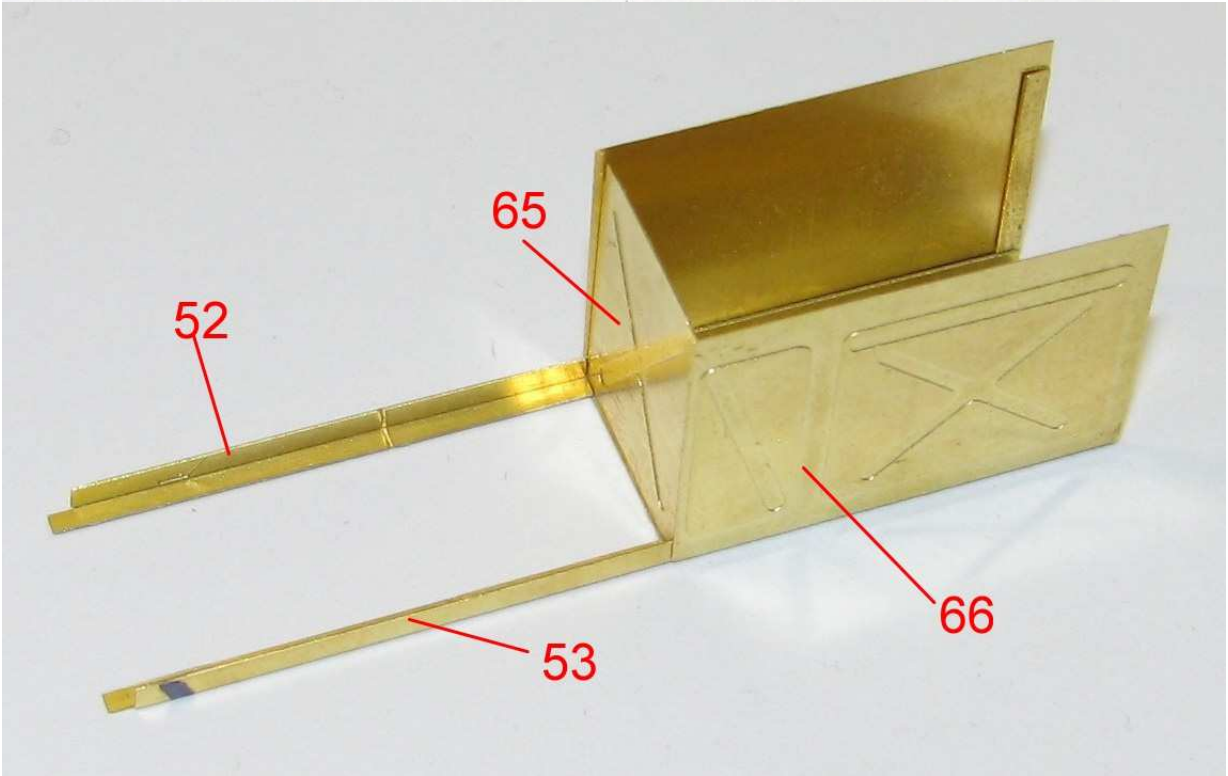
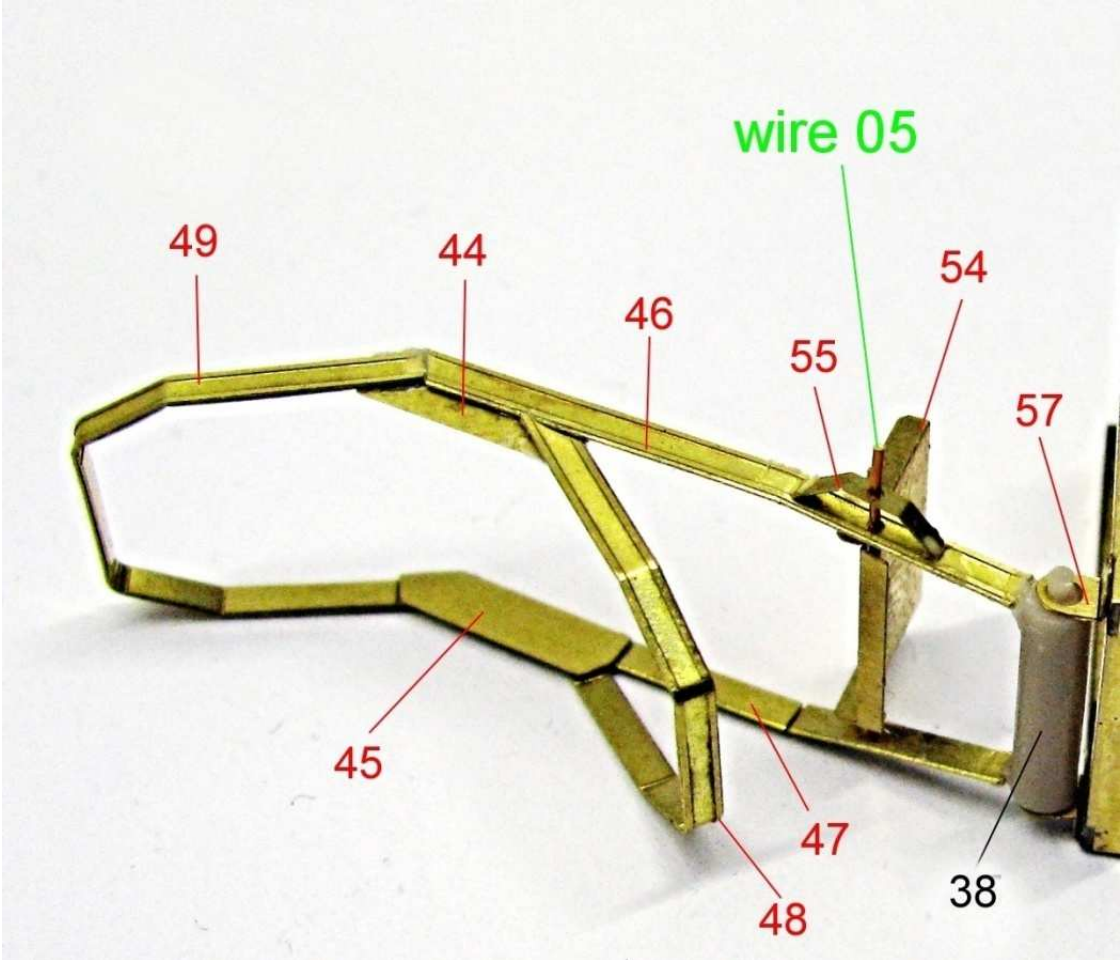



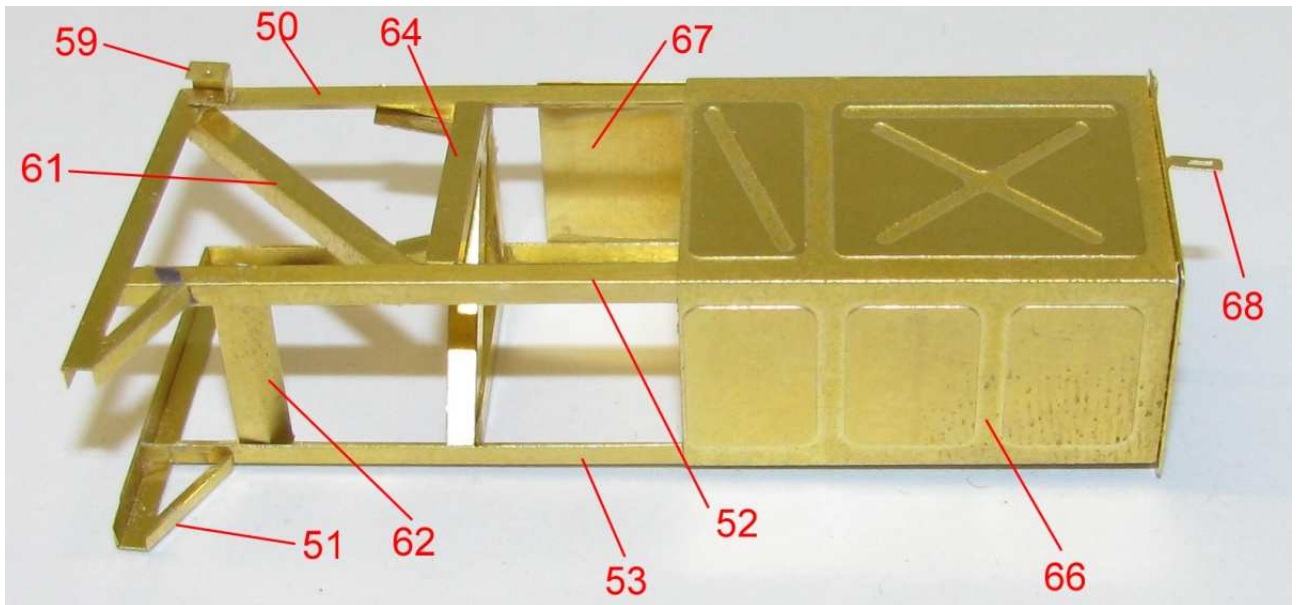
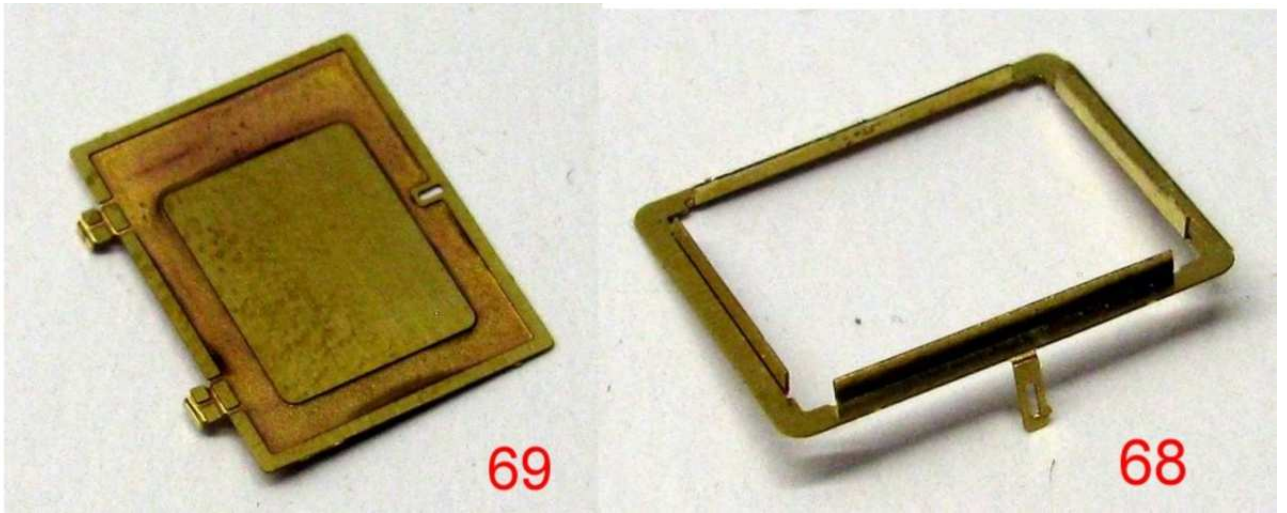

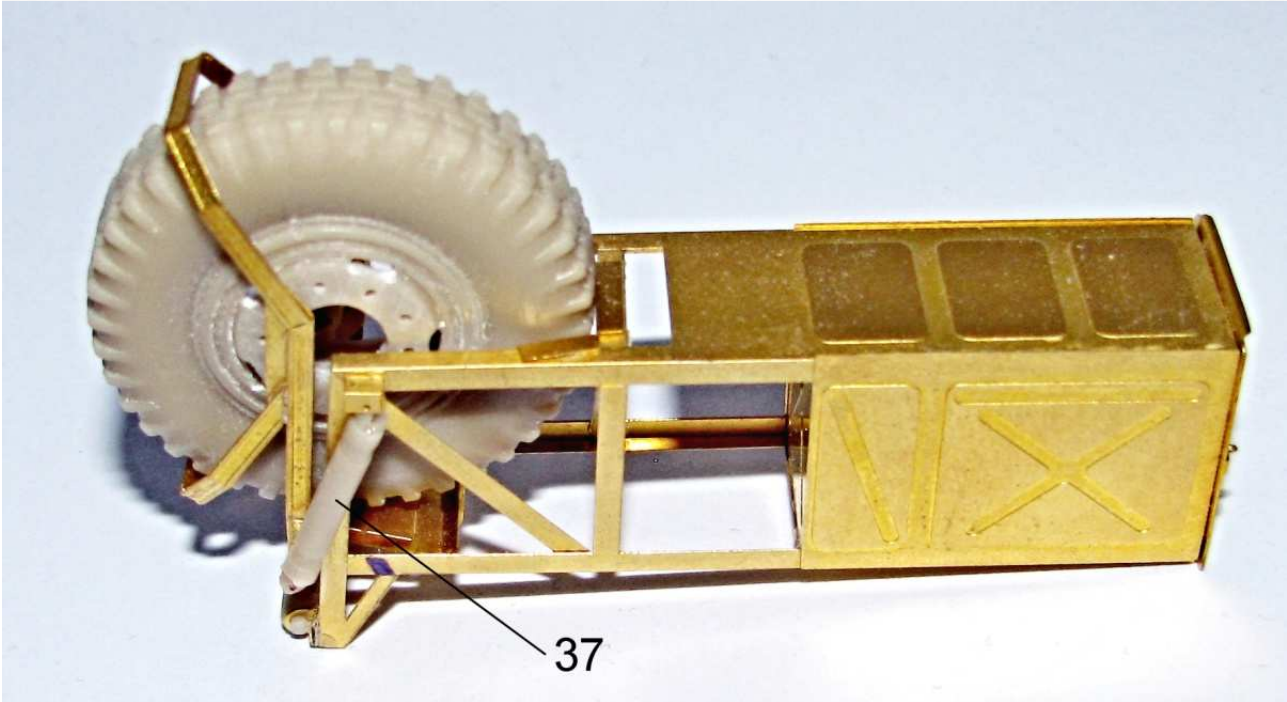
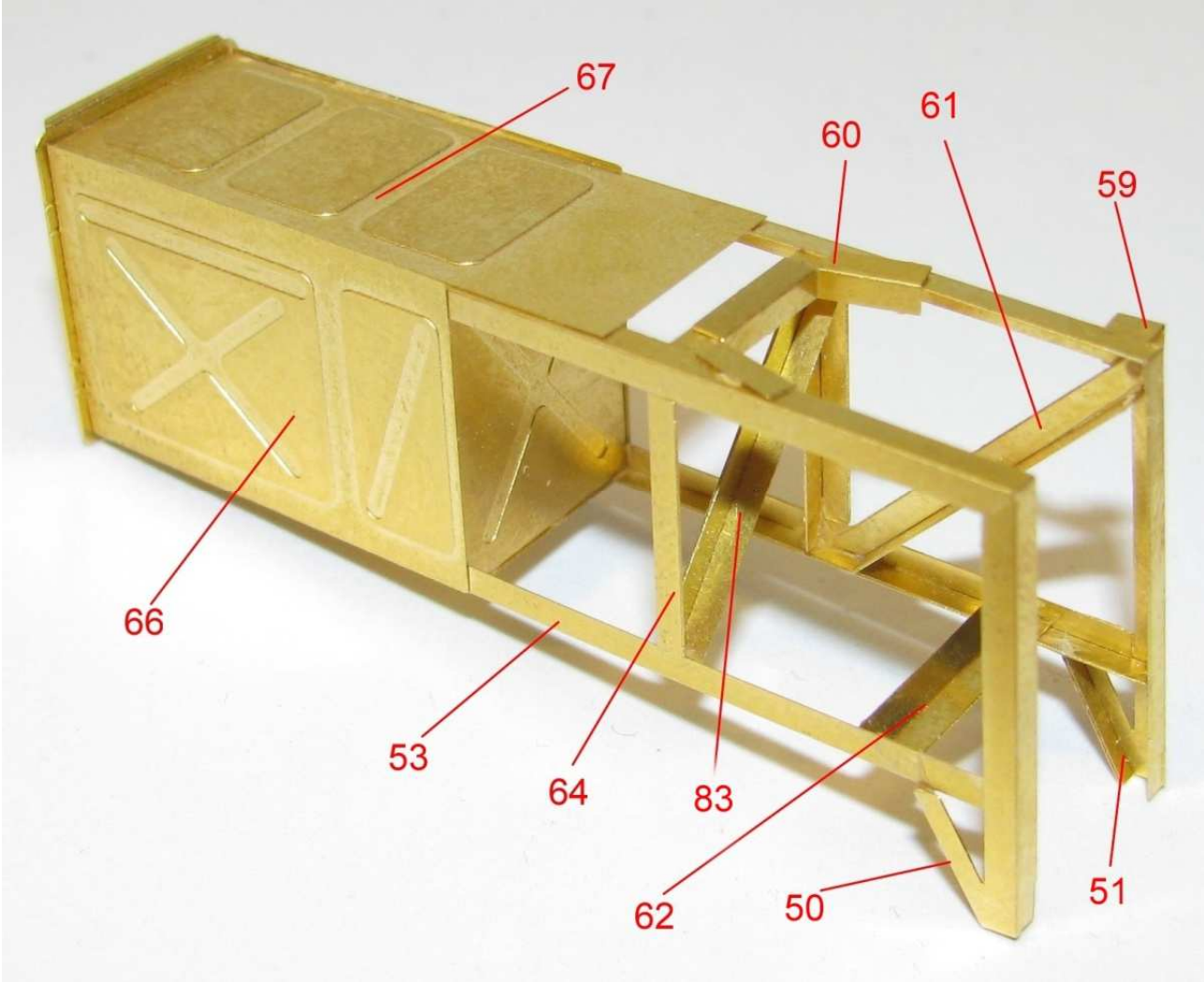

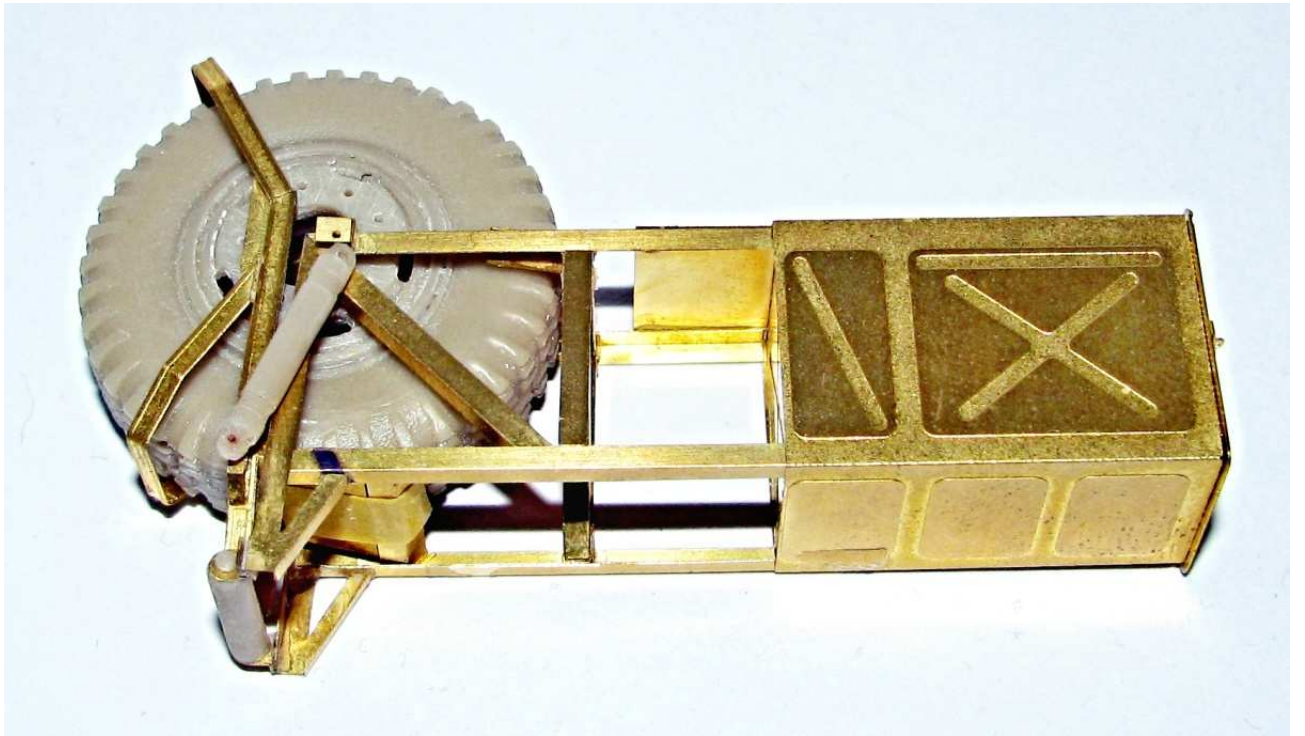

(K)

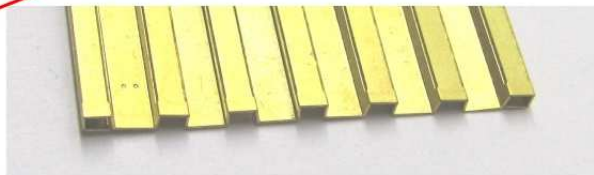
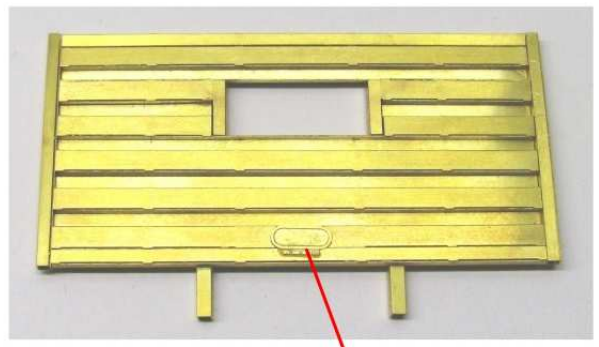
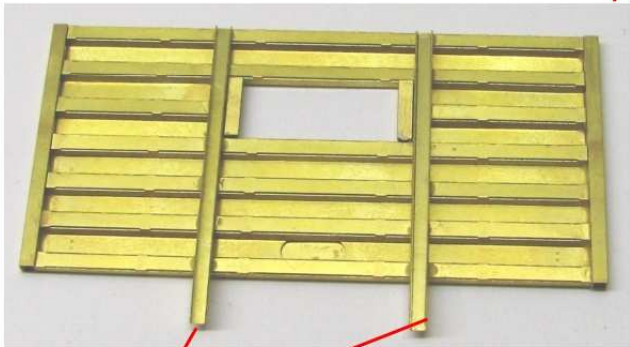
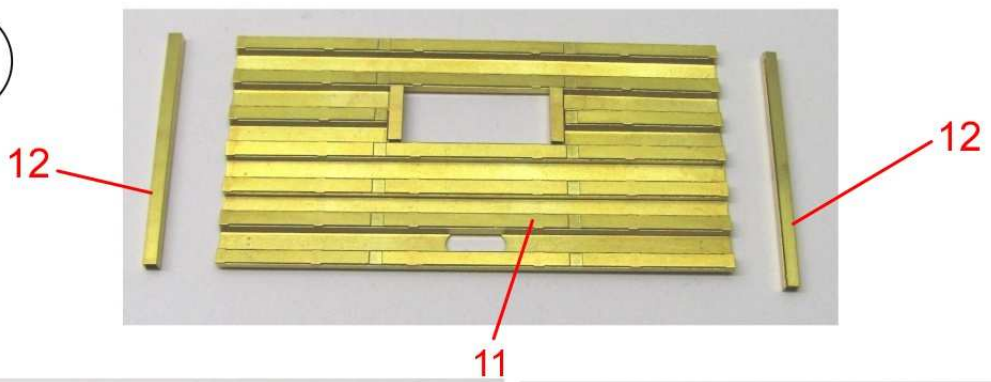

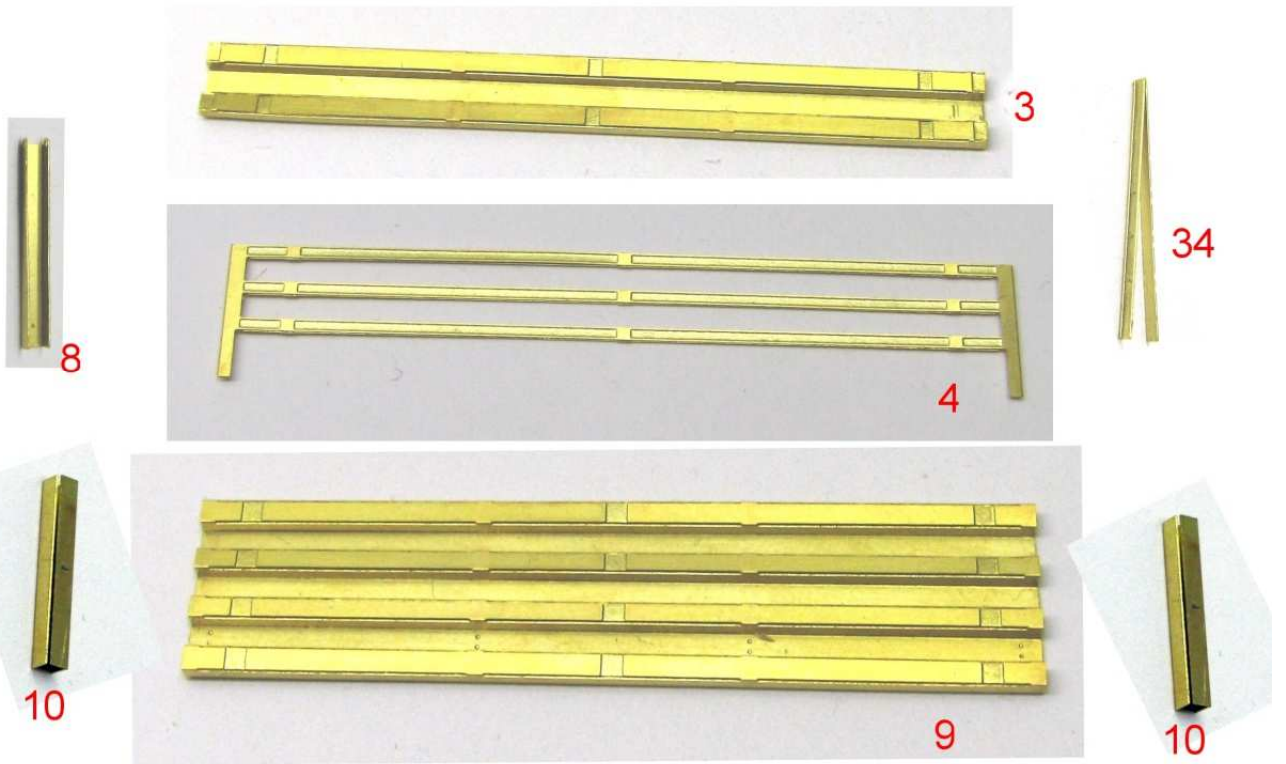
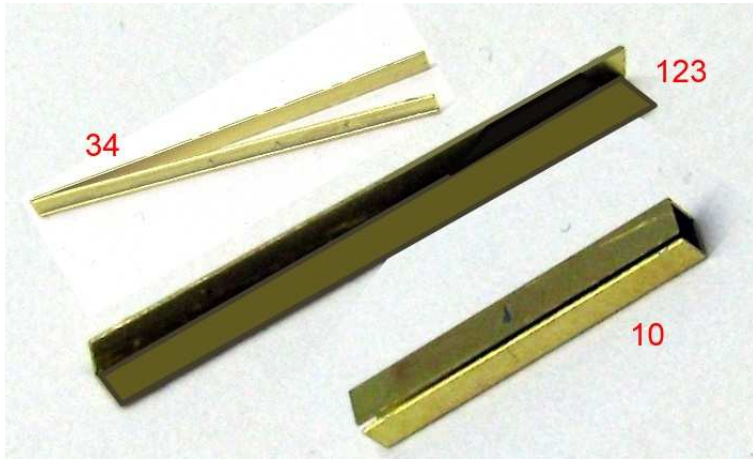

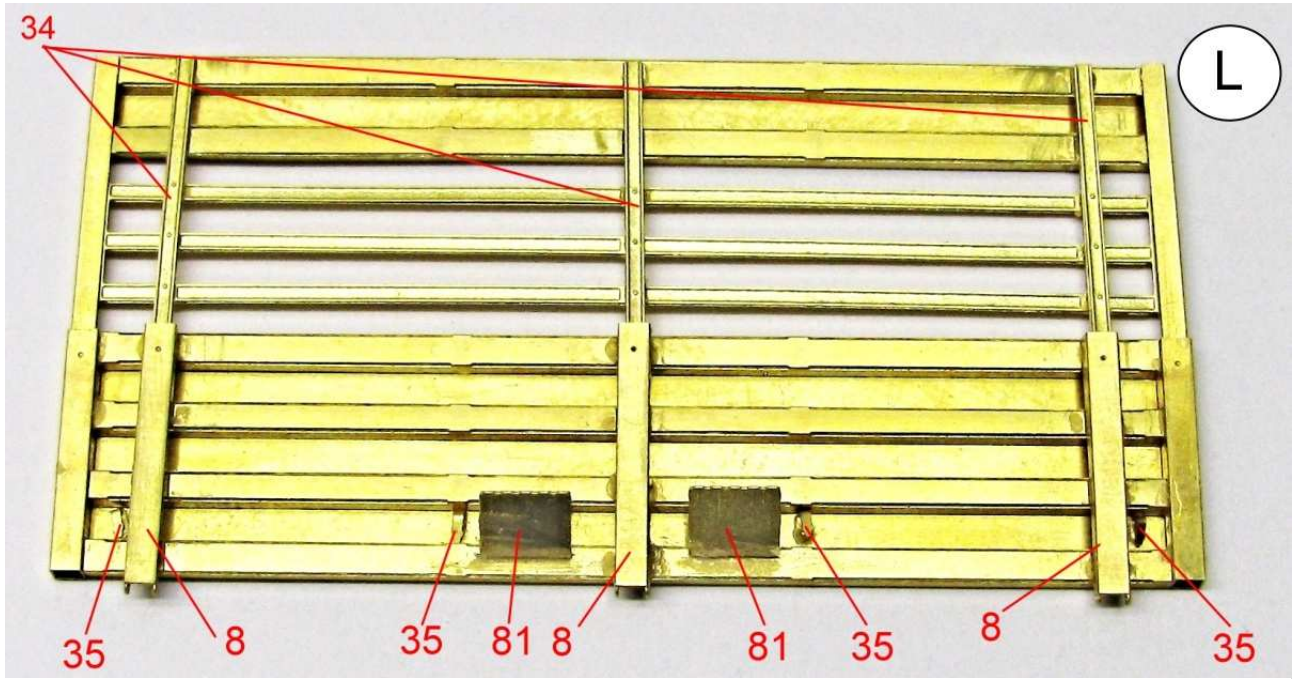

M L

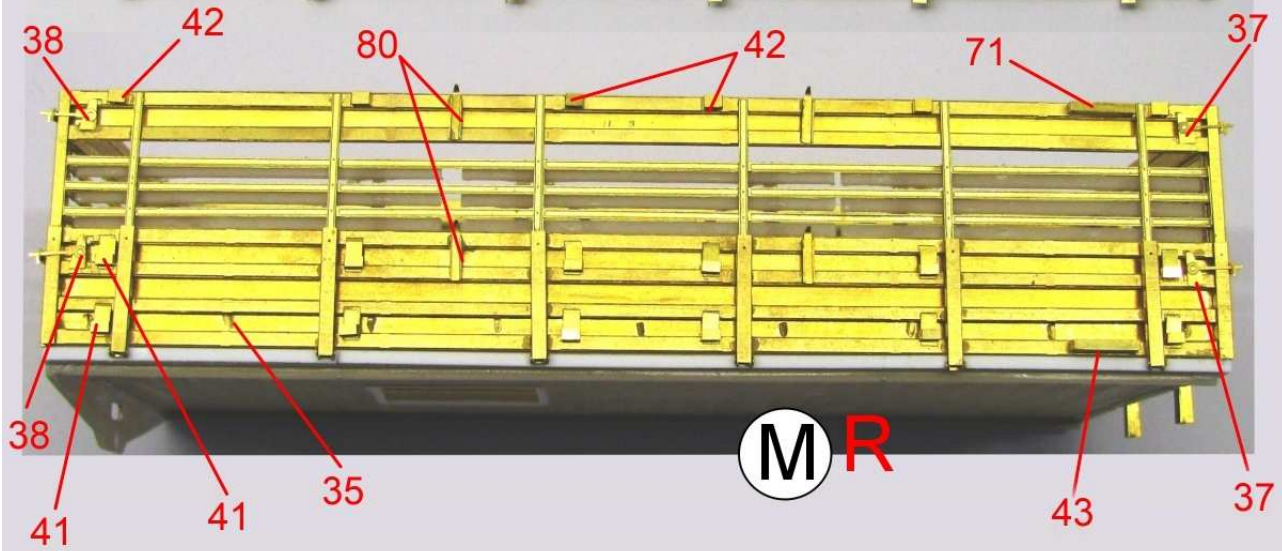
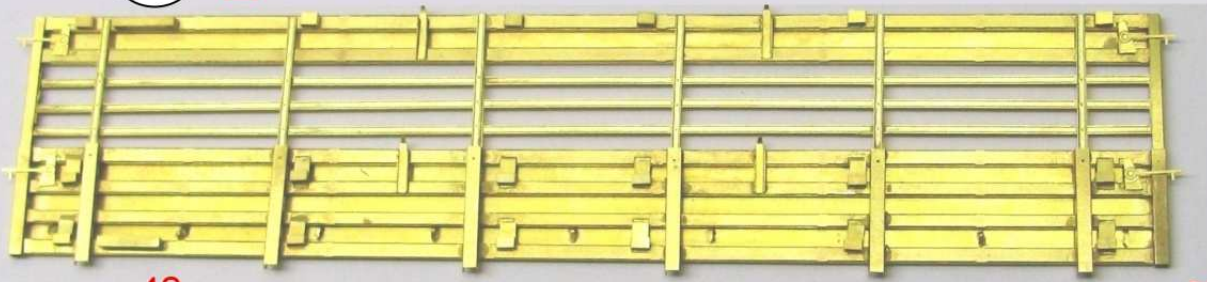

M R

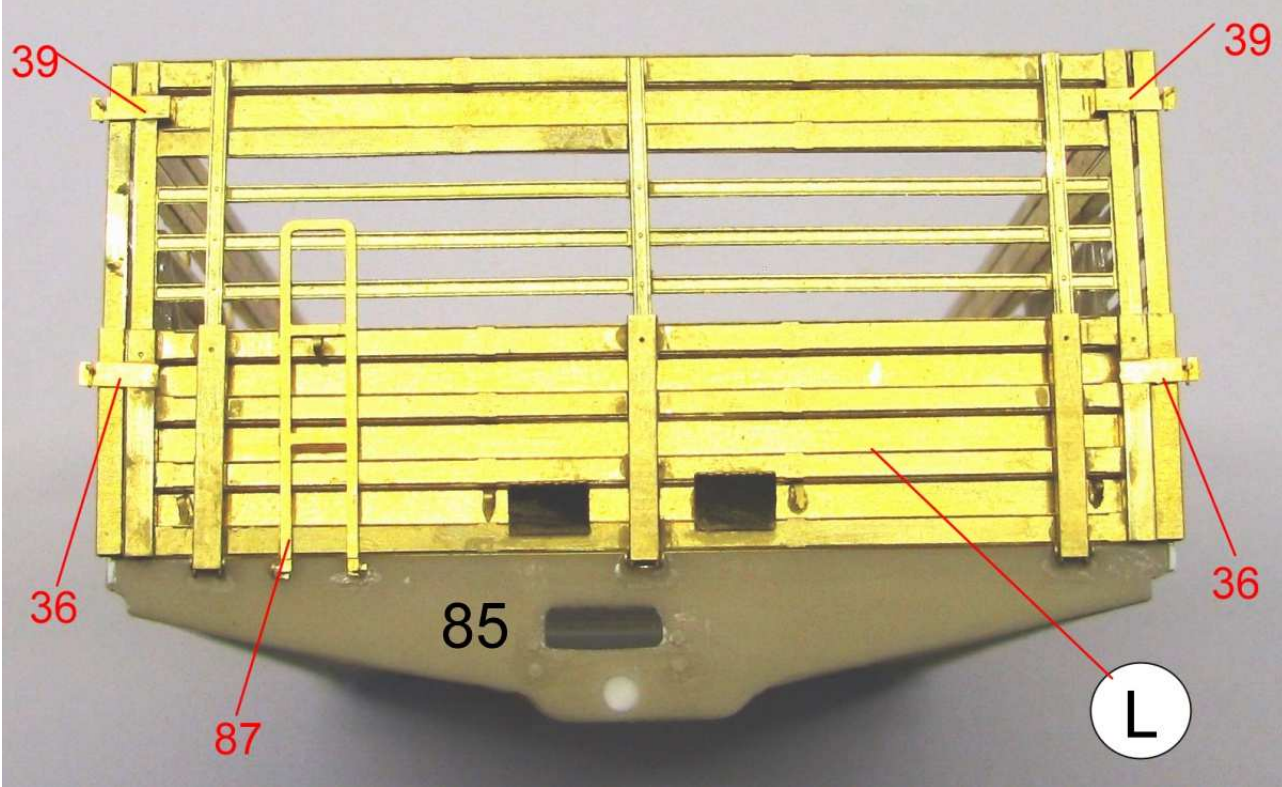

L

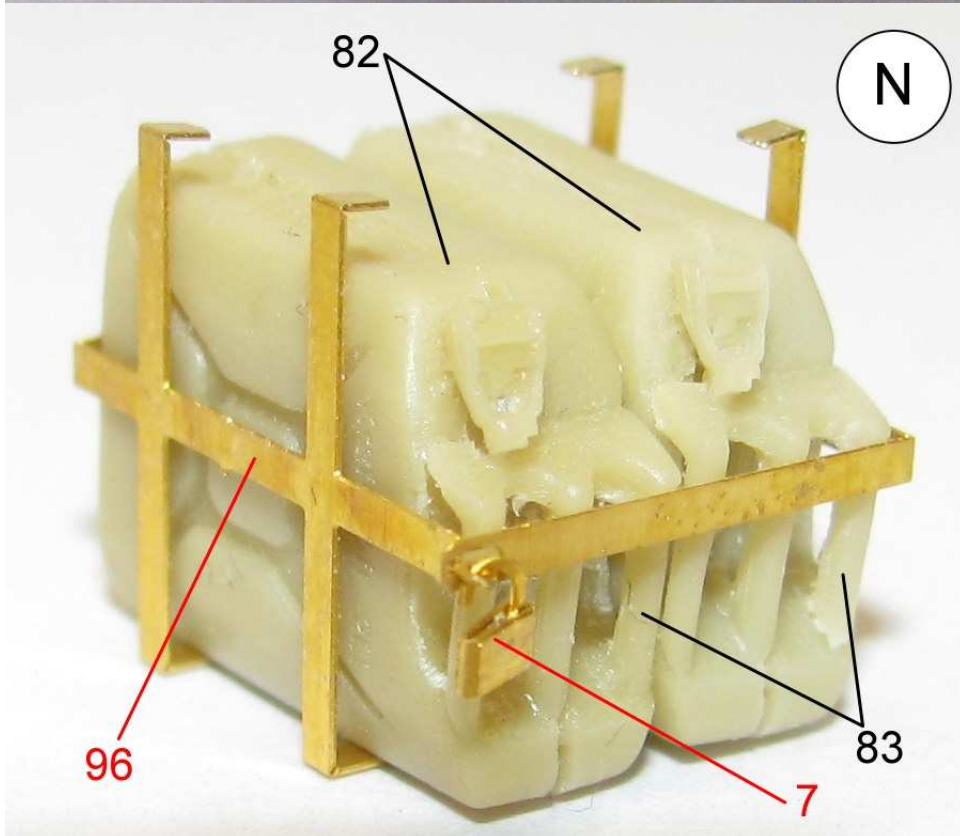
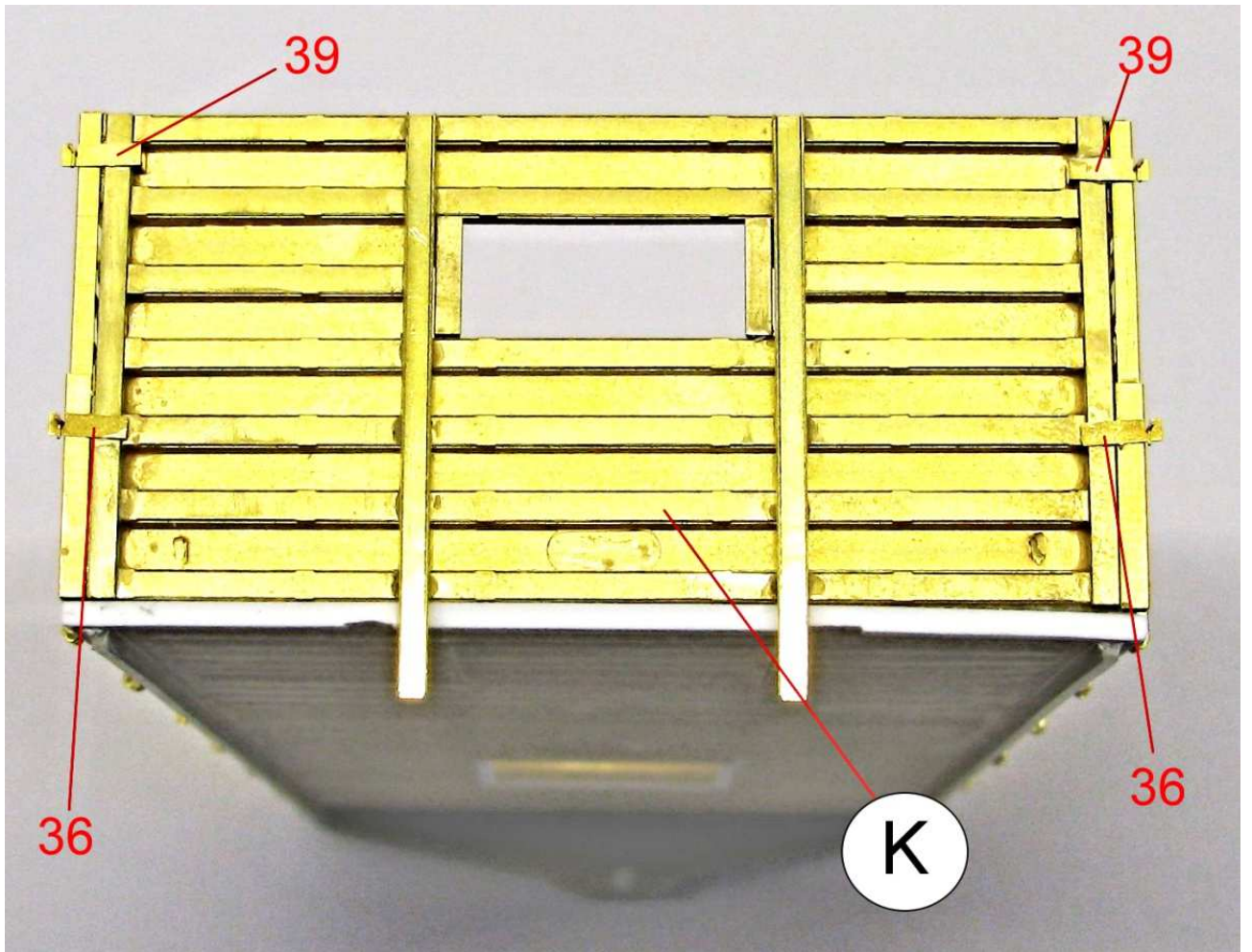

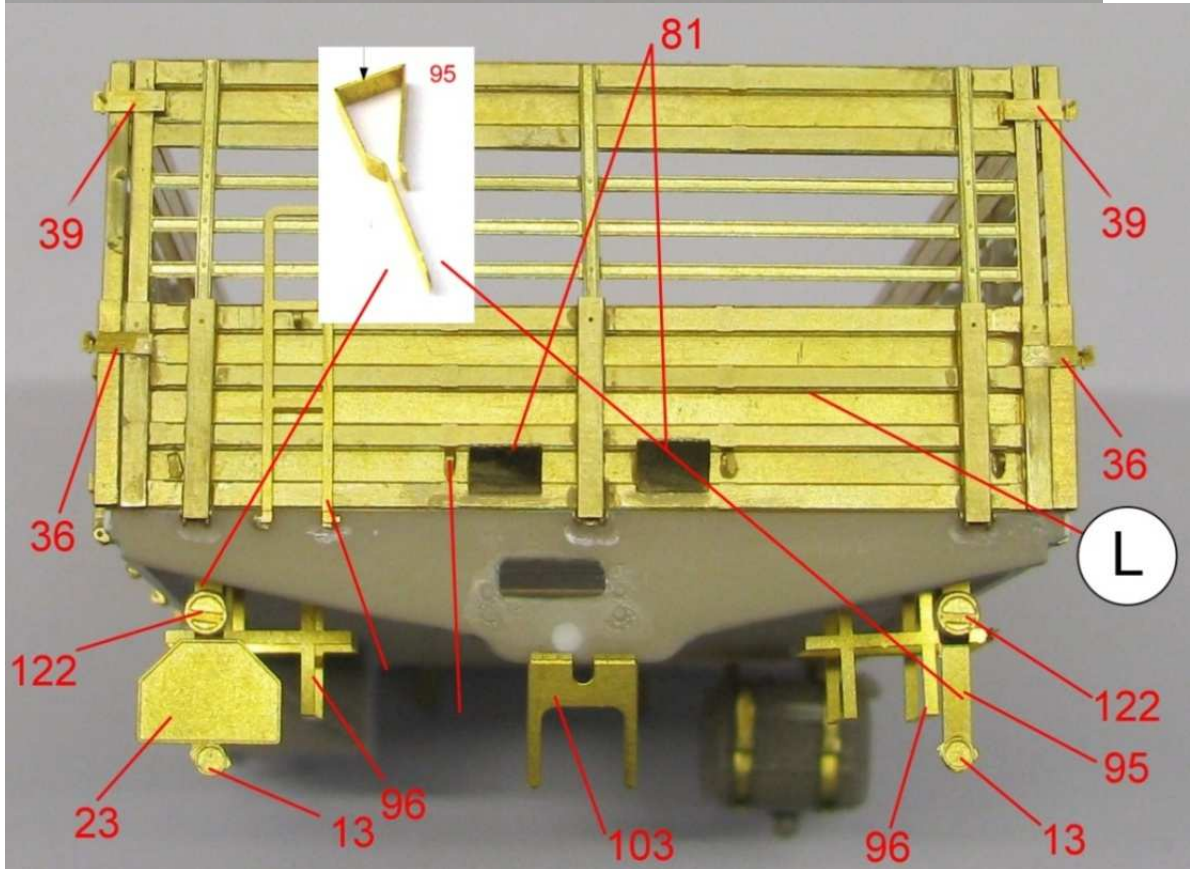
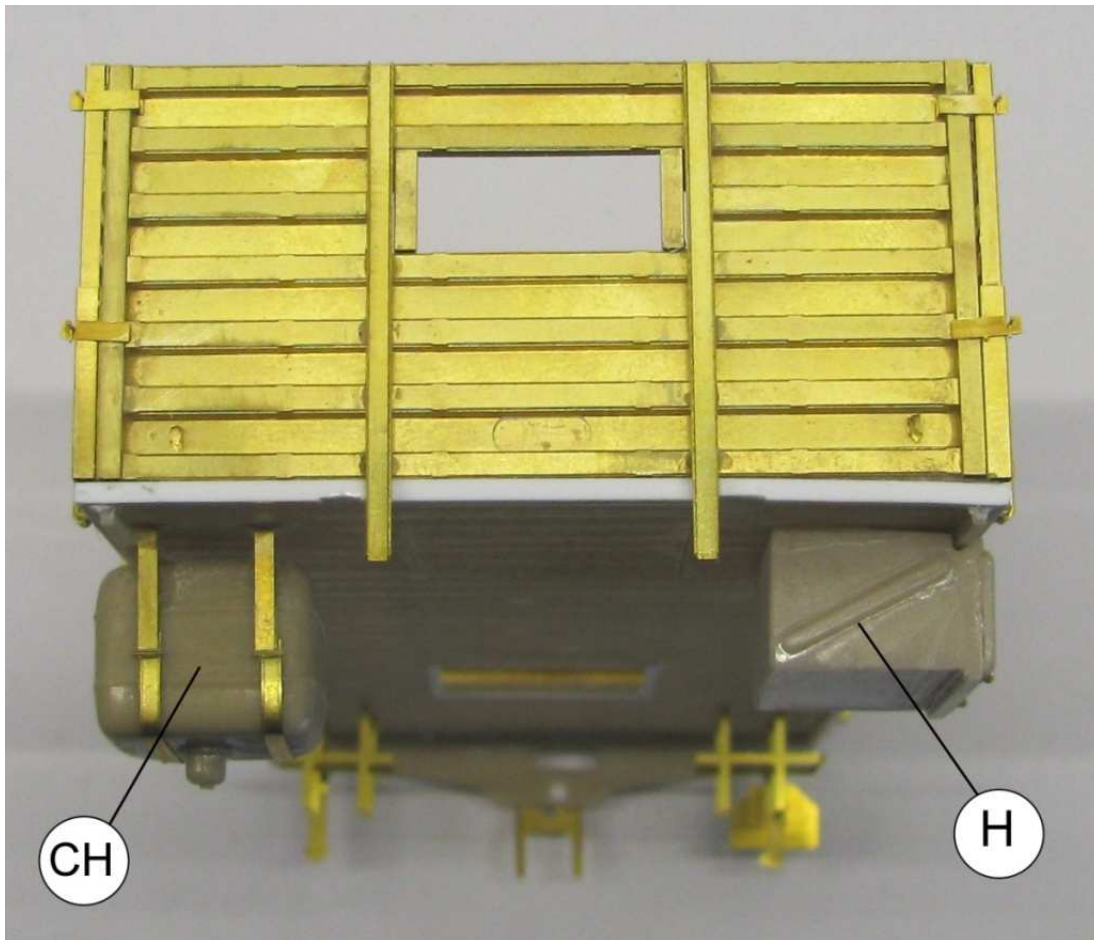



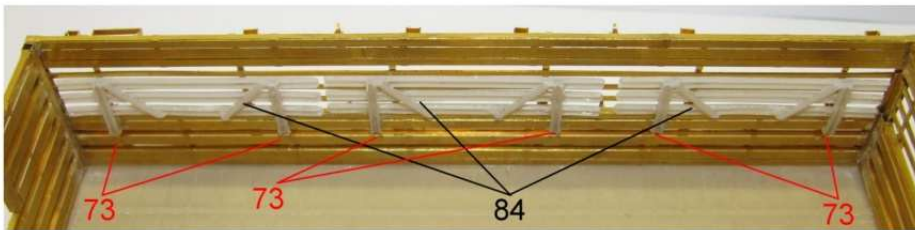
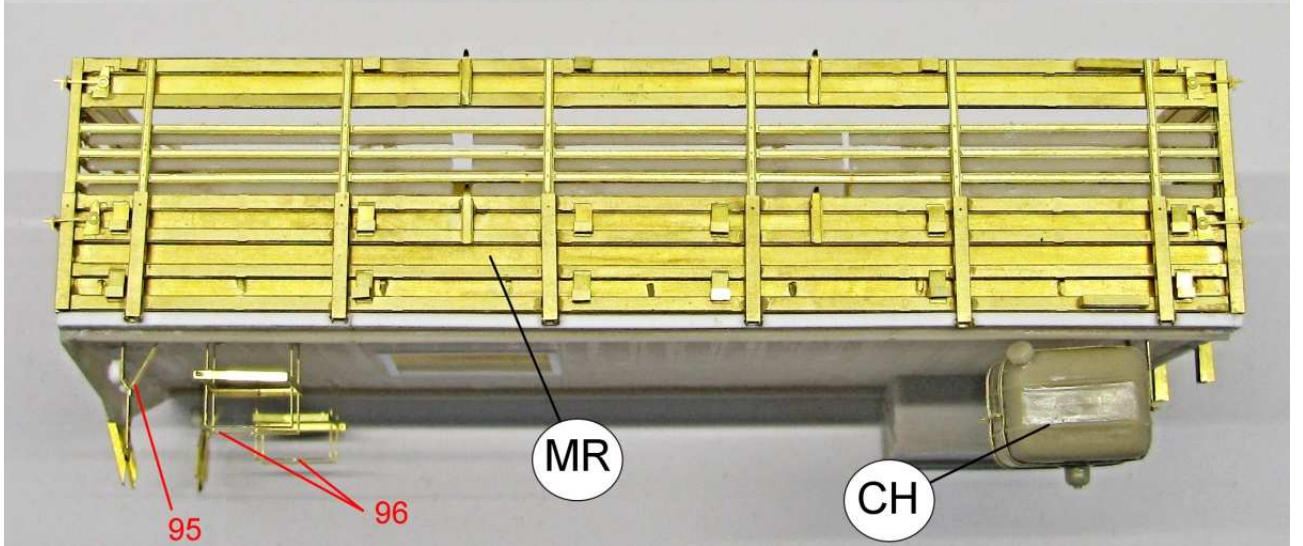
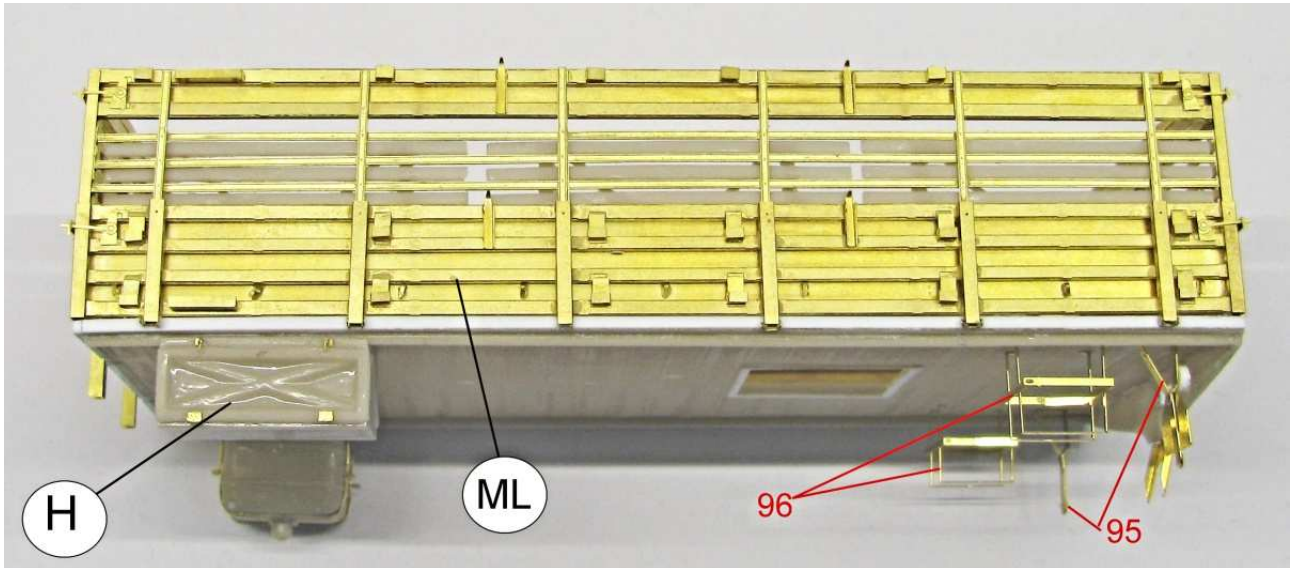

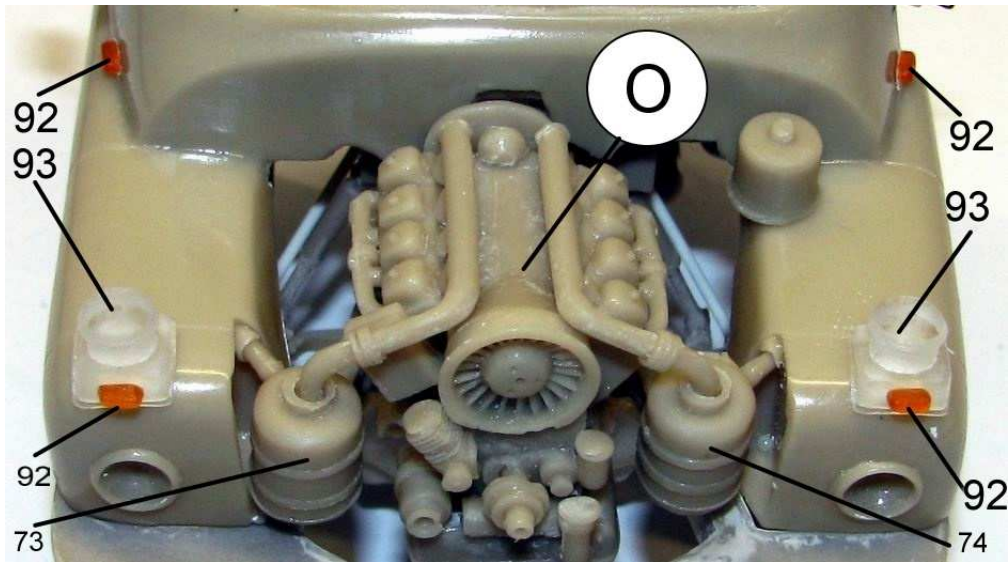
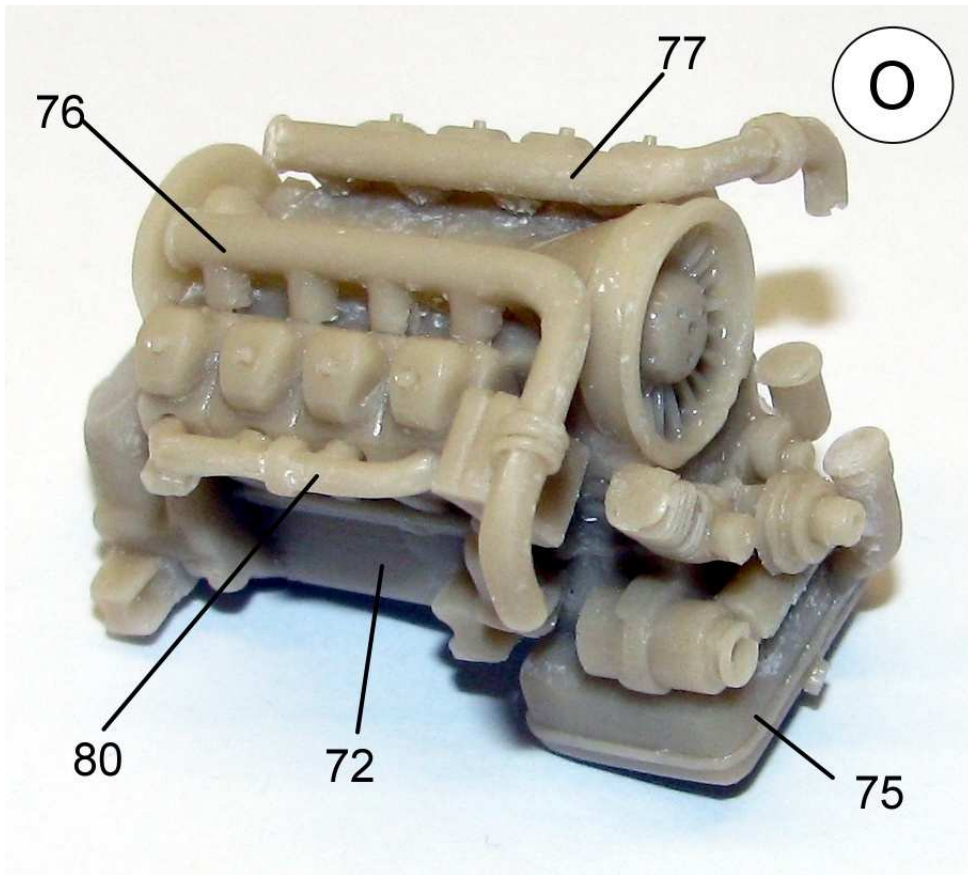

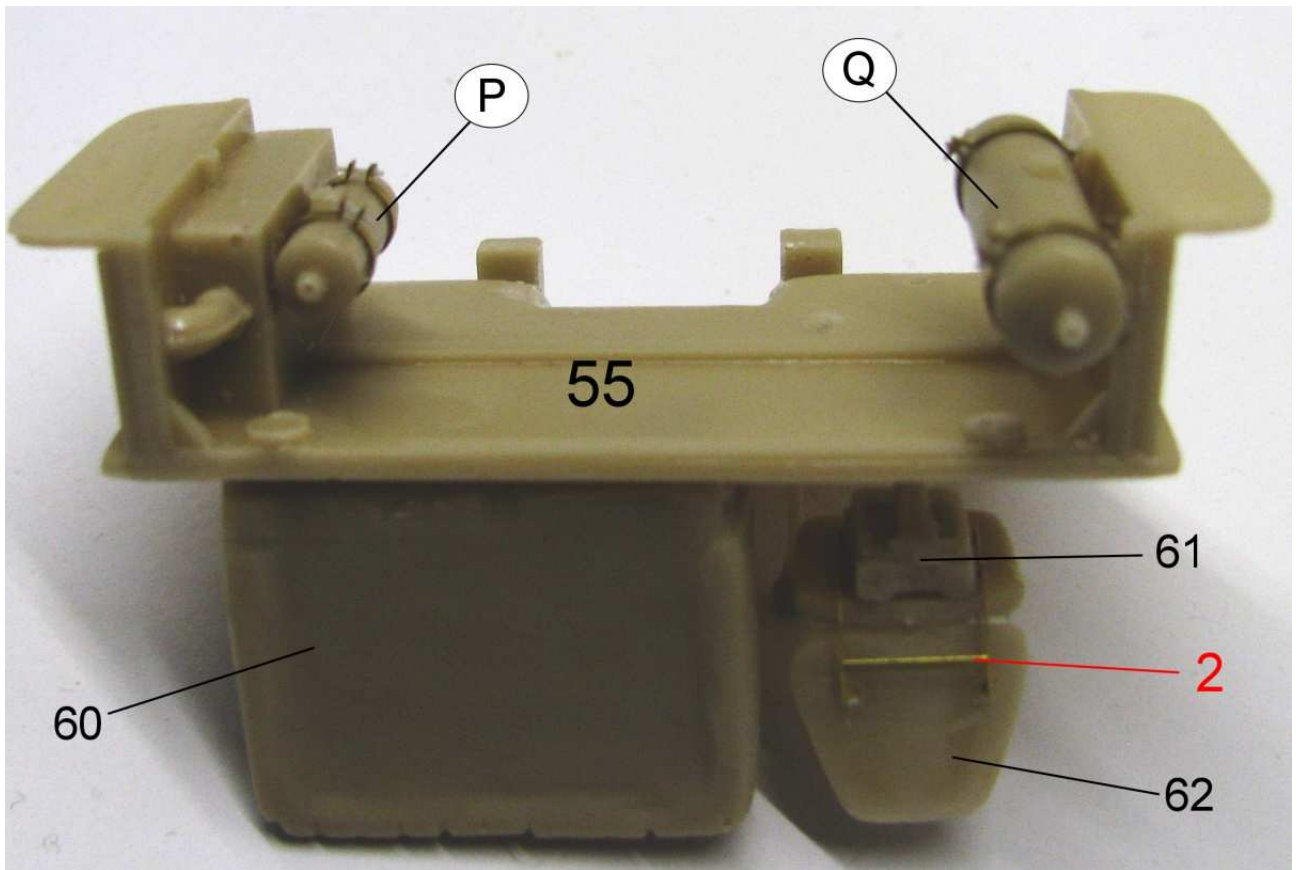
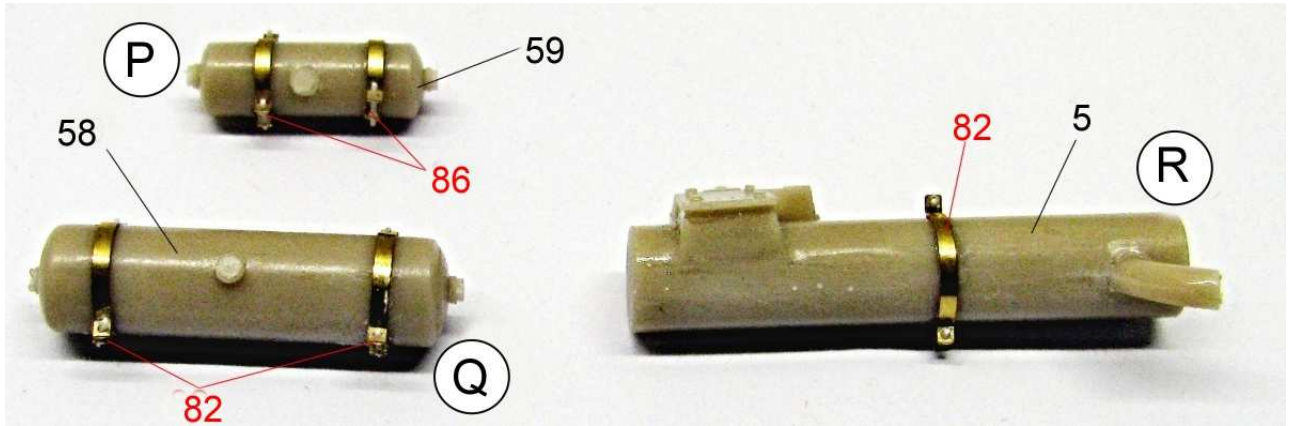

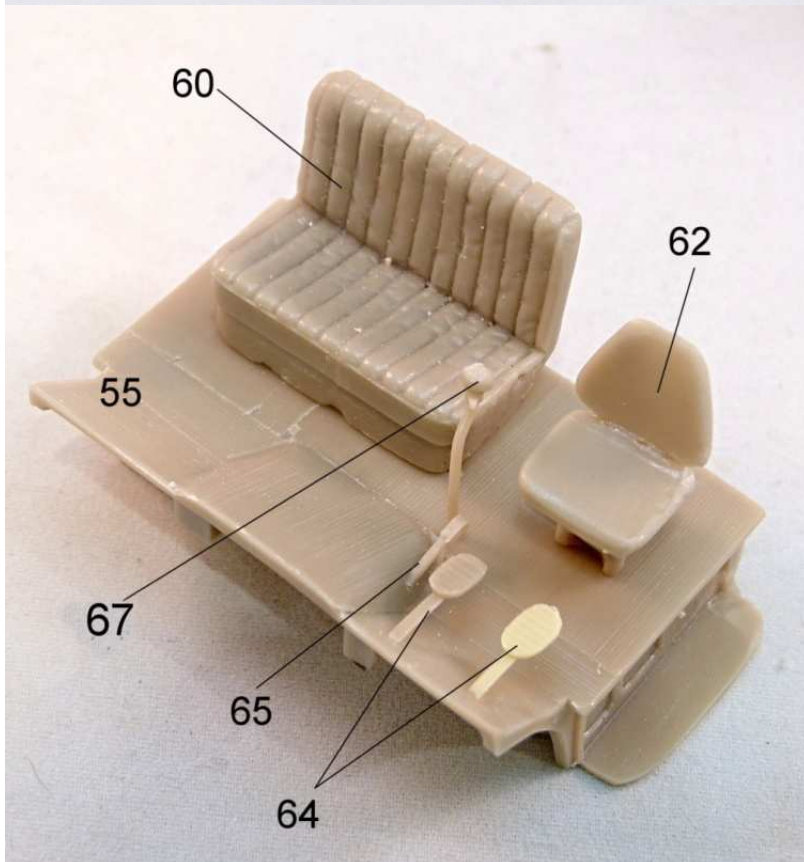
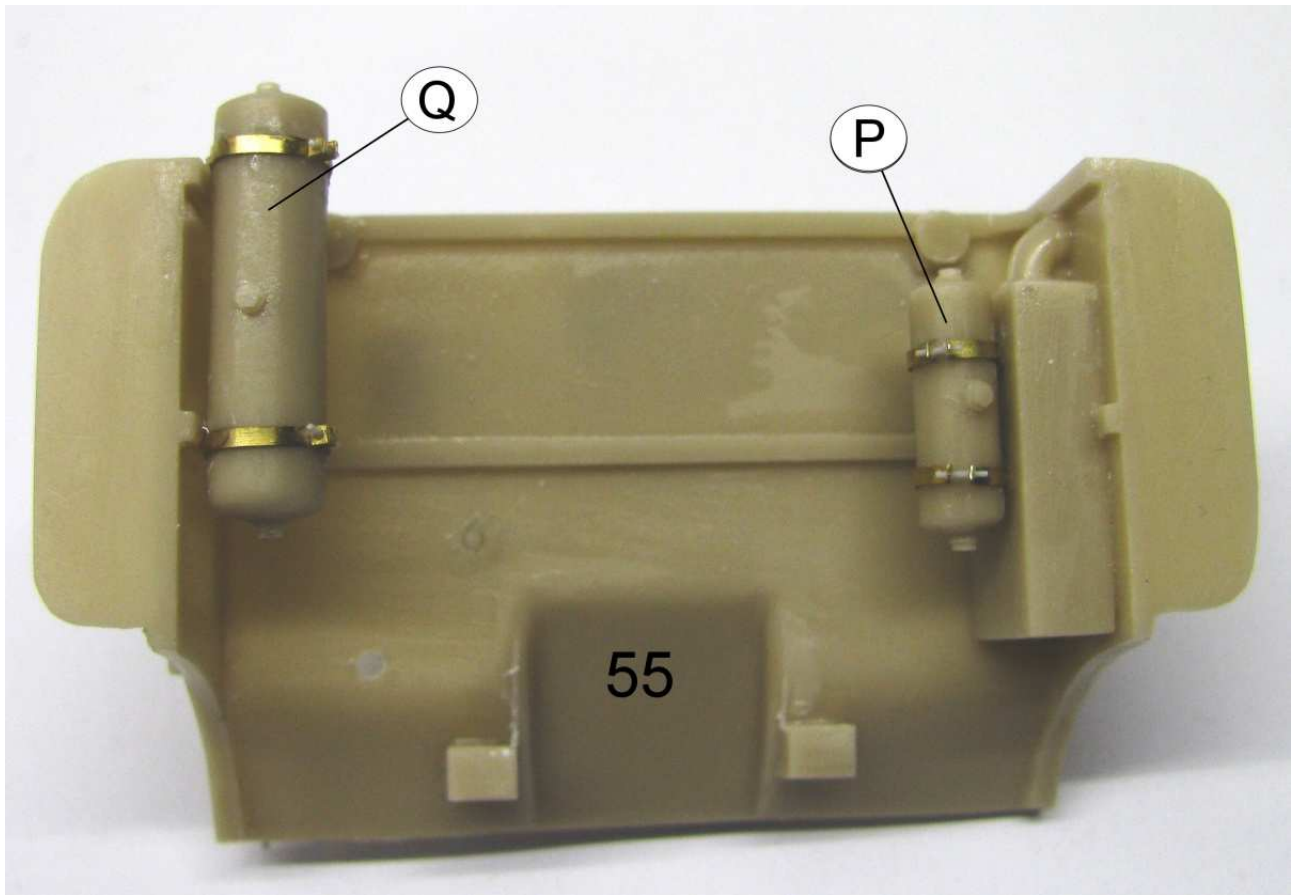

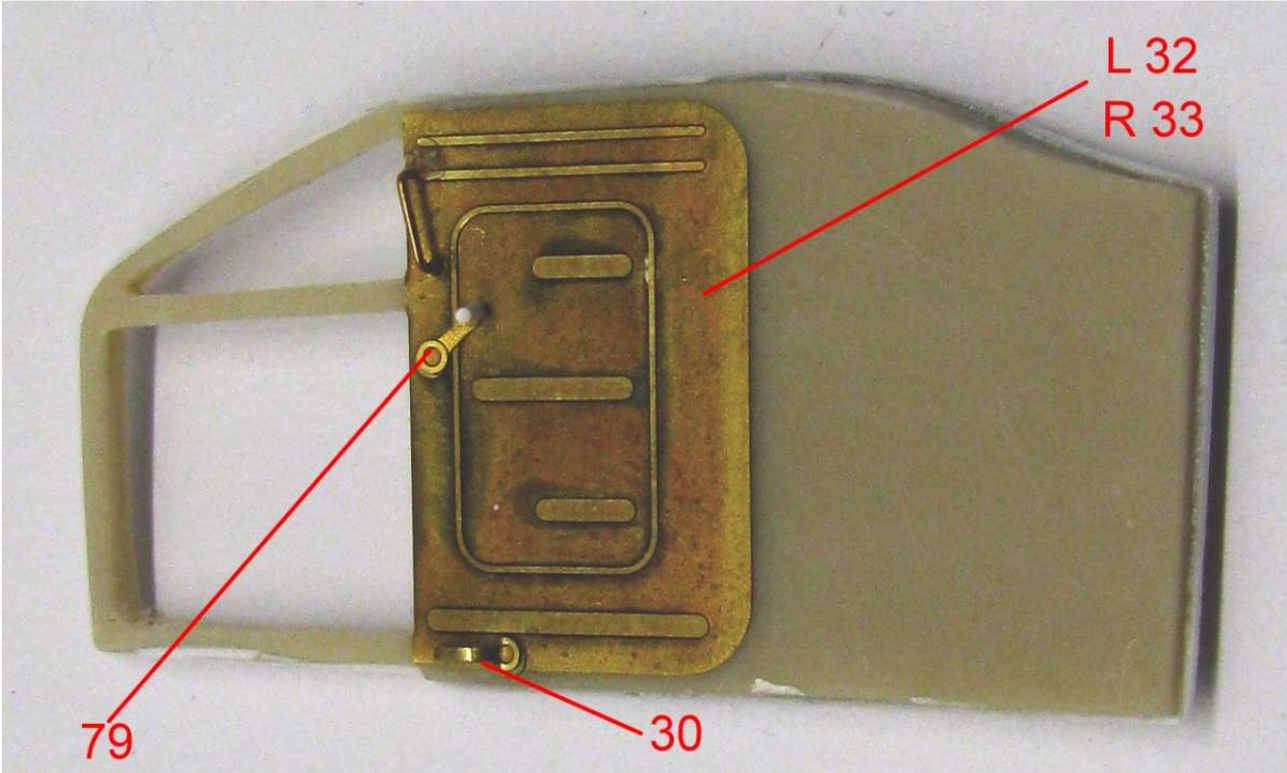
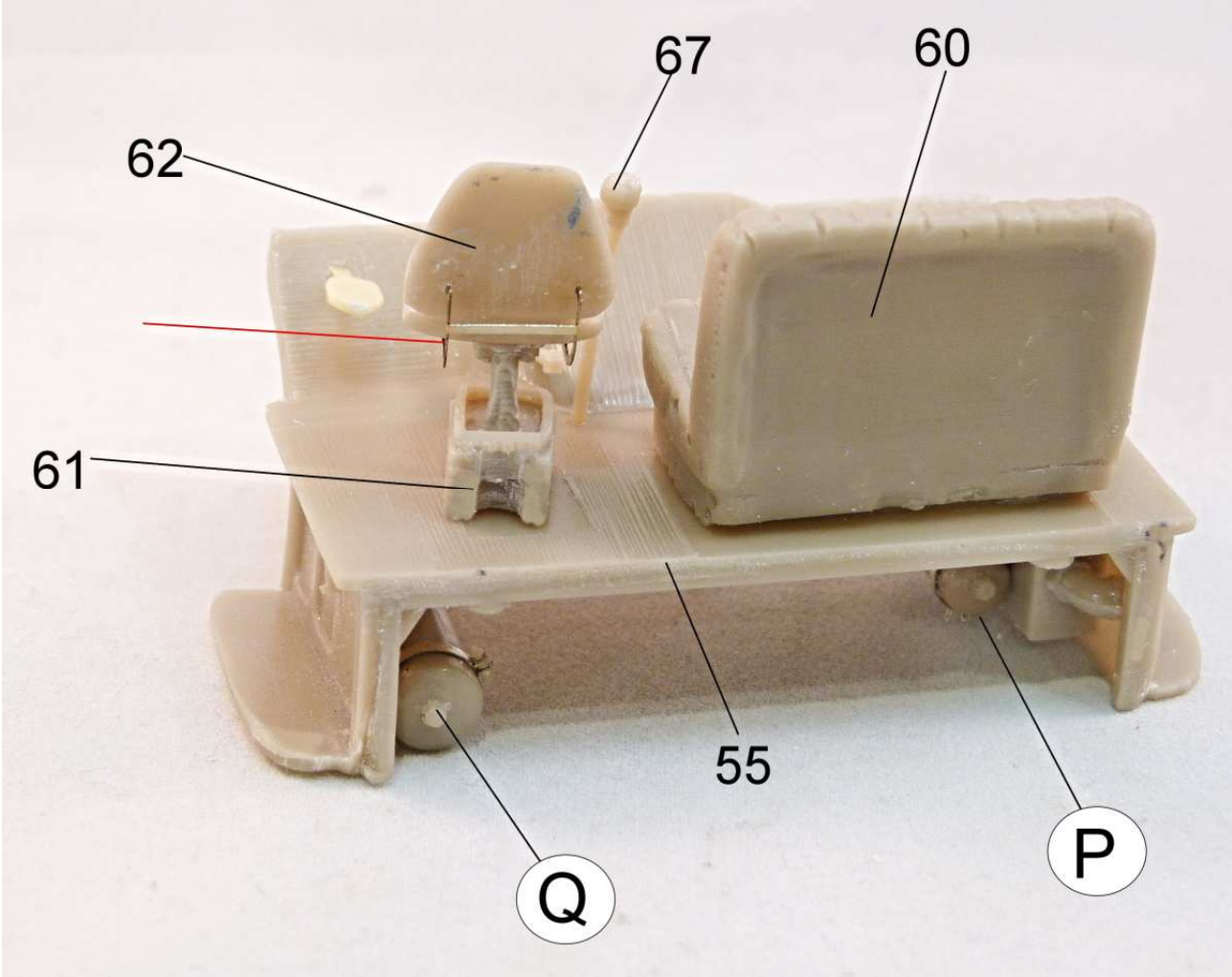

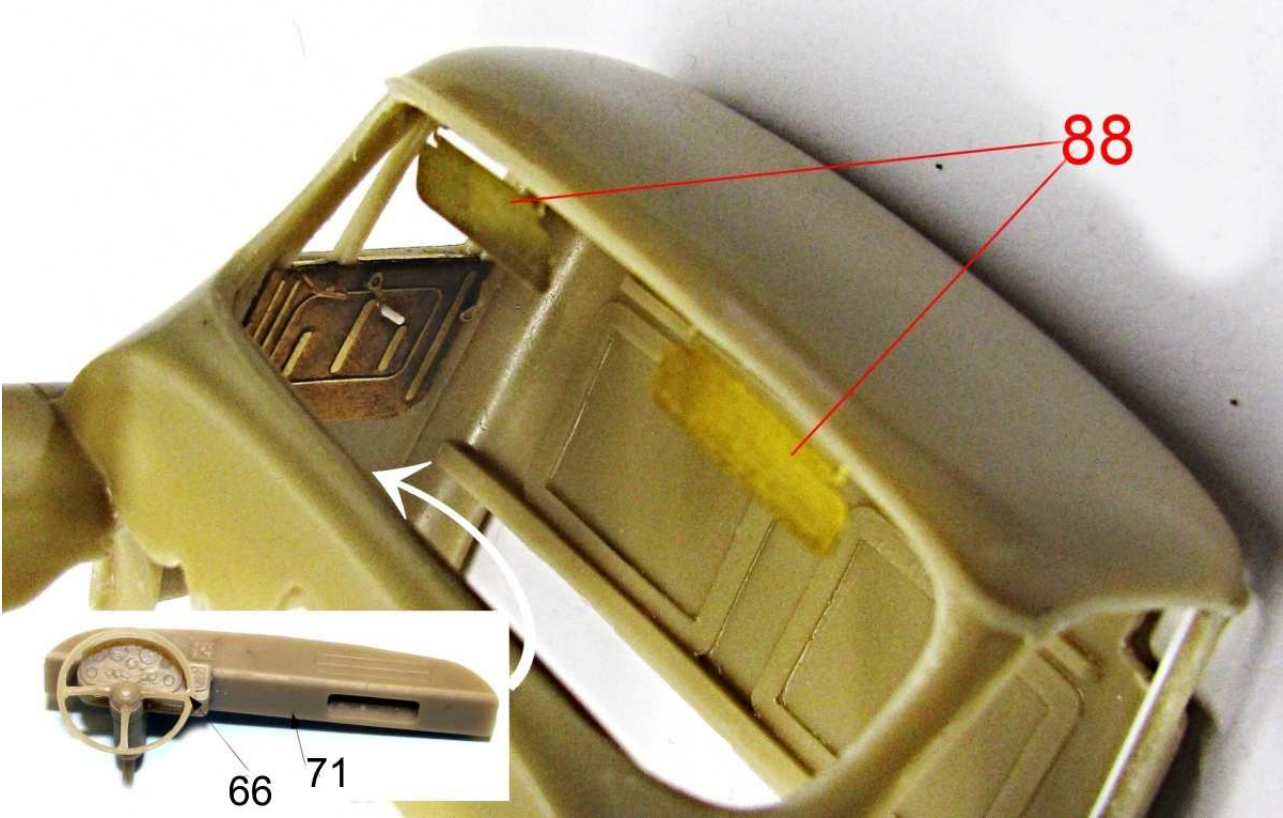

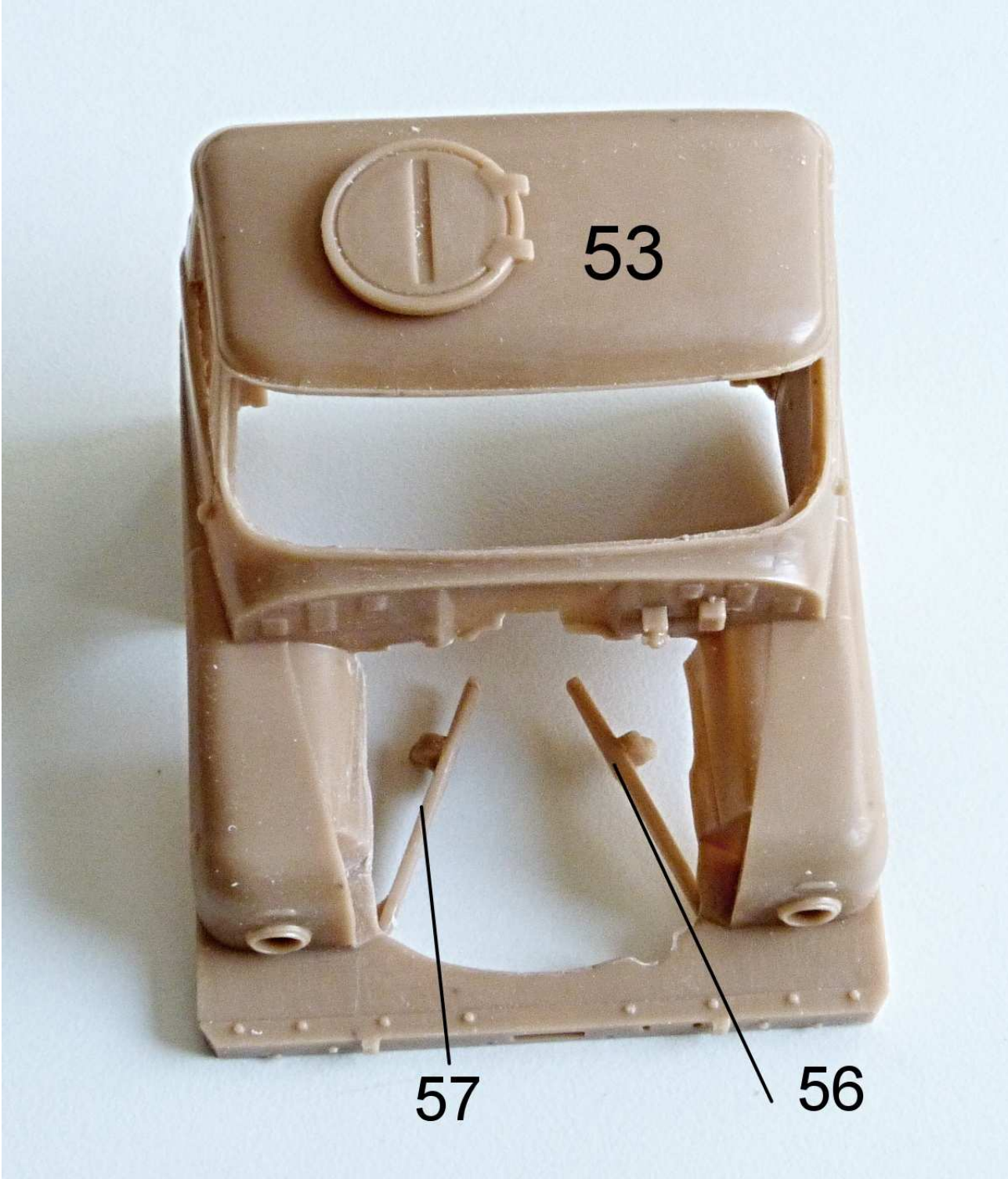





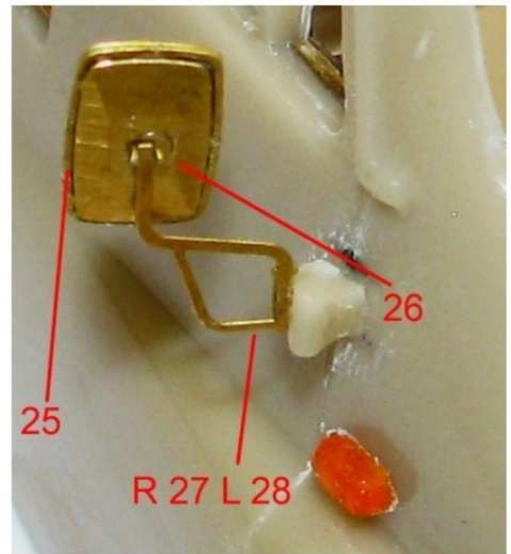
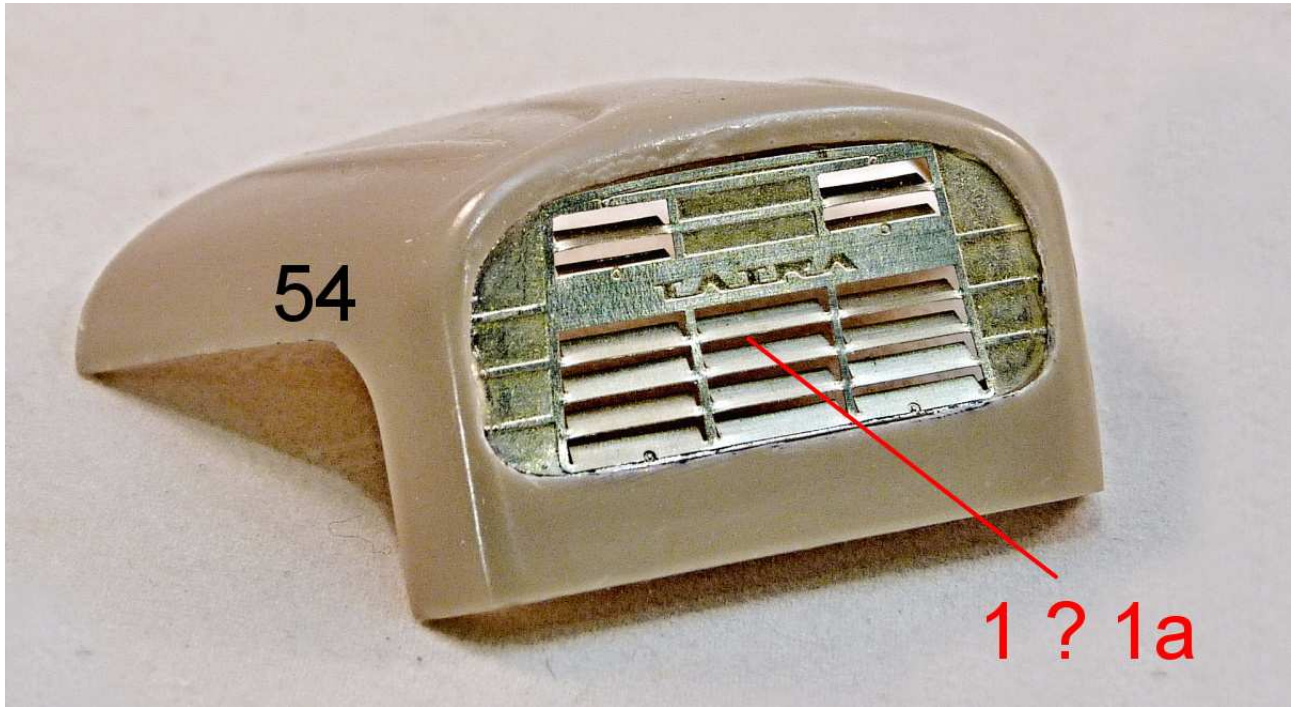

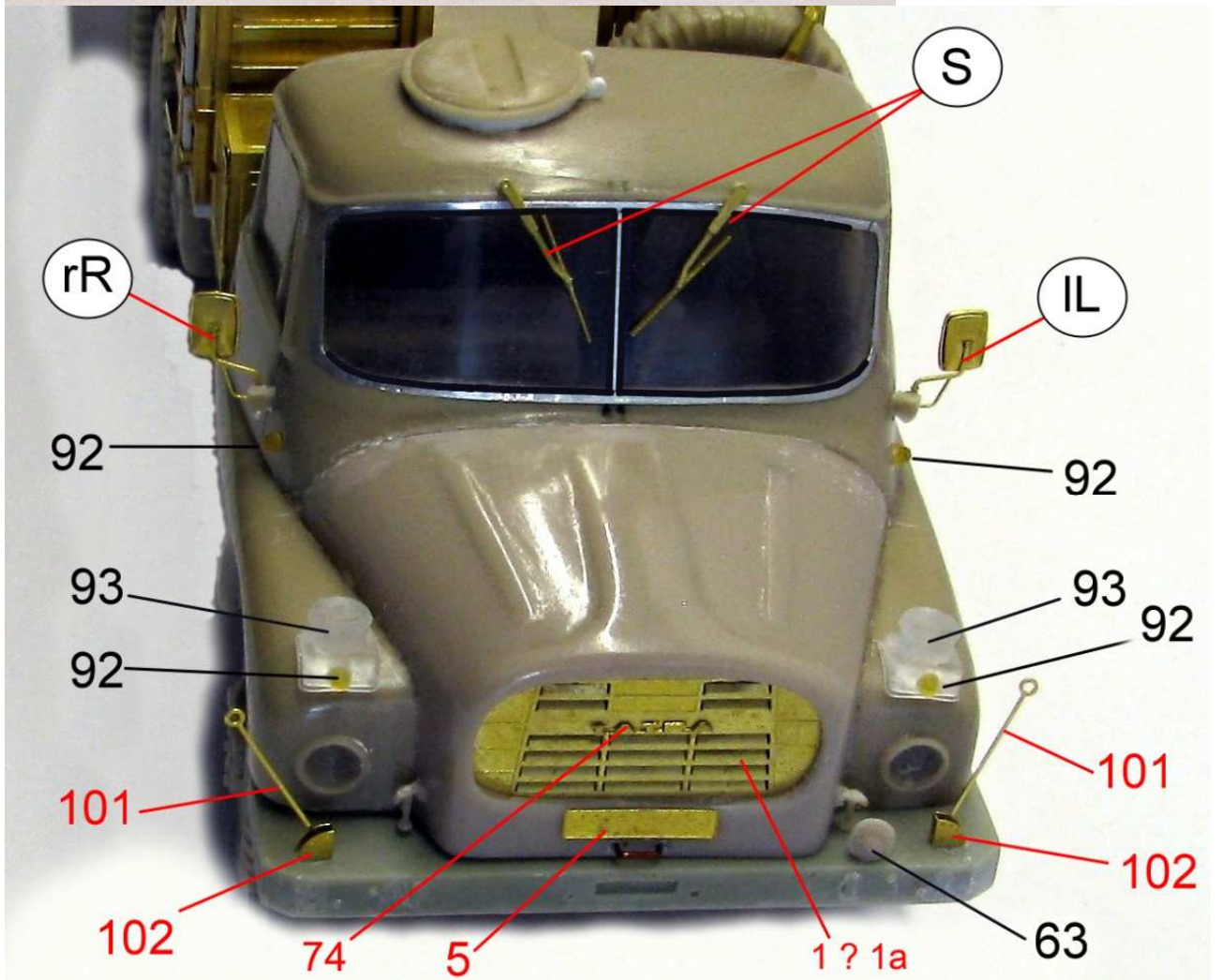
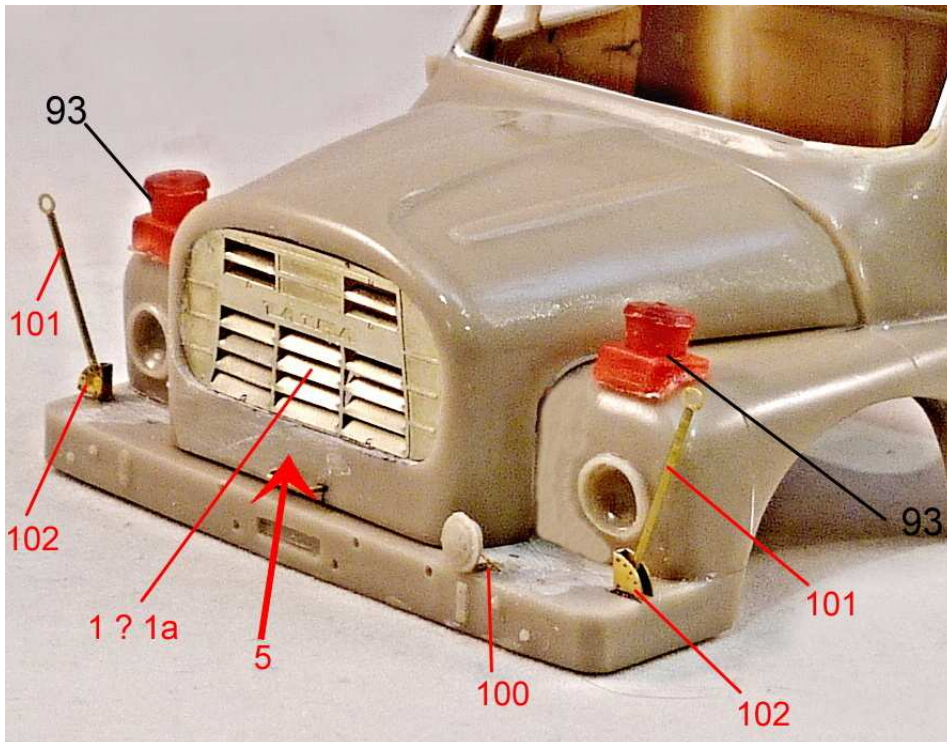

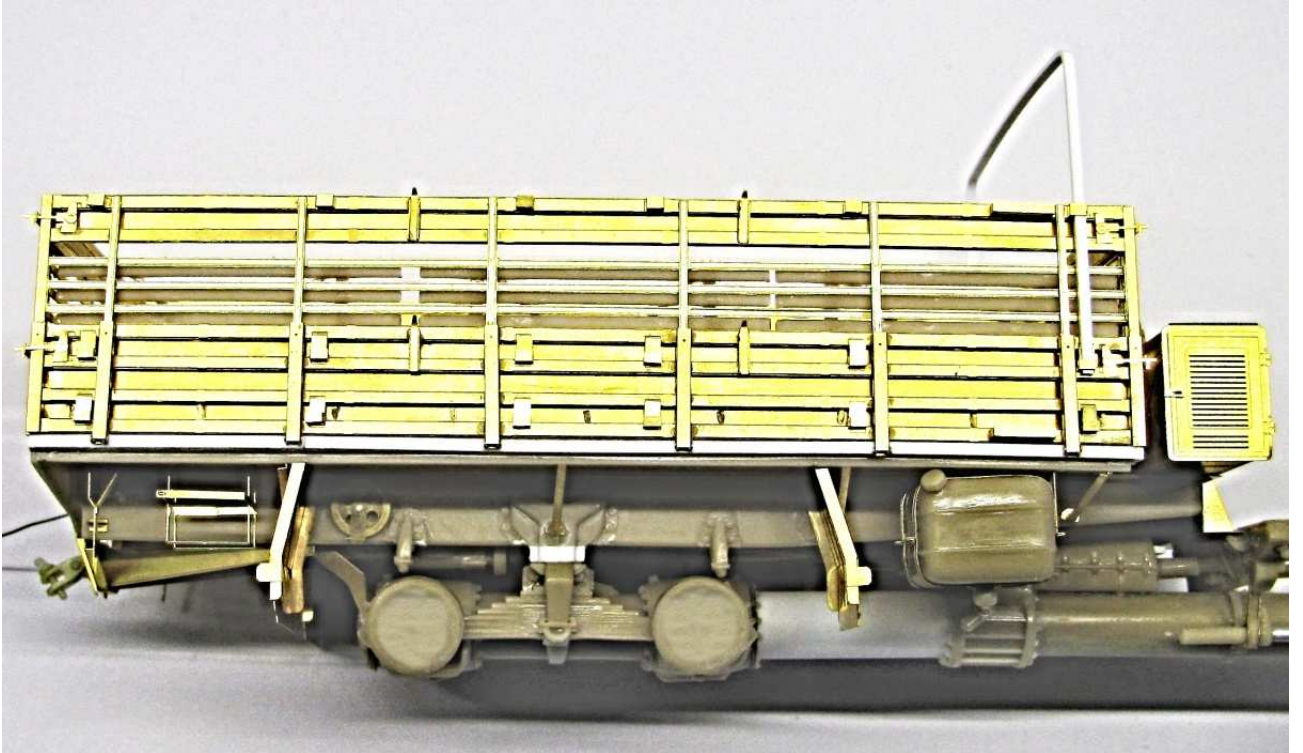

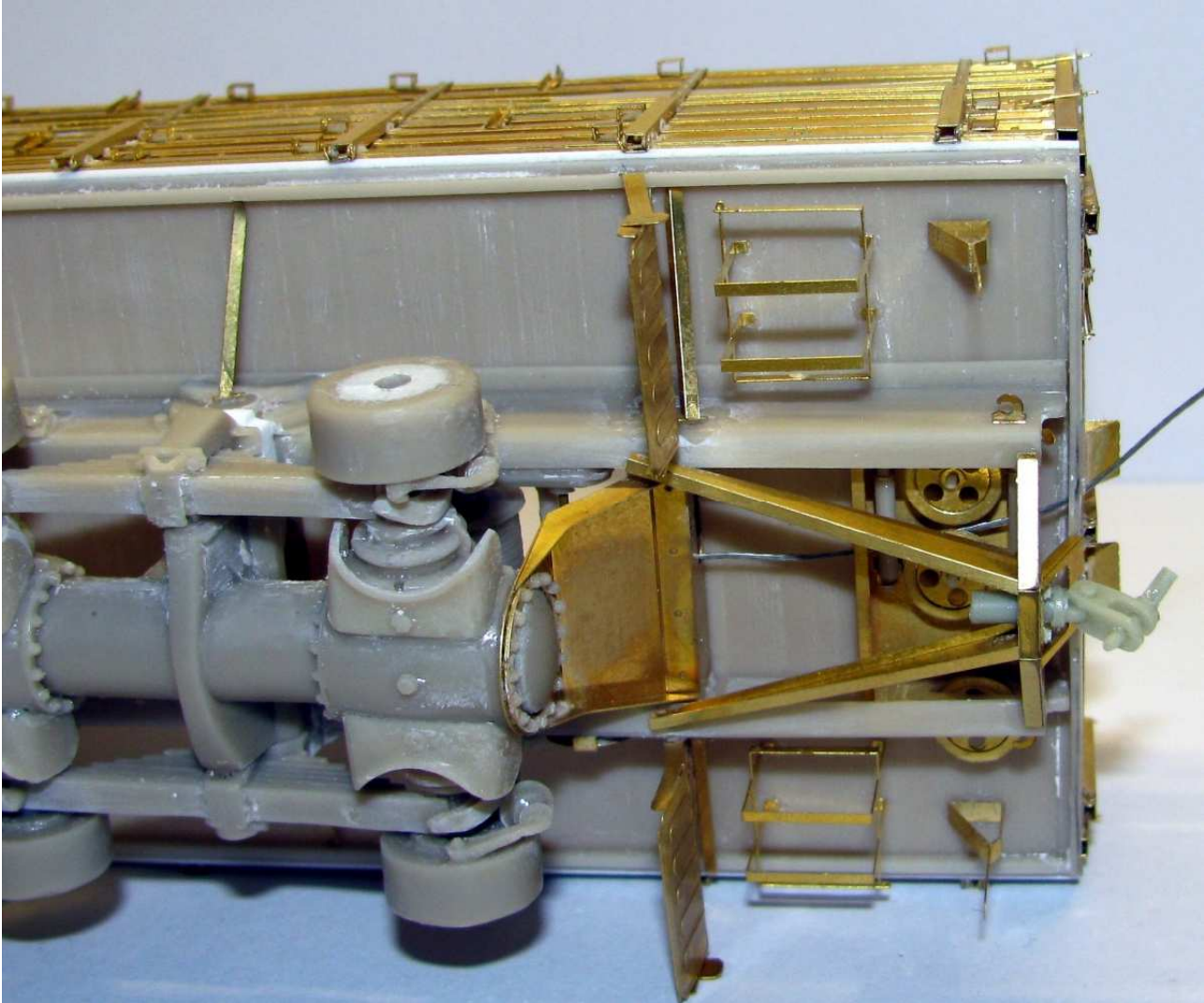

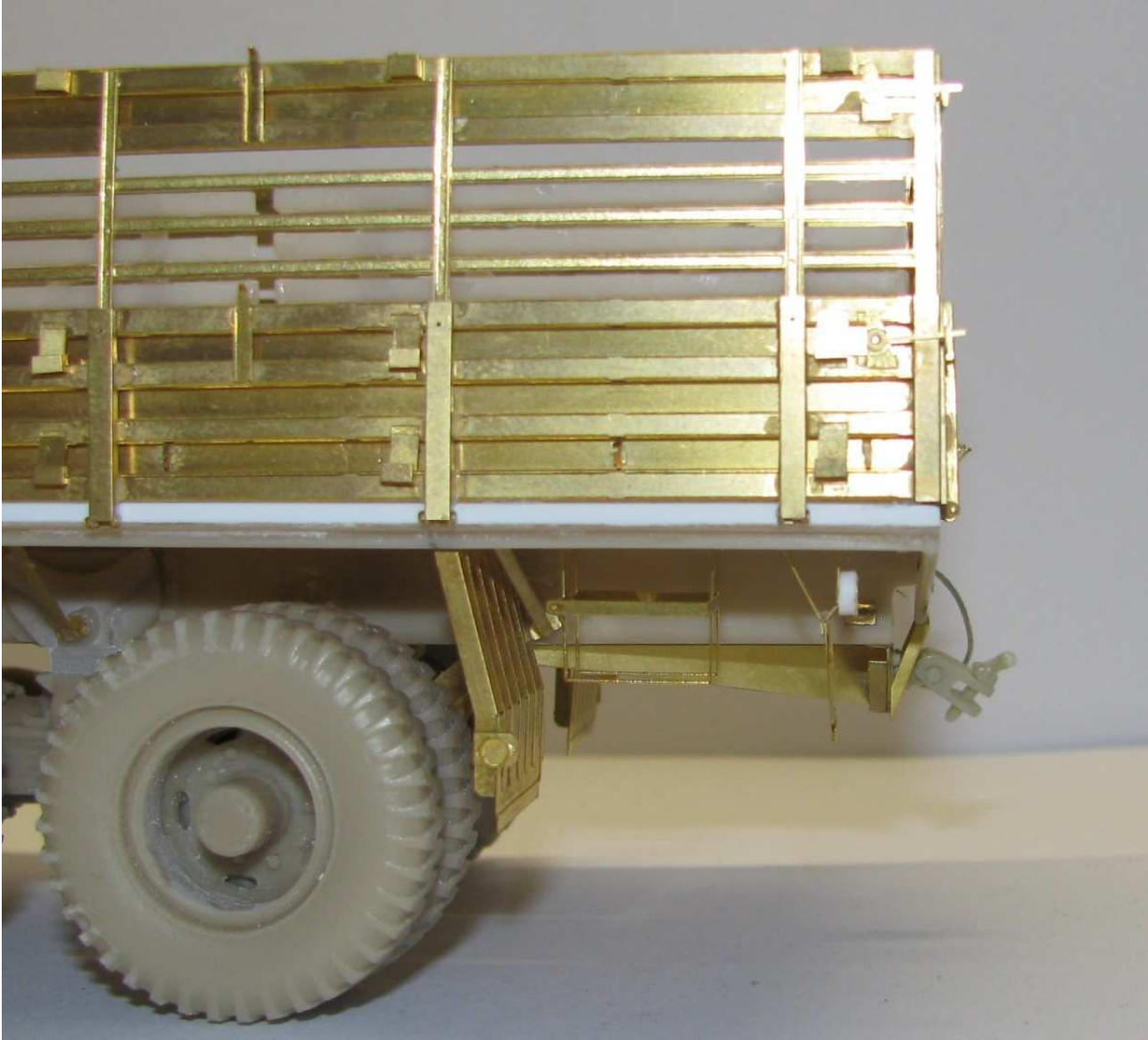











MMK Folknáře 70 40501 Děčín [www.mmk.cz](http://www.mmk.cz) [mk.model@volny.cz](mailto:mk.model@volny.cz)

**A 16.12A**



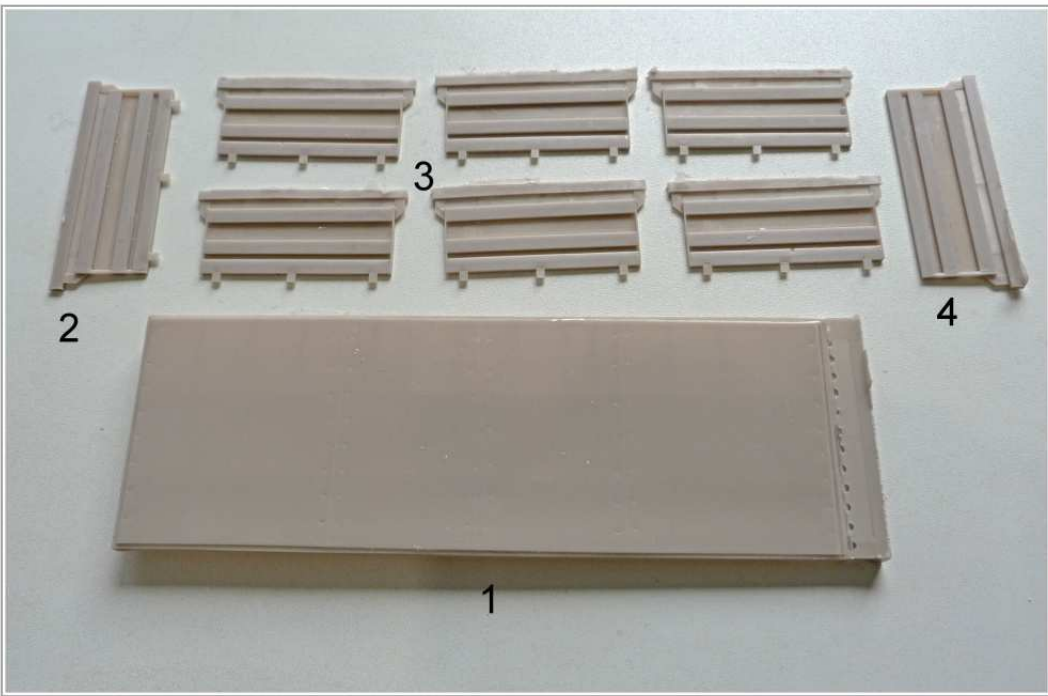
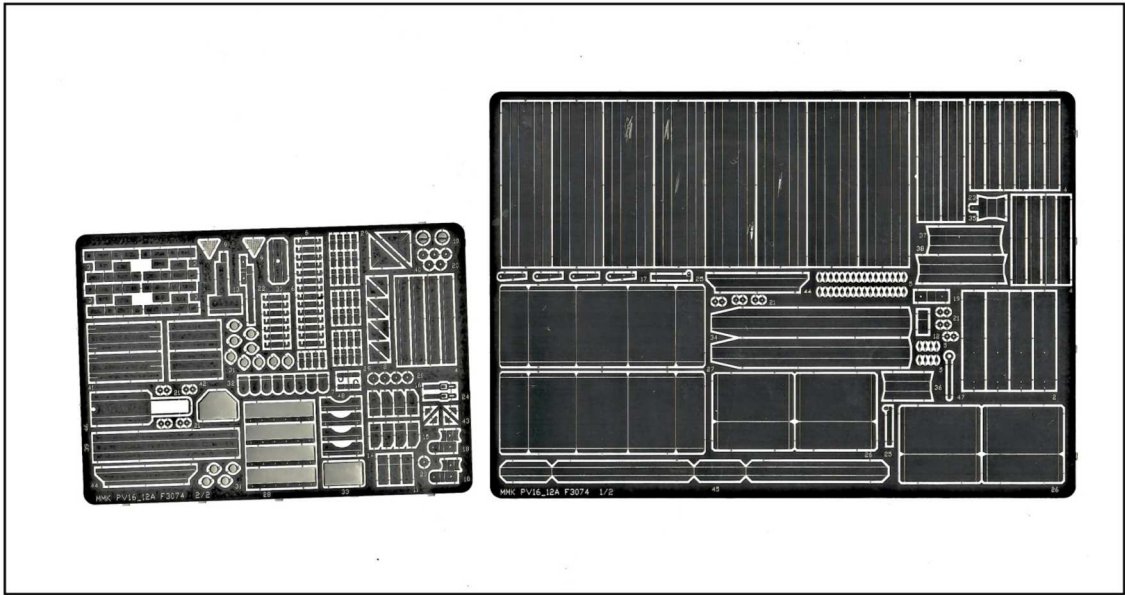

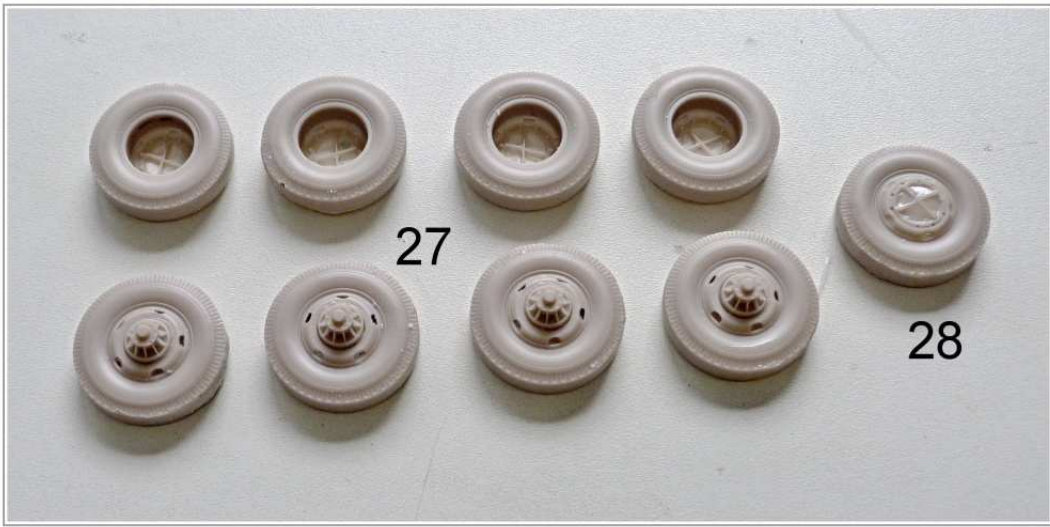
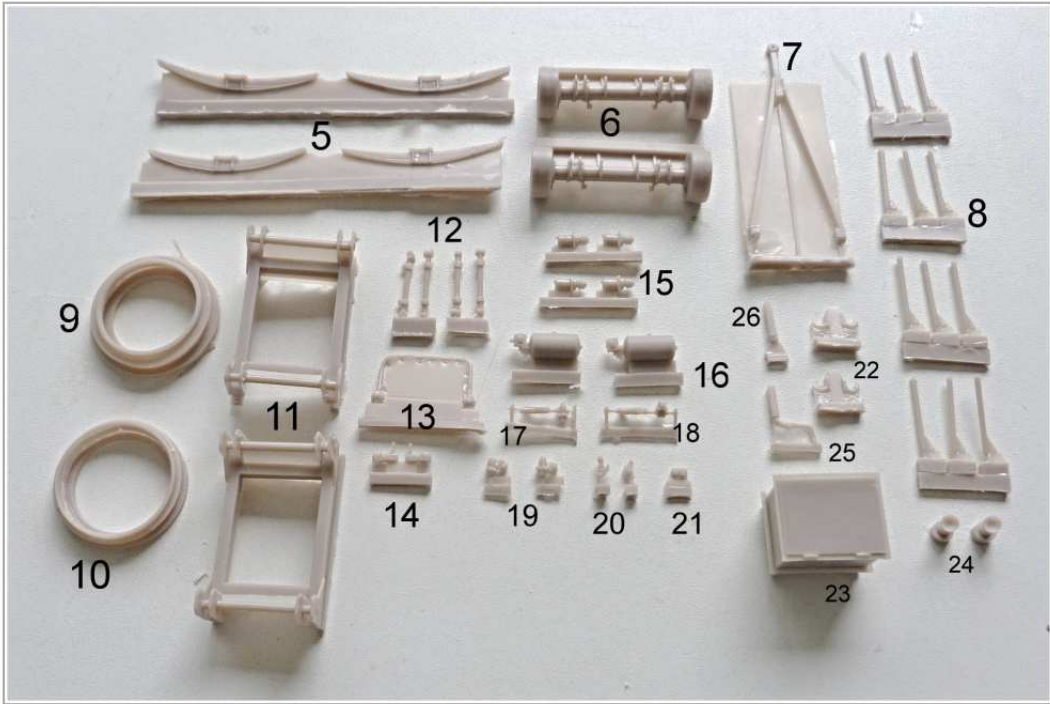

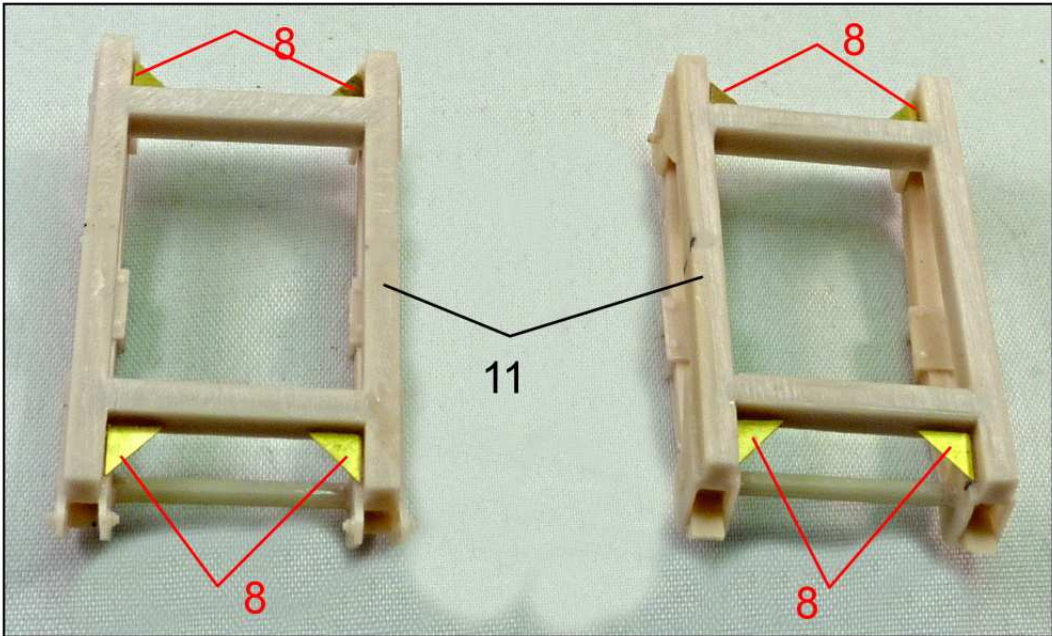
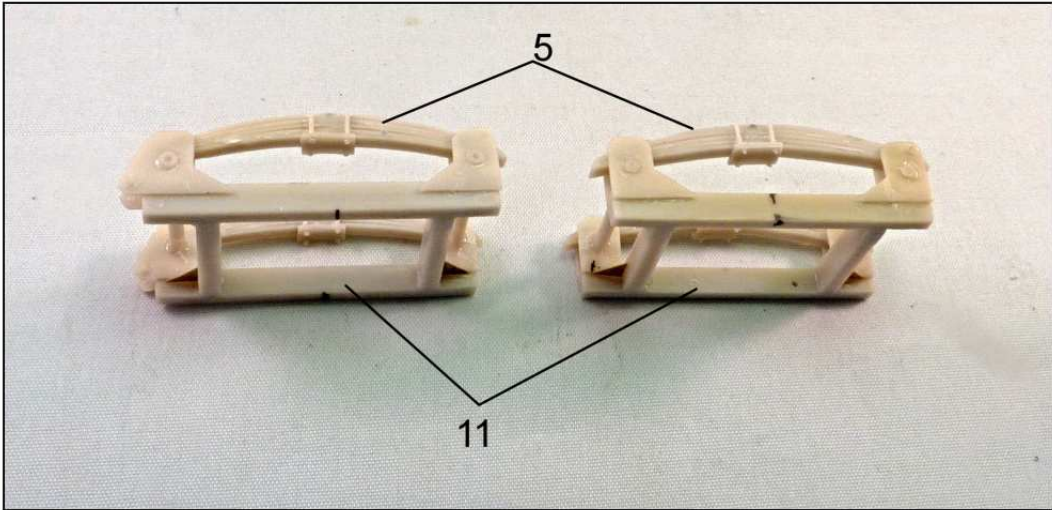

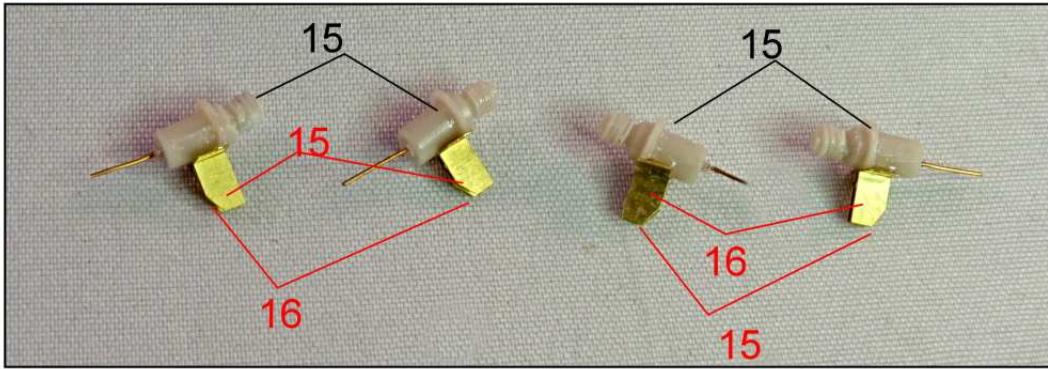
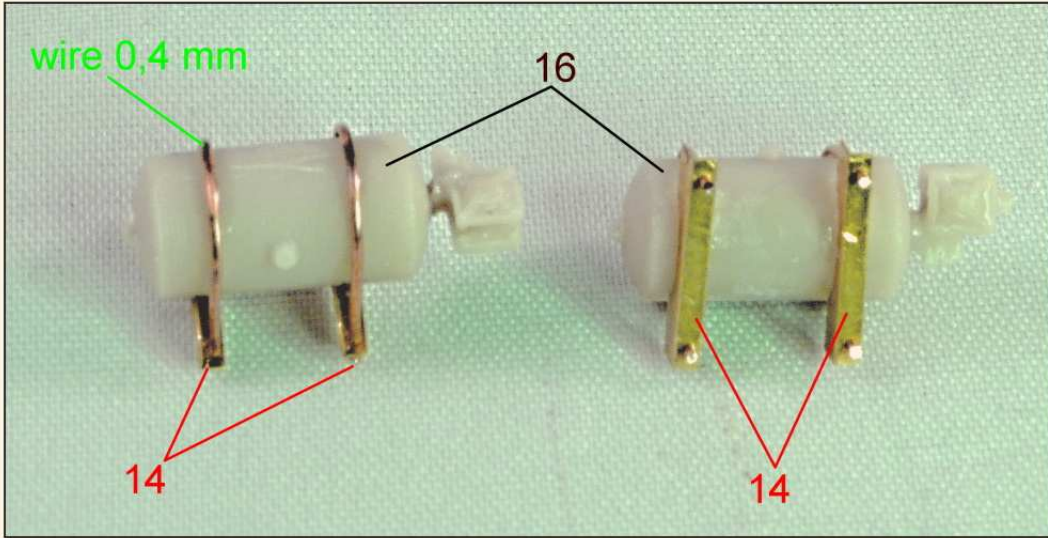

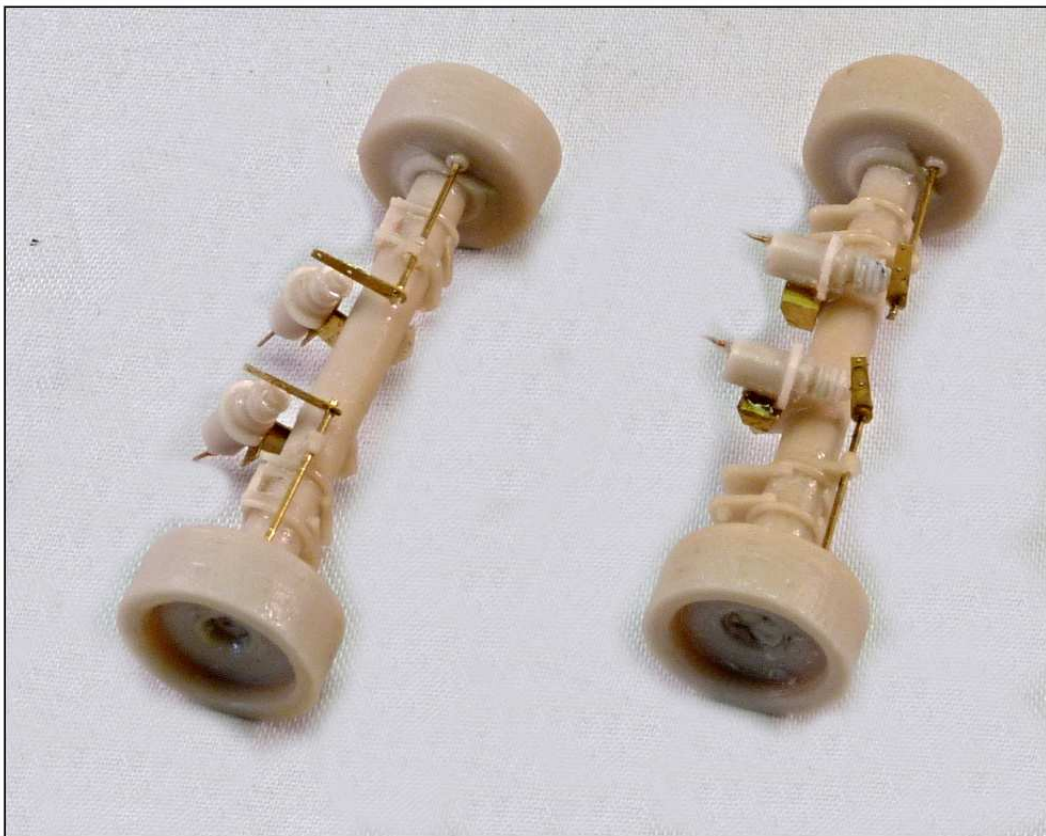
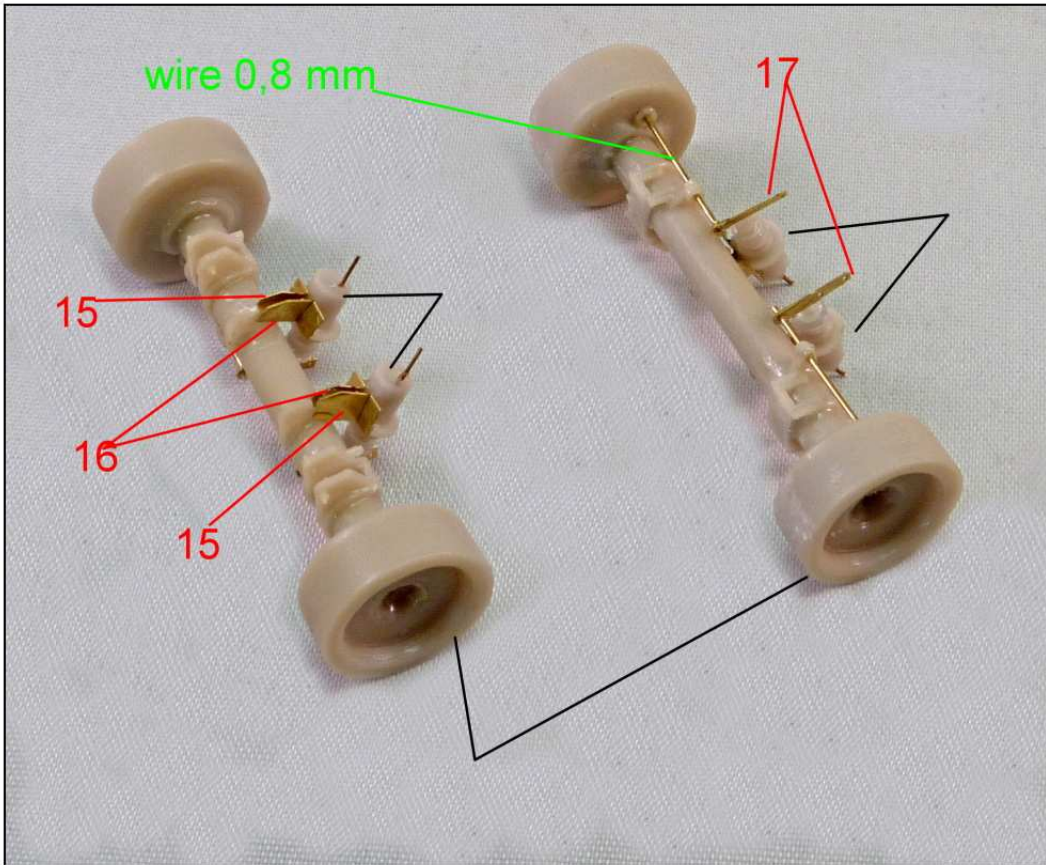



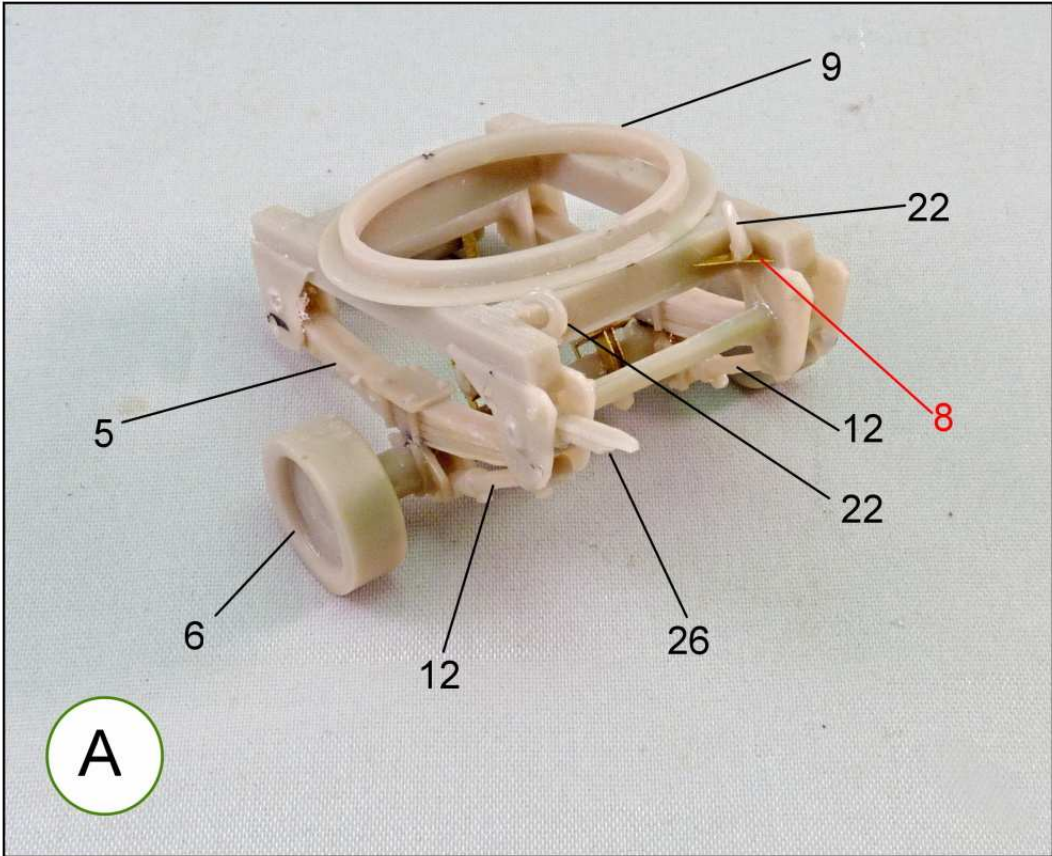



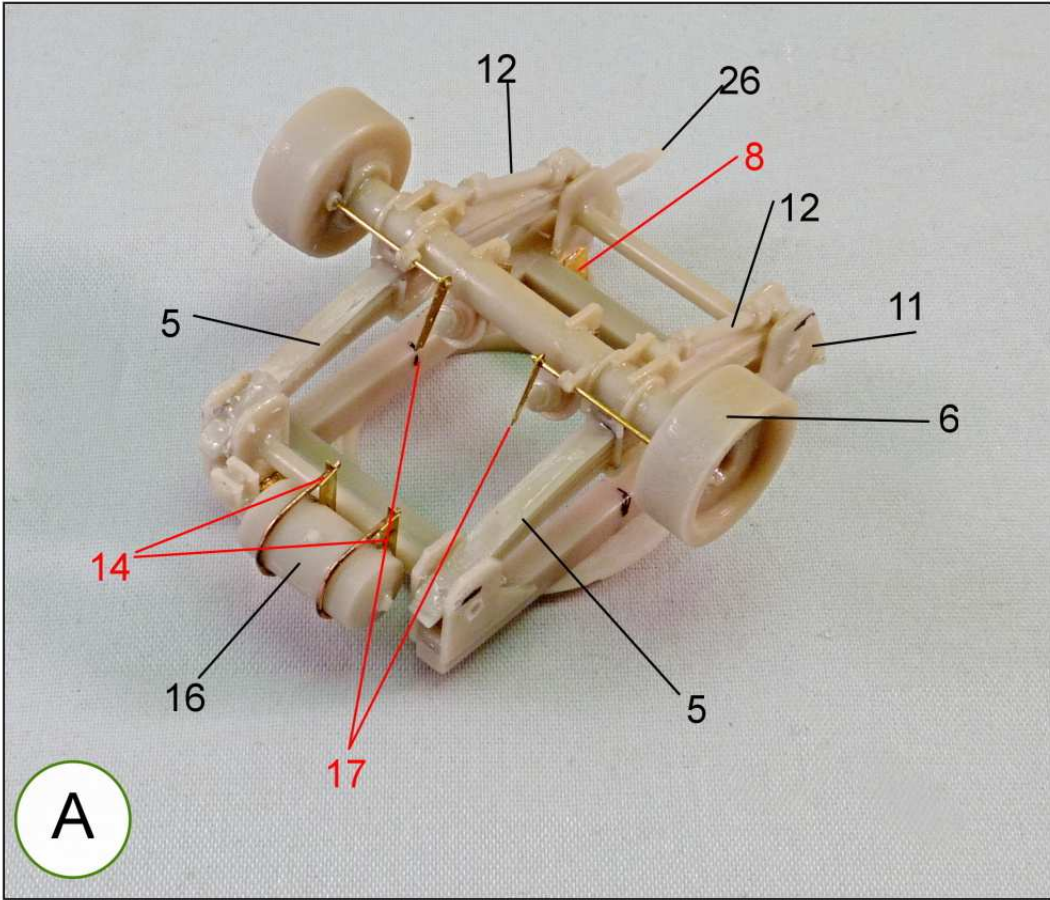

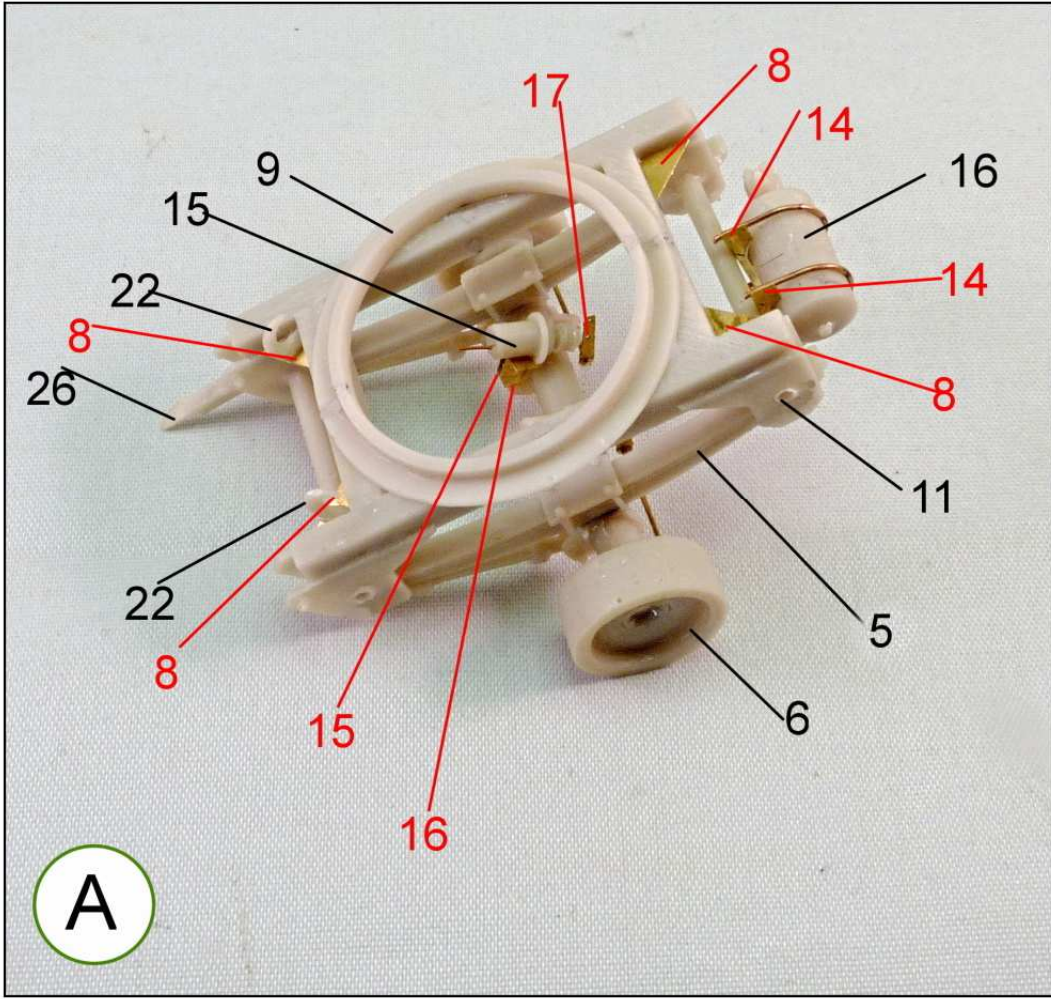



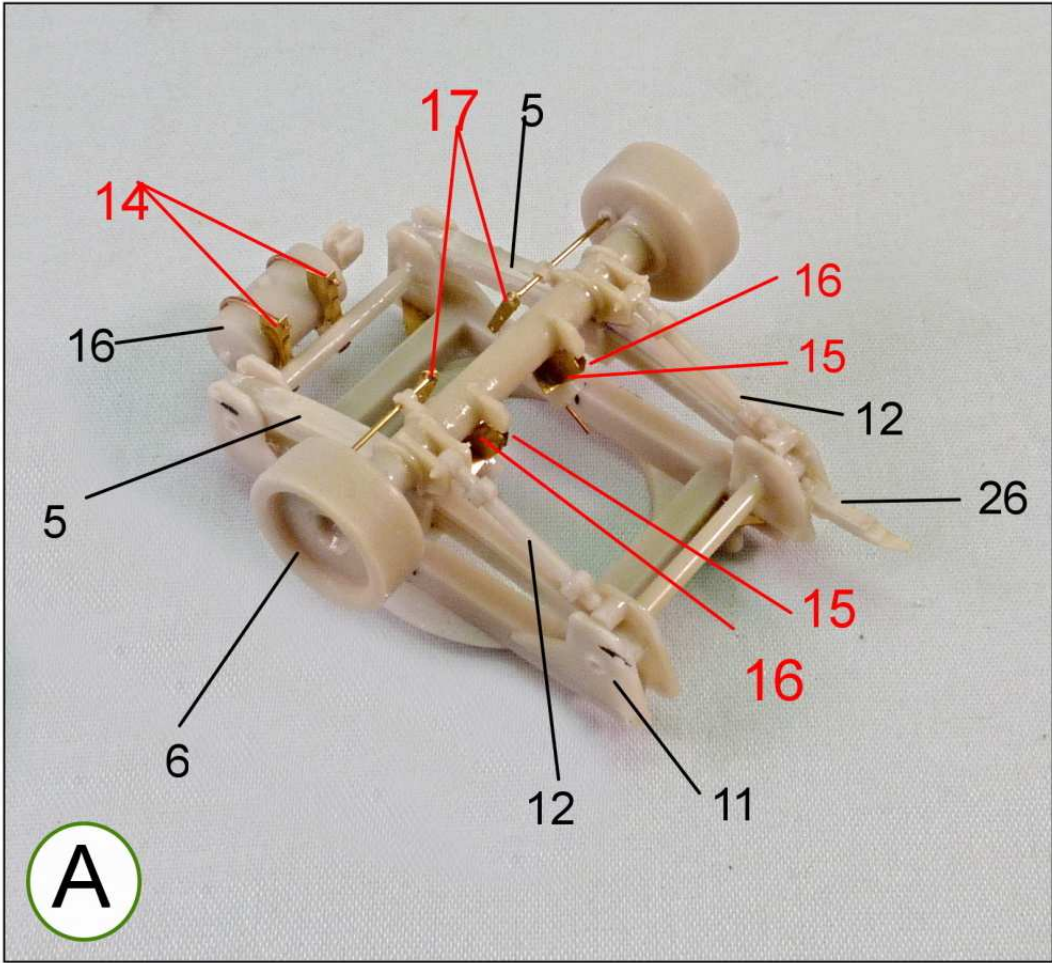

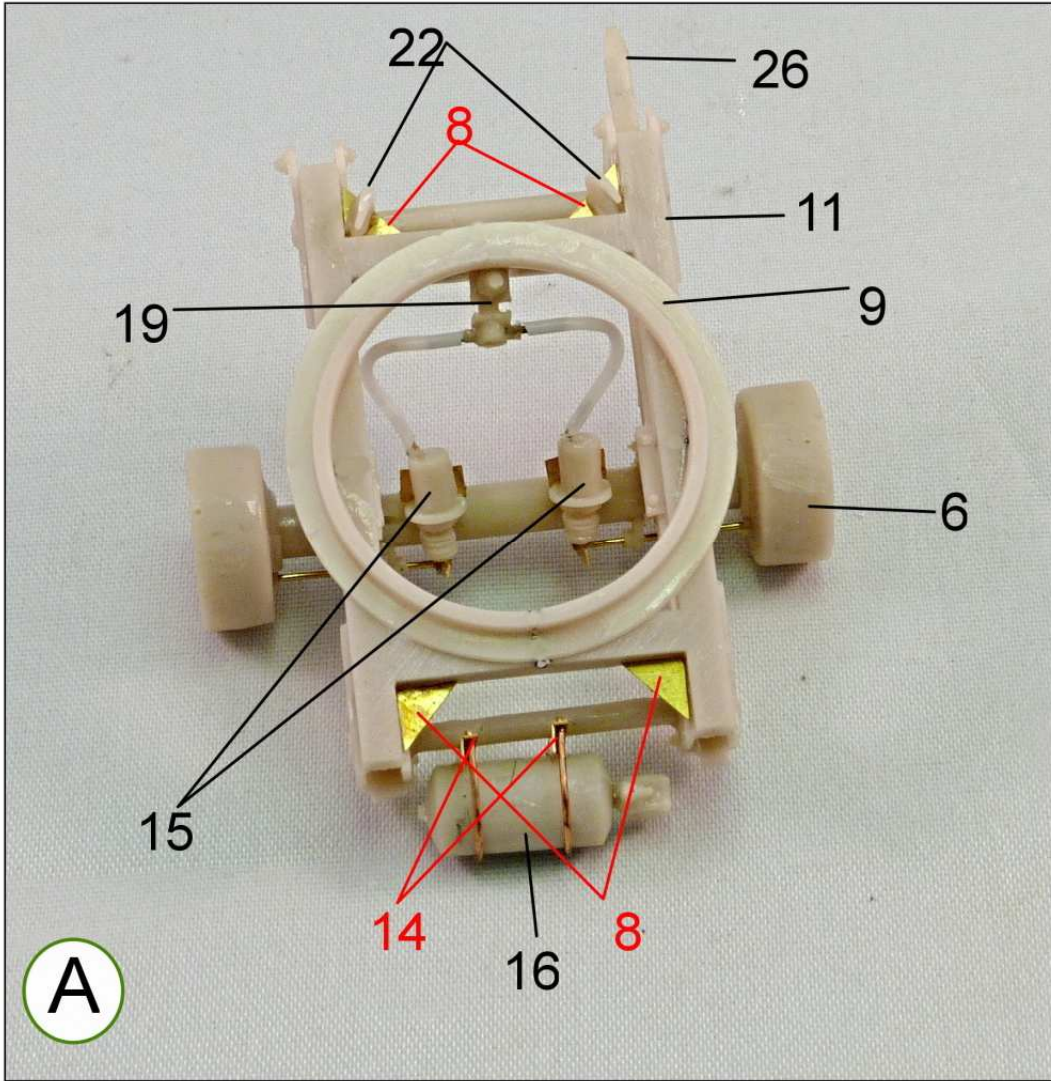

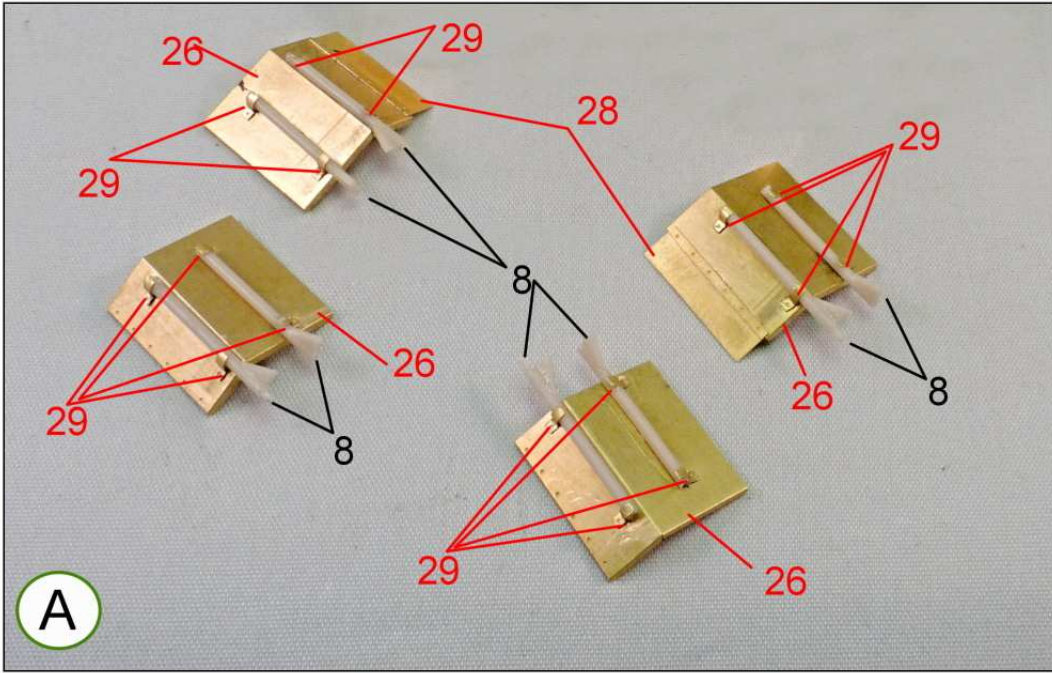

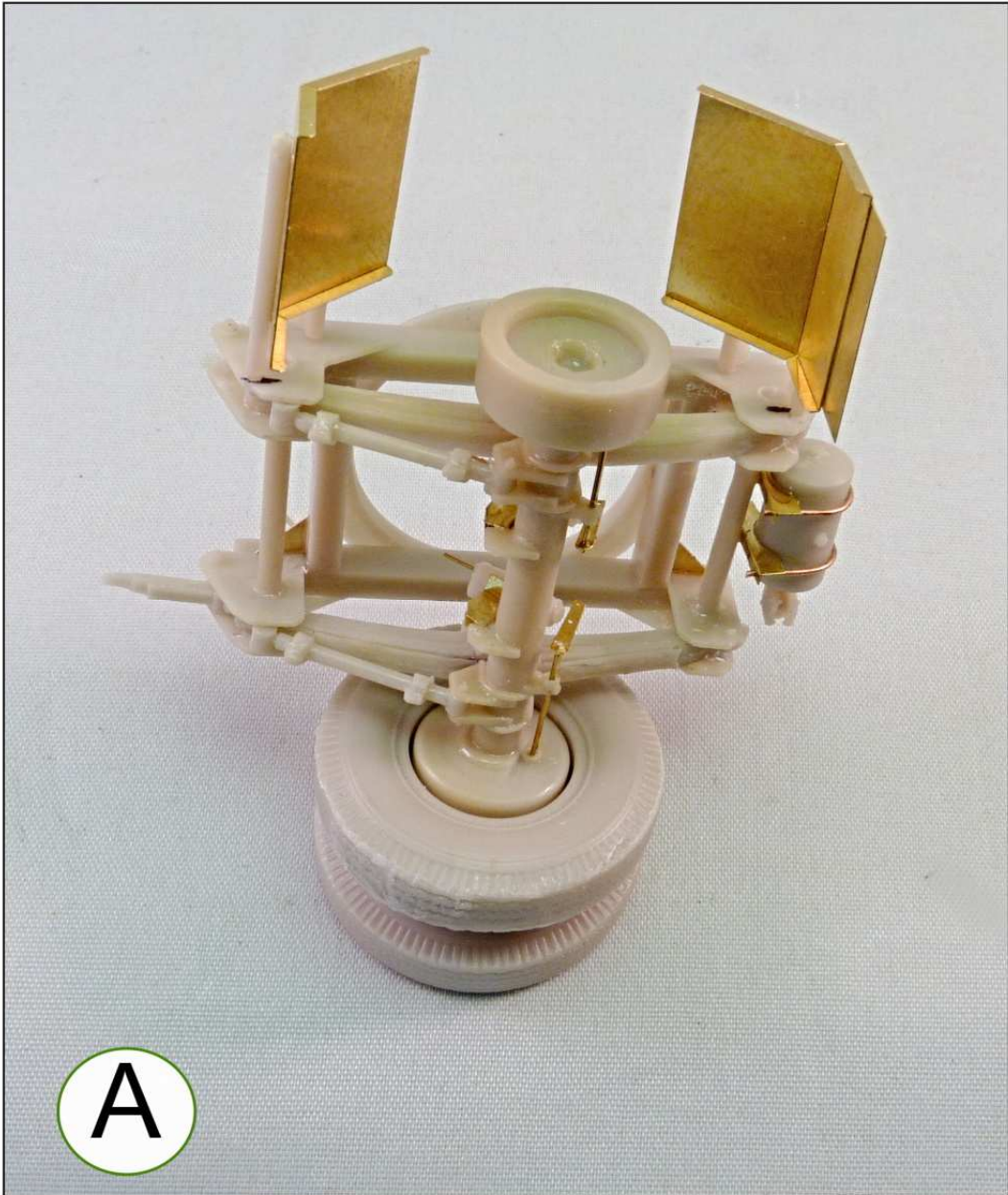

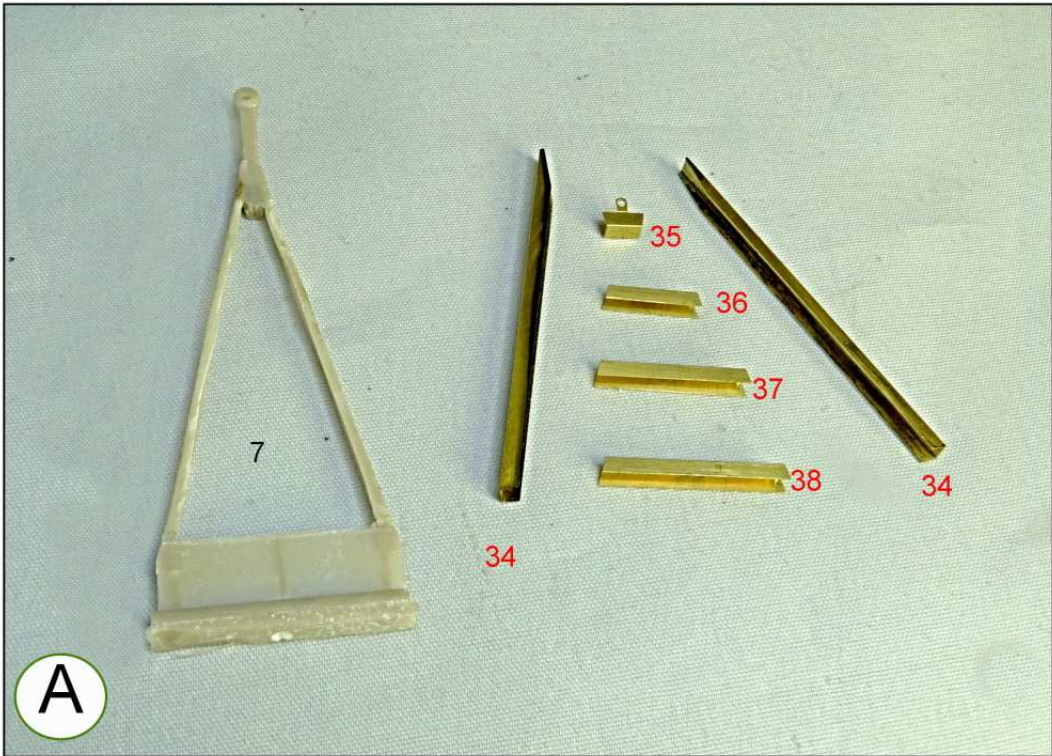
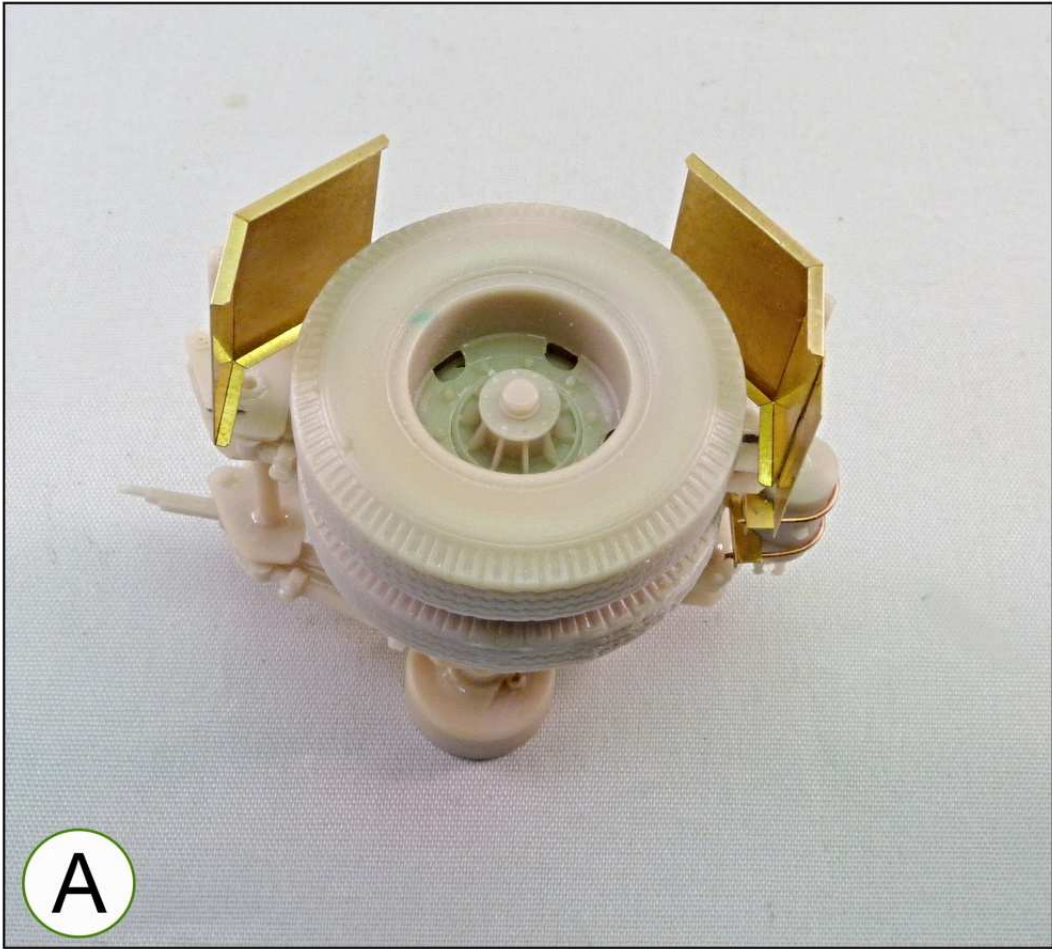



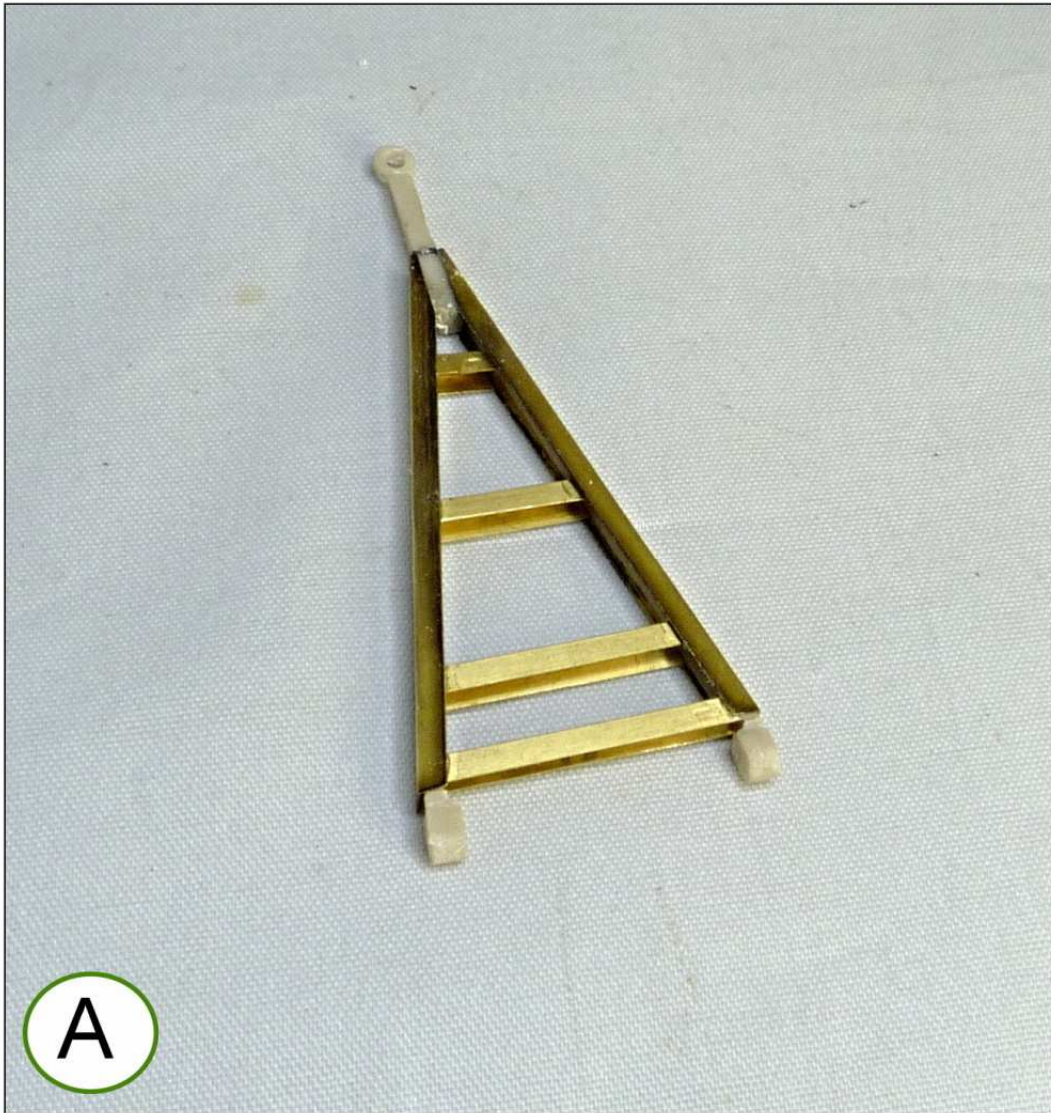
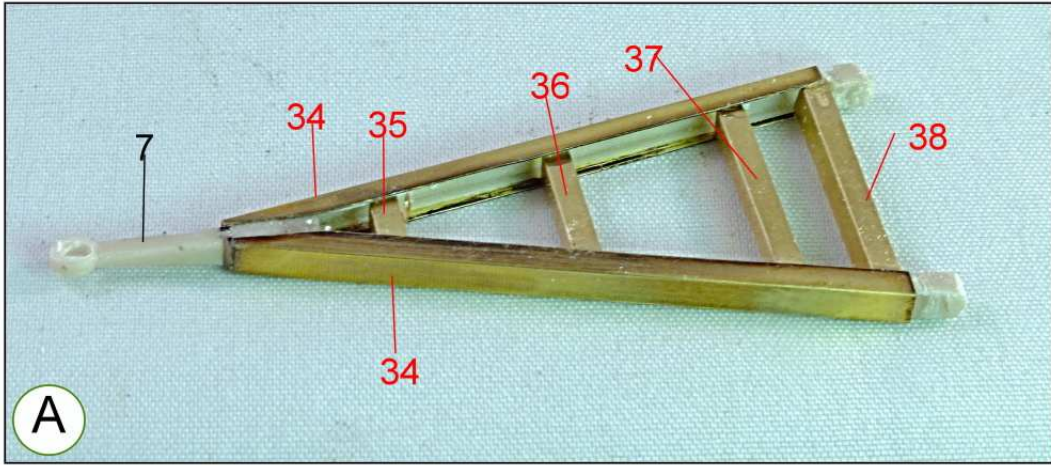

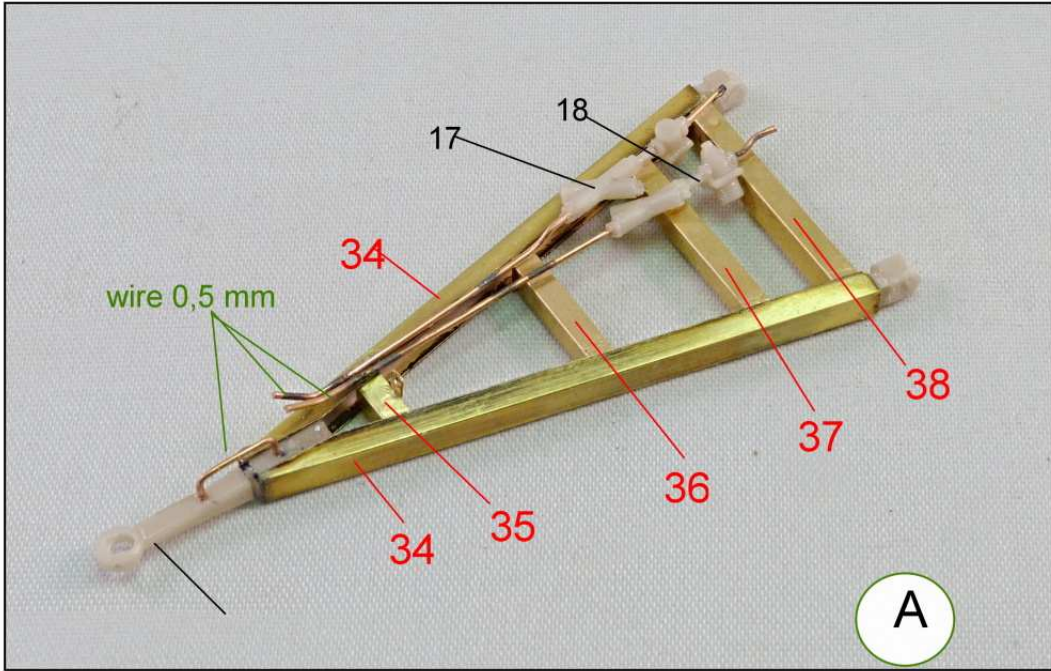

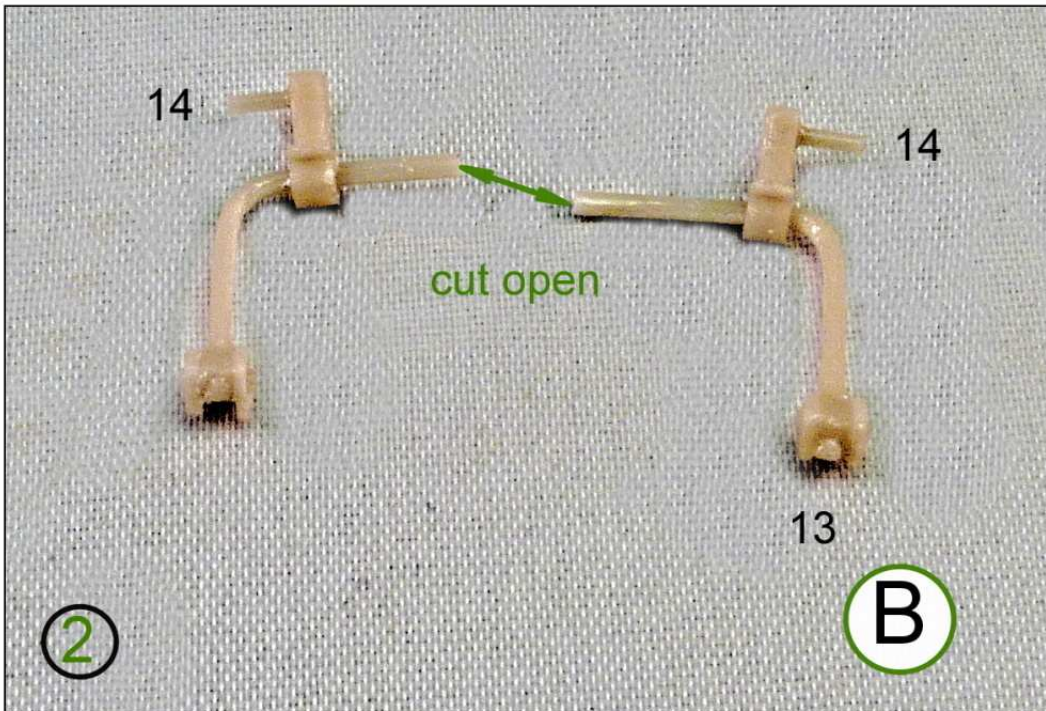
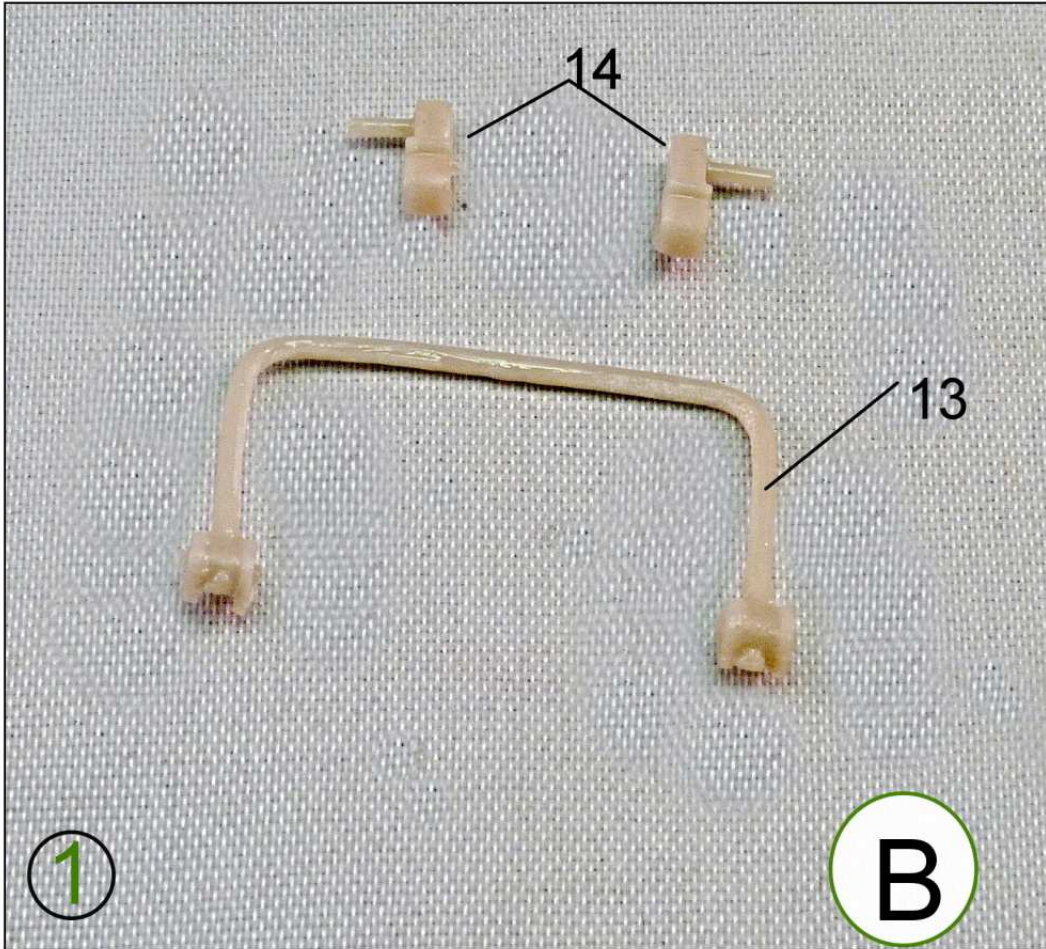

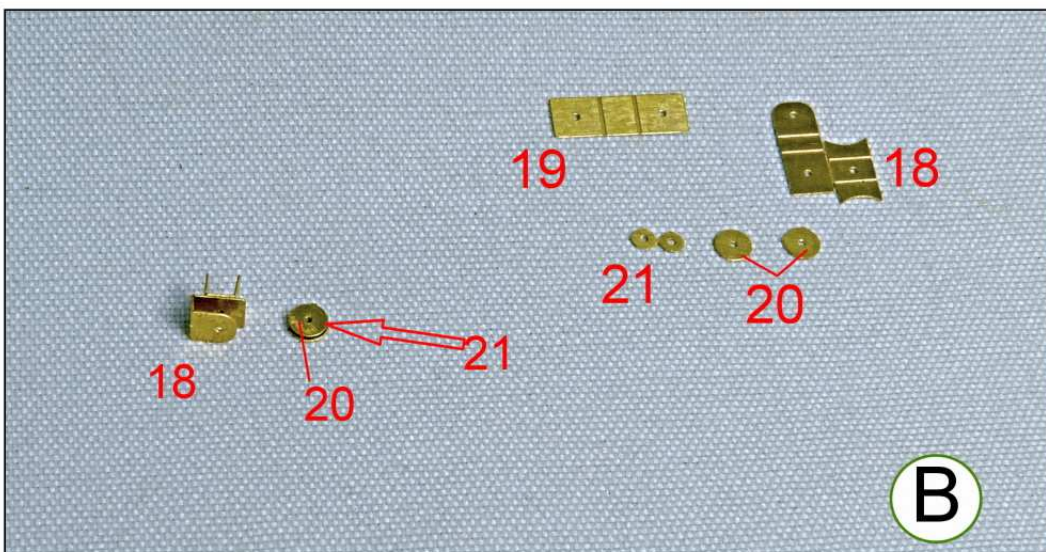
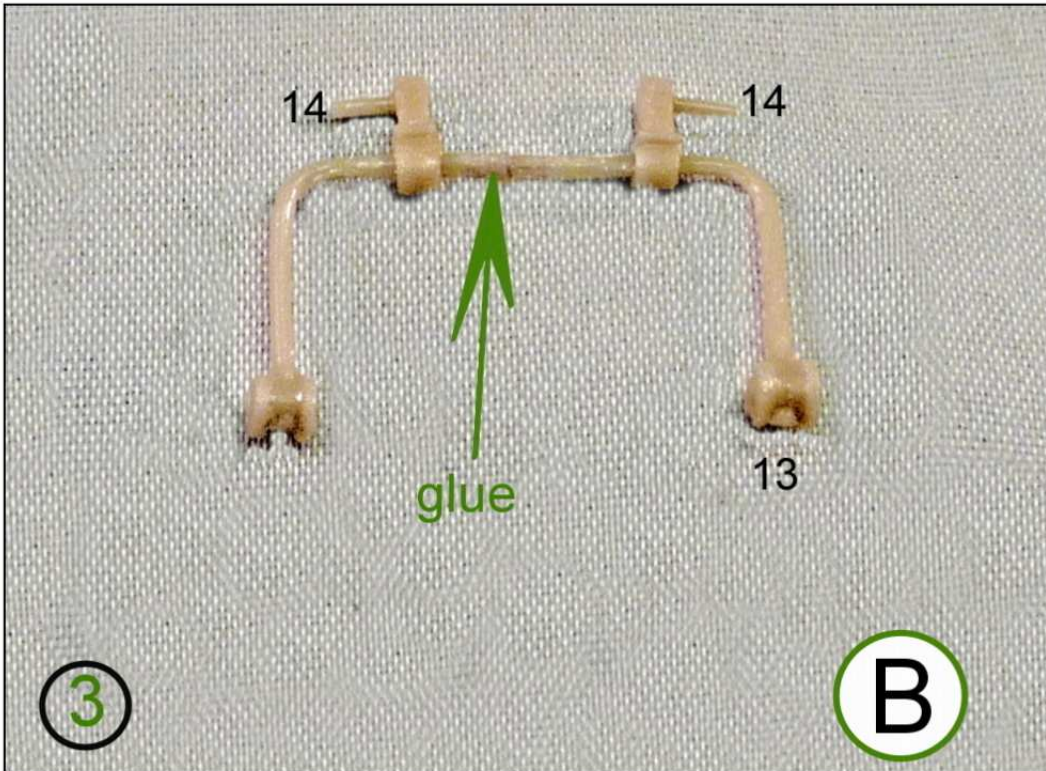

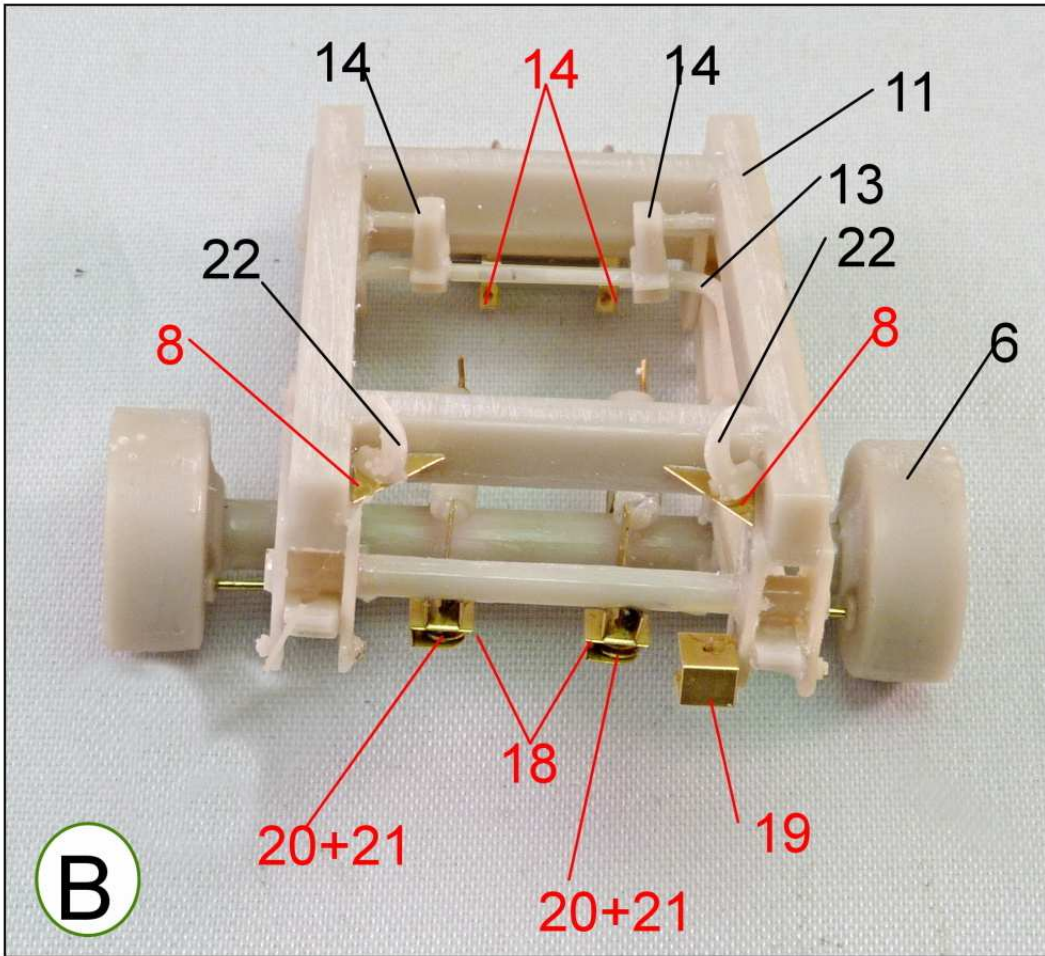

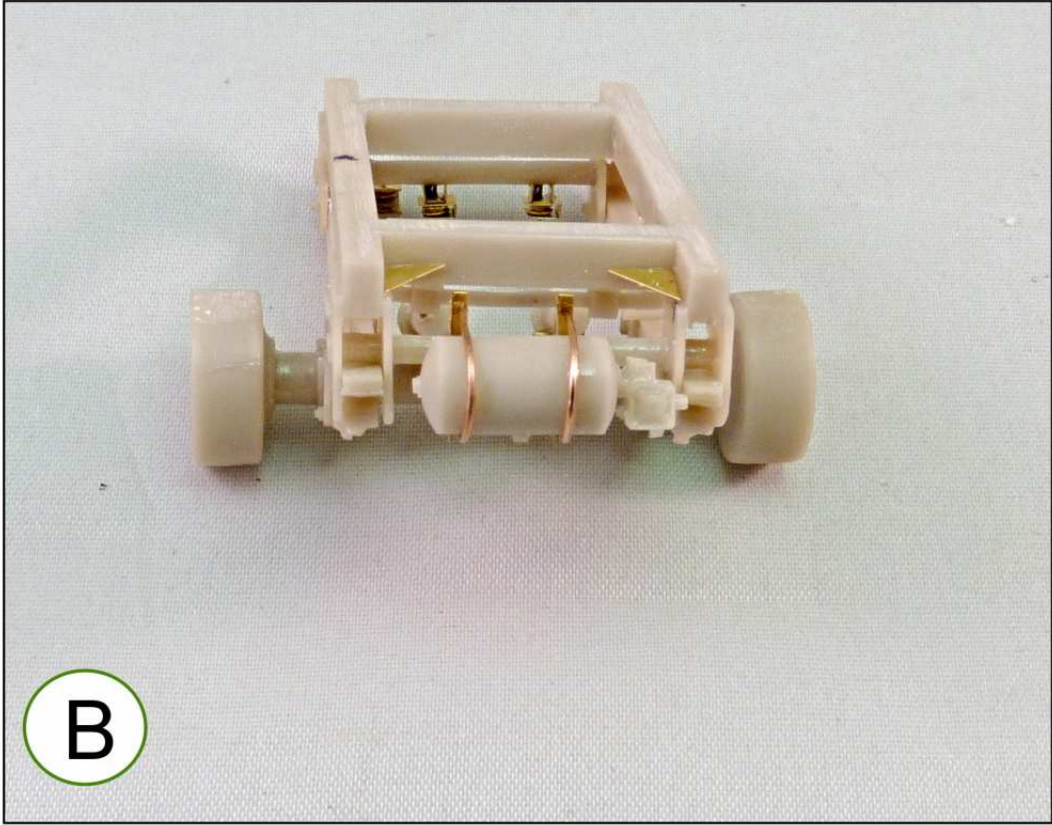

**B**

