

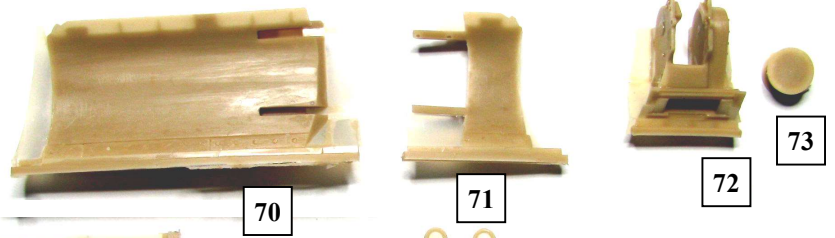

D6K US military service 1/35

F3089

1/14

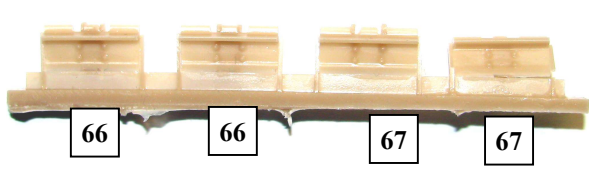
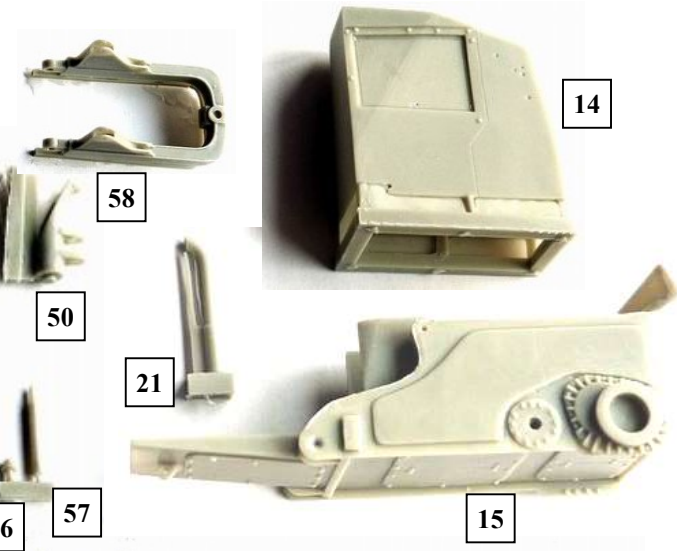
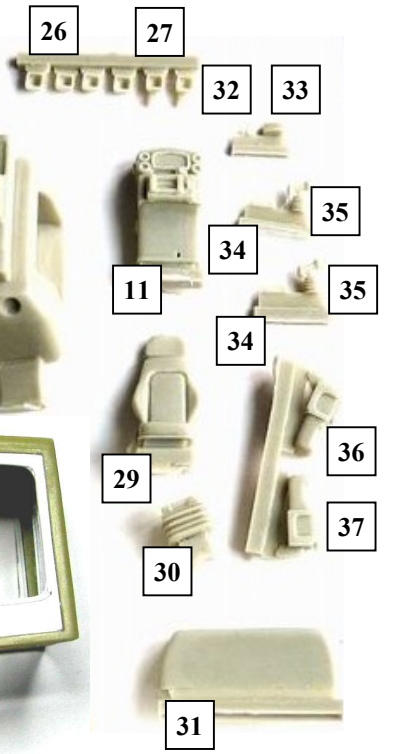
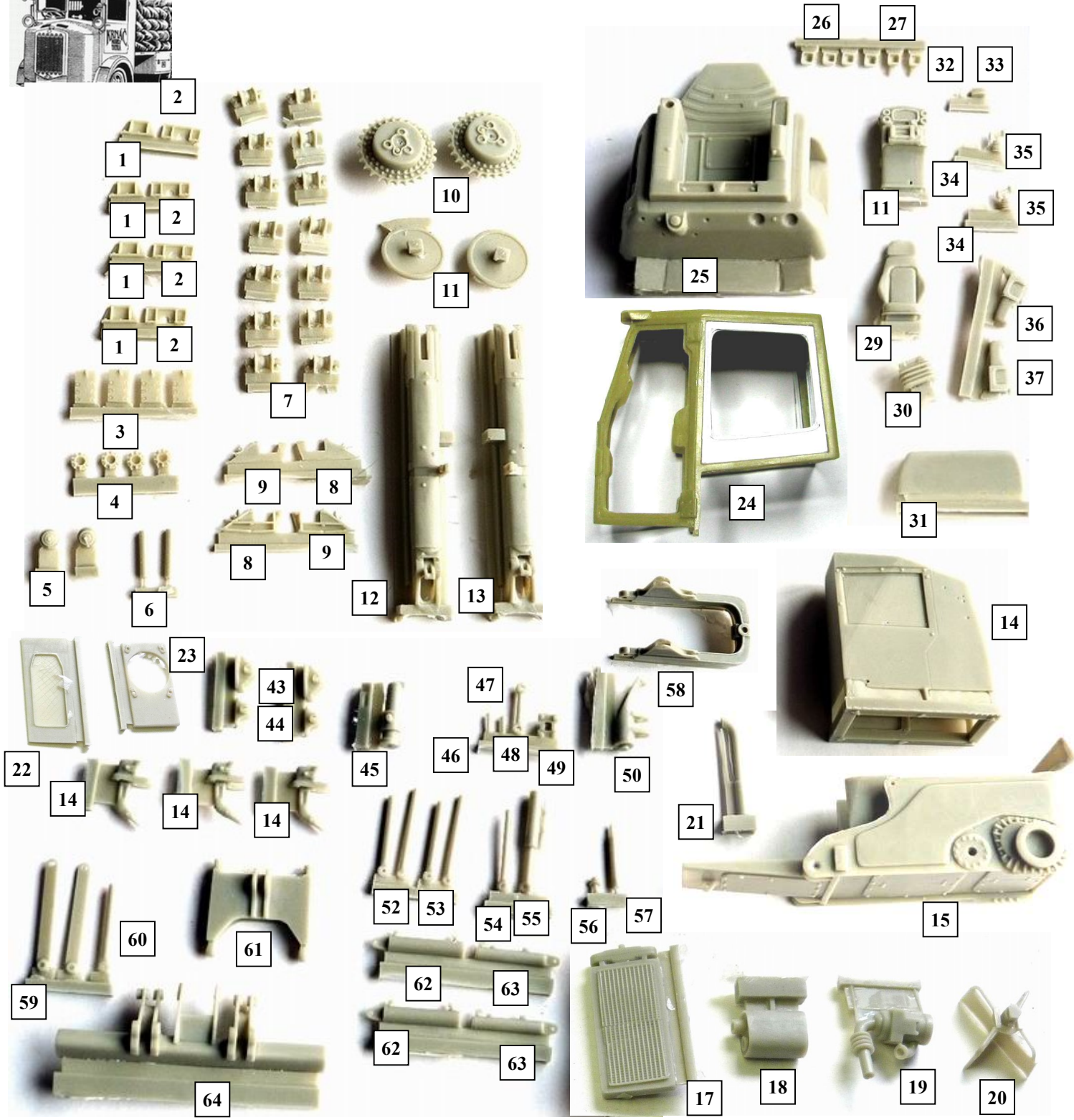

RESIN PARTS xx

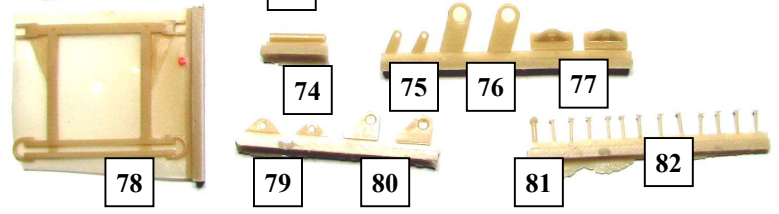

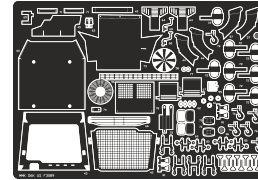
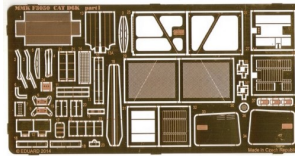
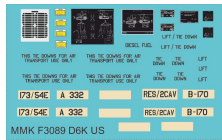

DECALS

PHOTO-ETCHED PARTS

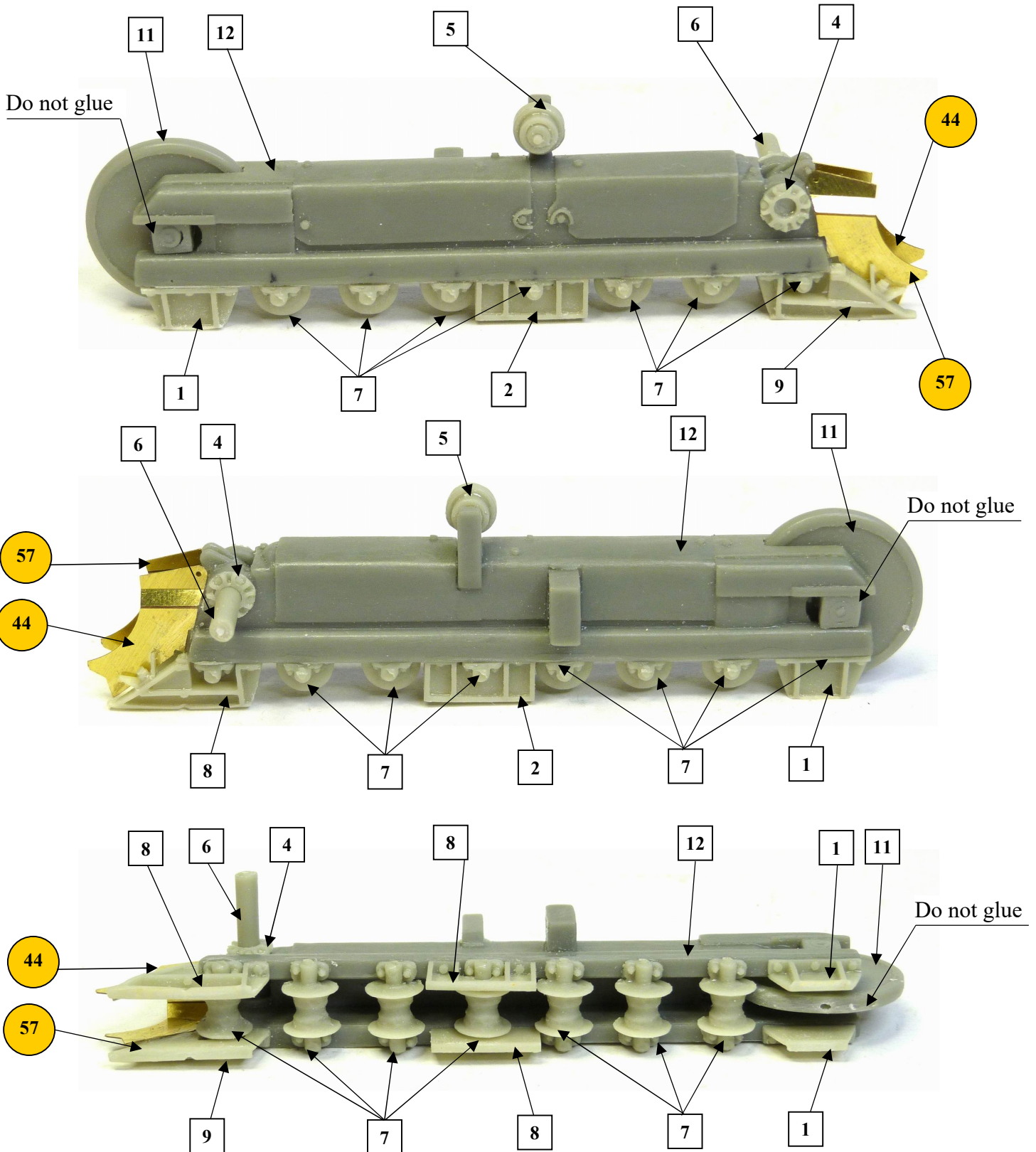

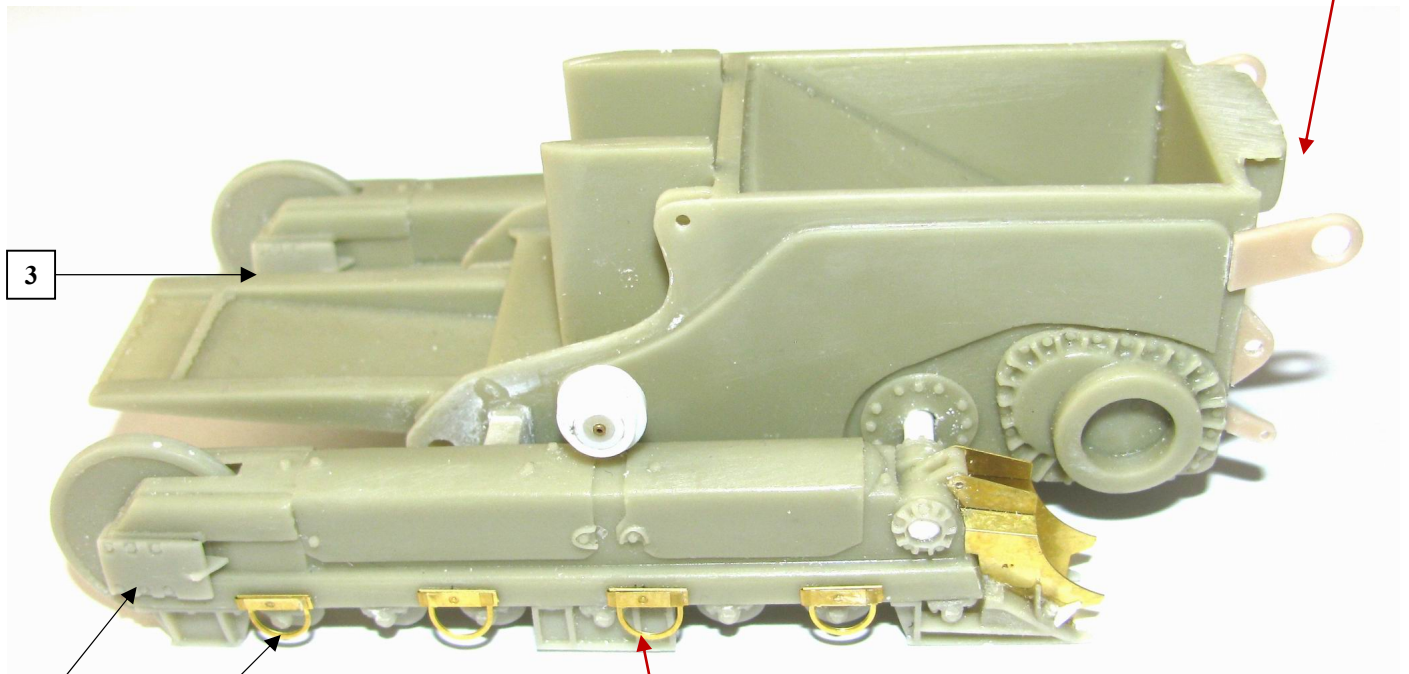
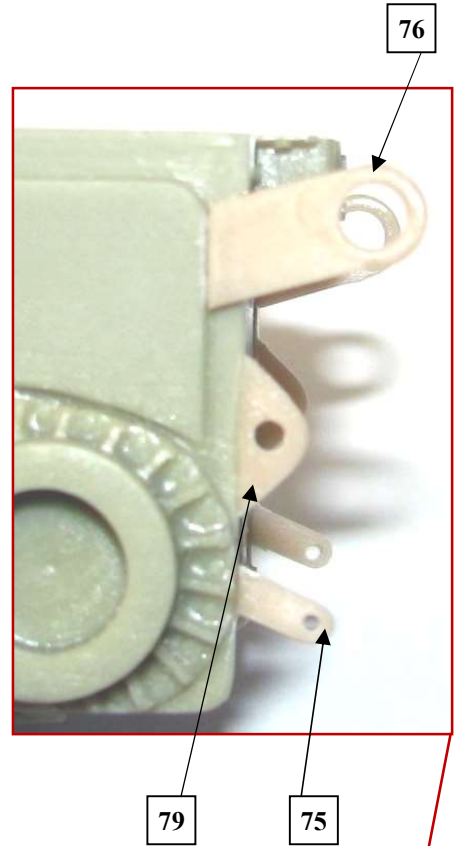
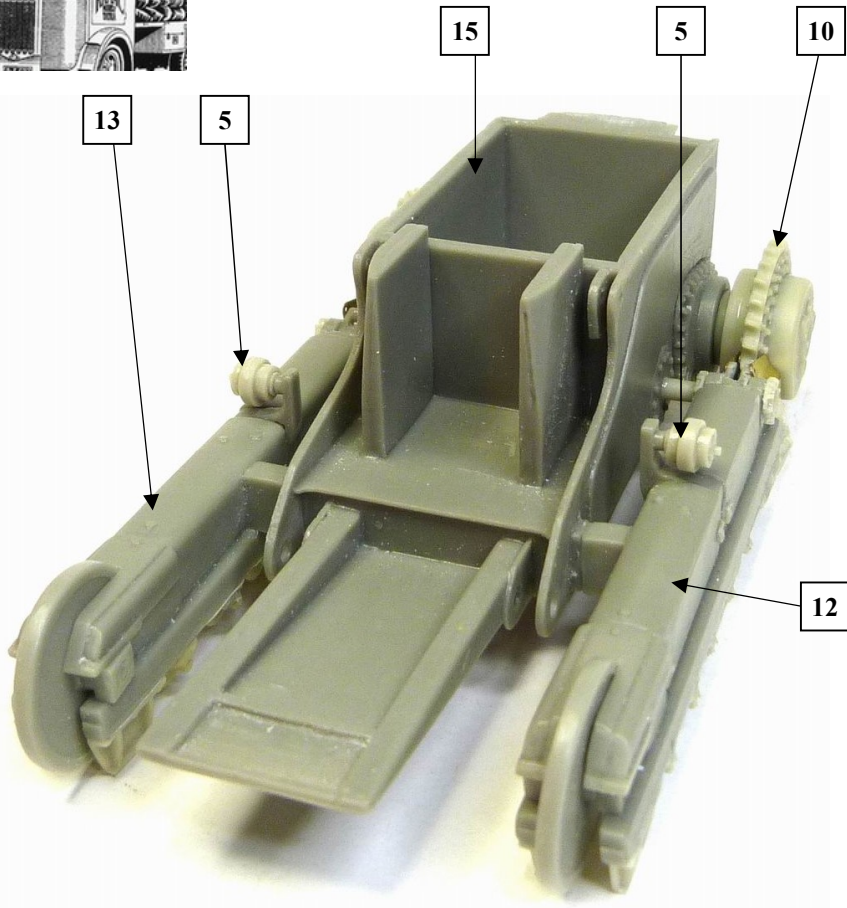



Winch PA50
Naviják PA50

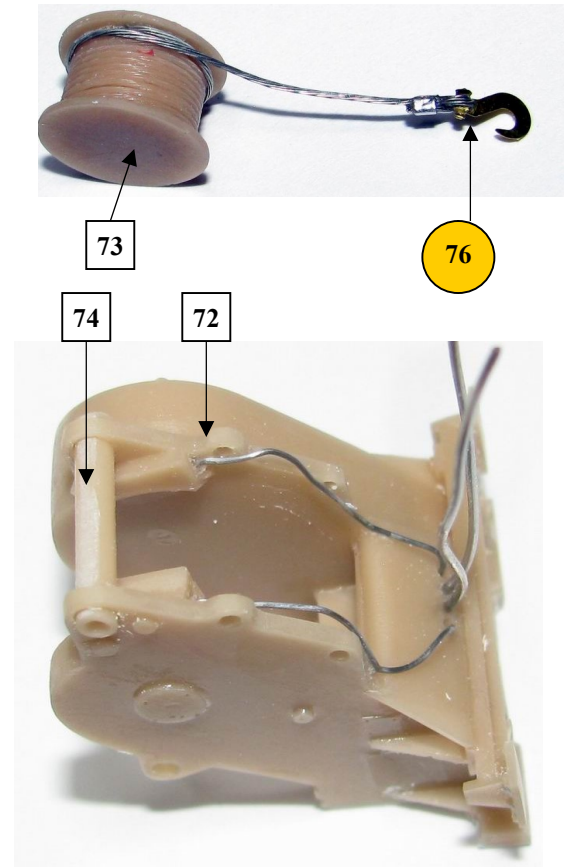
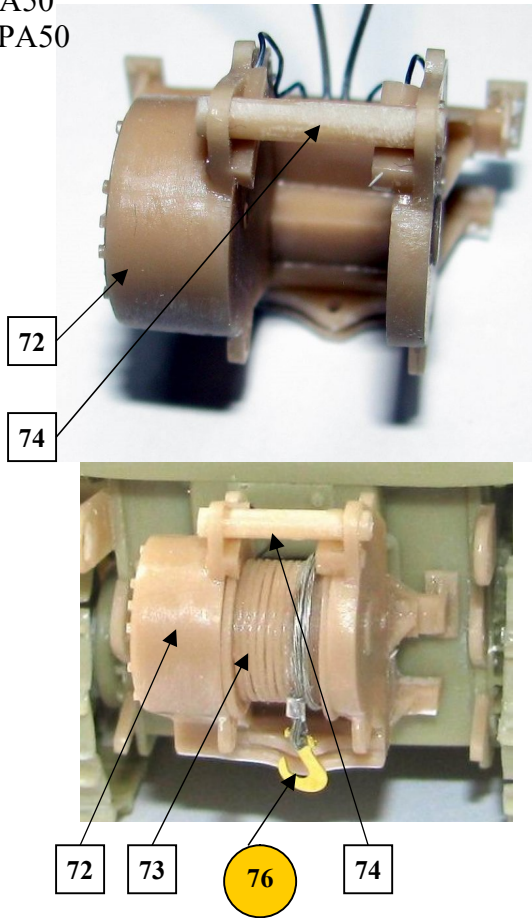

Multi-Shank Riepper
Rozrývač

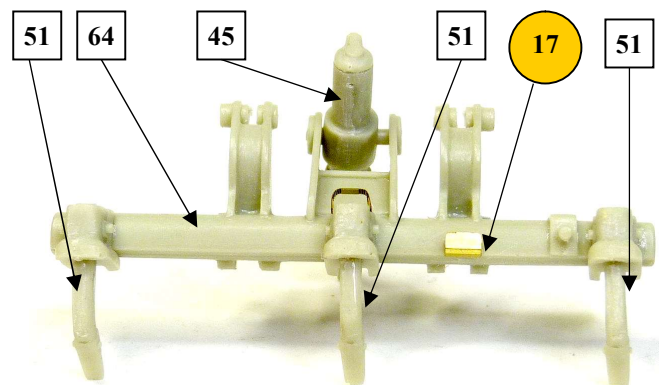
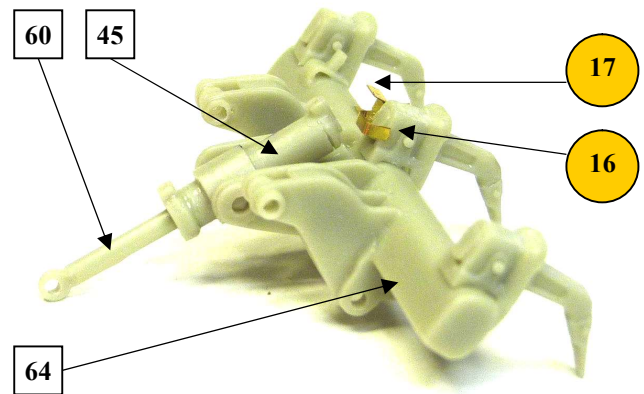
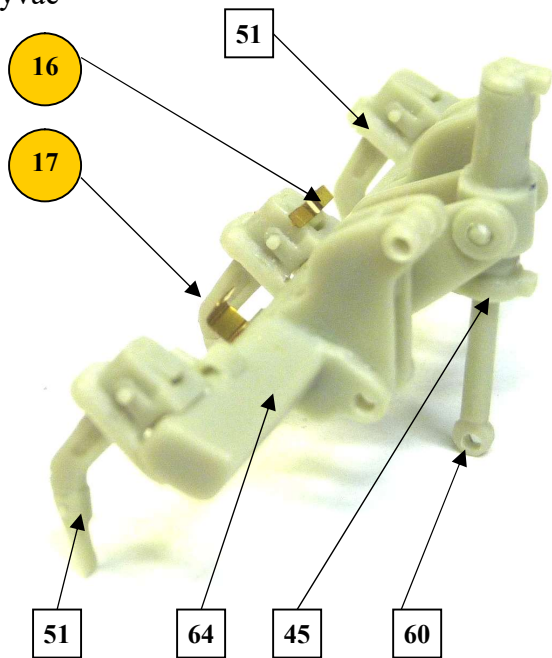



Multi-Shank Riepper
Rozrývač

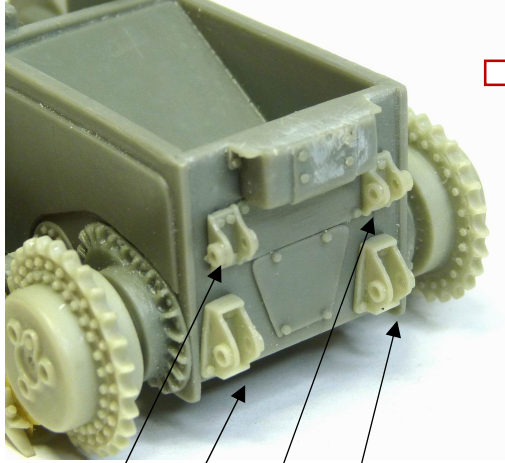

44 43 44 43

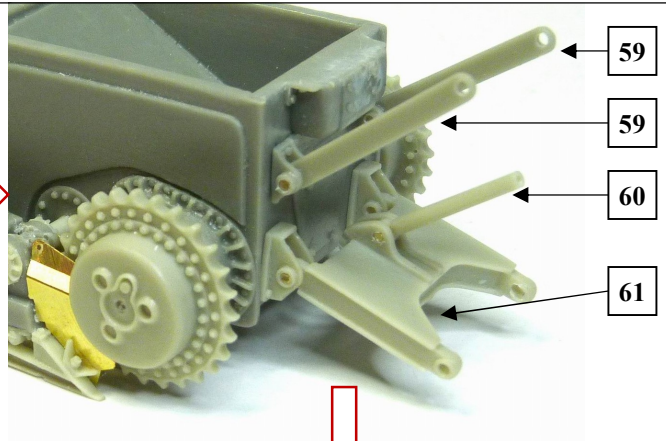

59
59
60
61

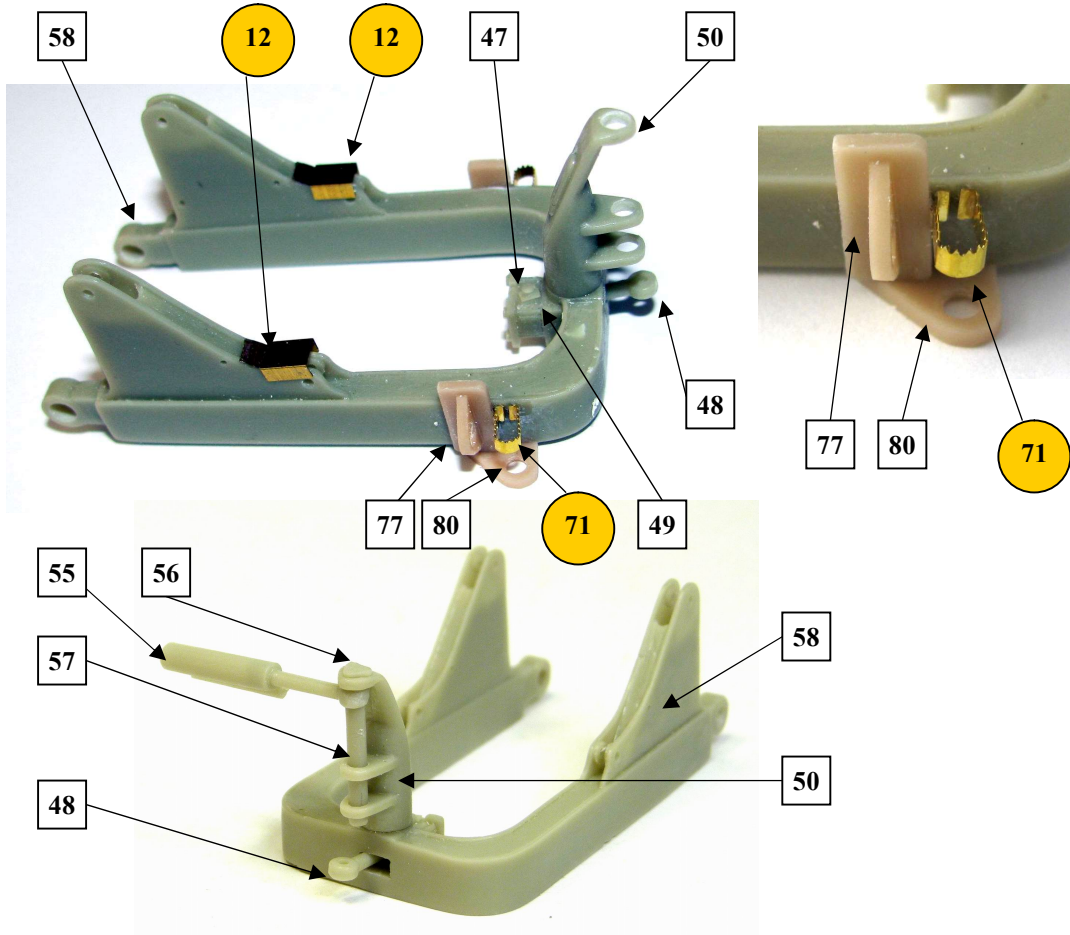
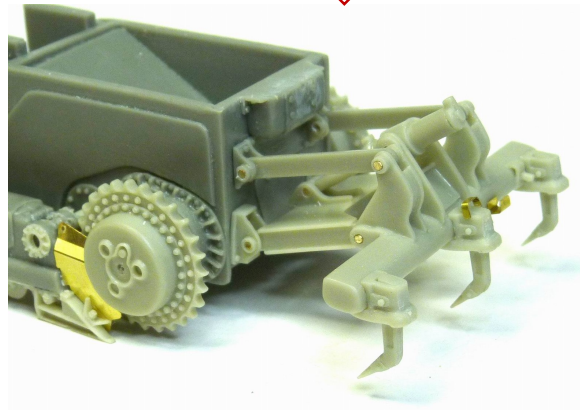

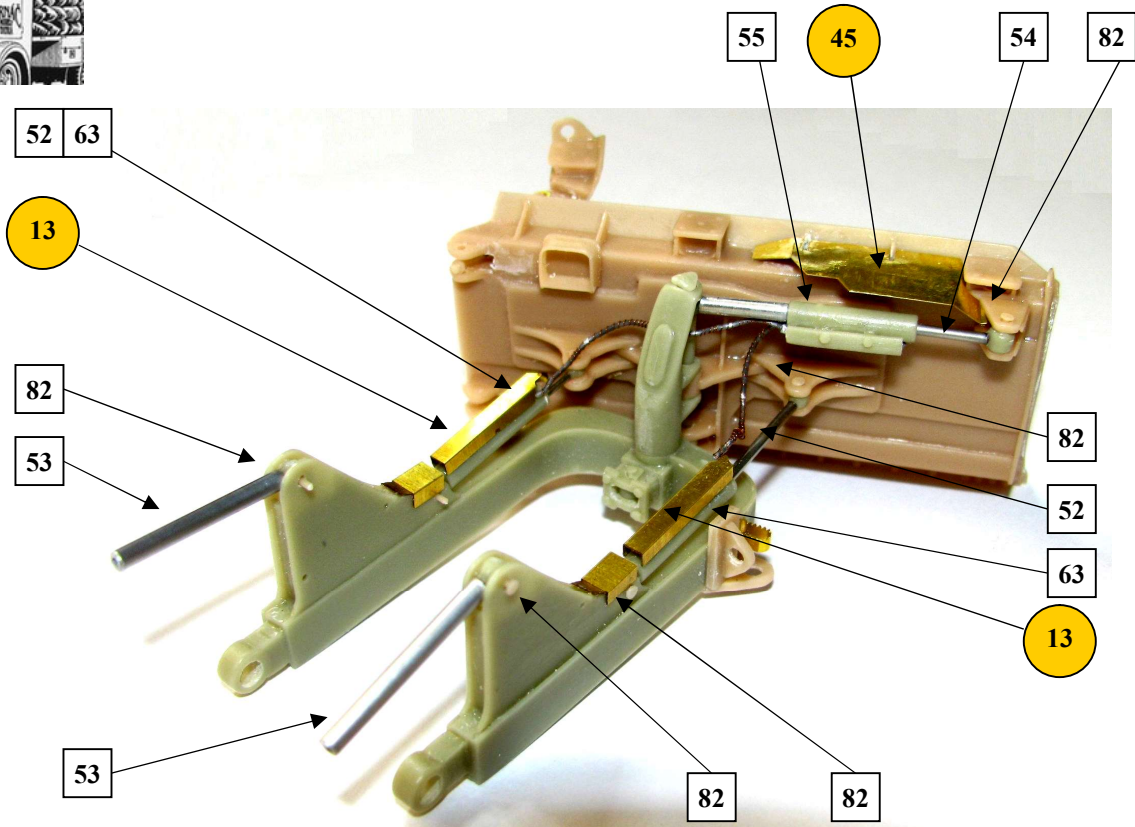

Transport position

Operational position

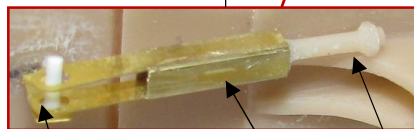
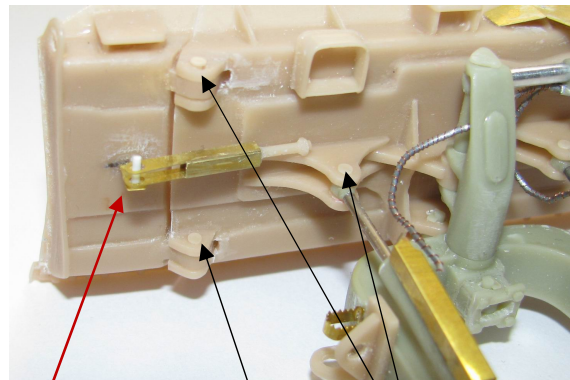
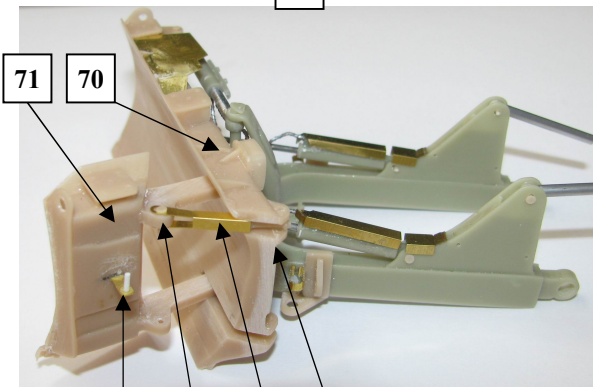
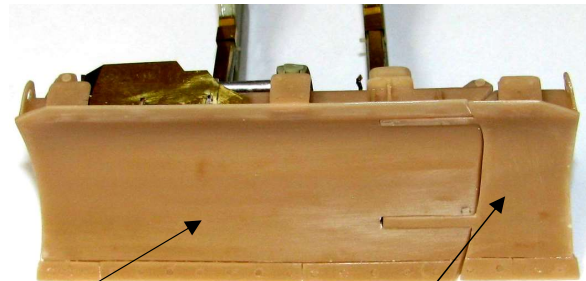
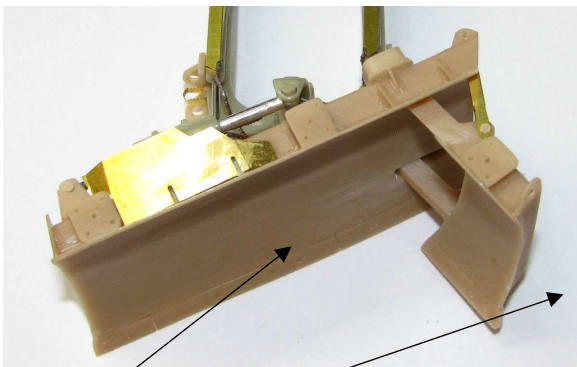

- 74
- 82
- 75
- 81

- 75
- 81

plastic rod $\varnothing 0,6\text{mm} - 3\text{mm}$

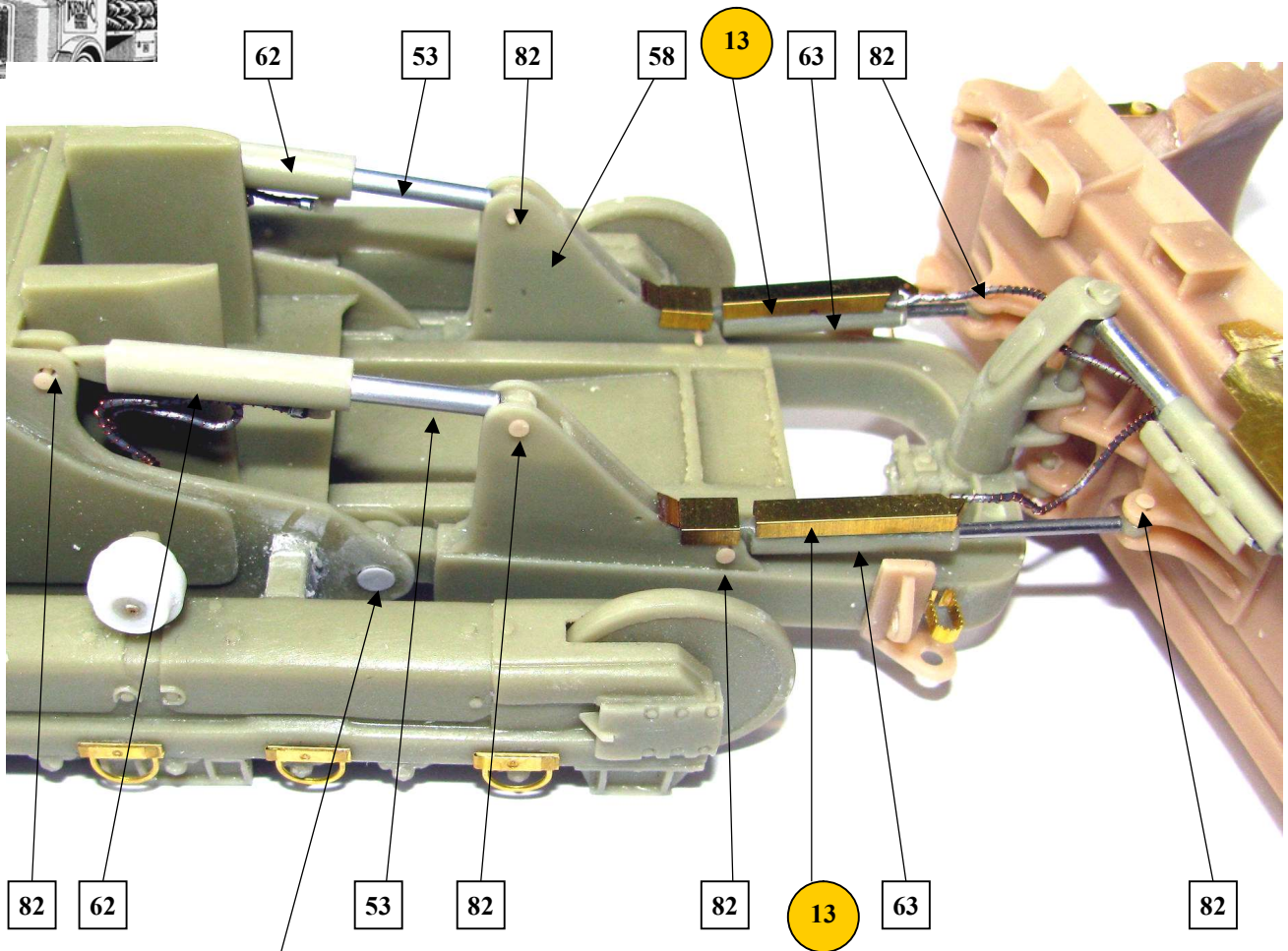

plastic rod $\varnothing 2\text{mm} - 4\text{mm}$

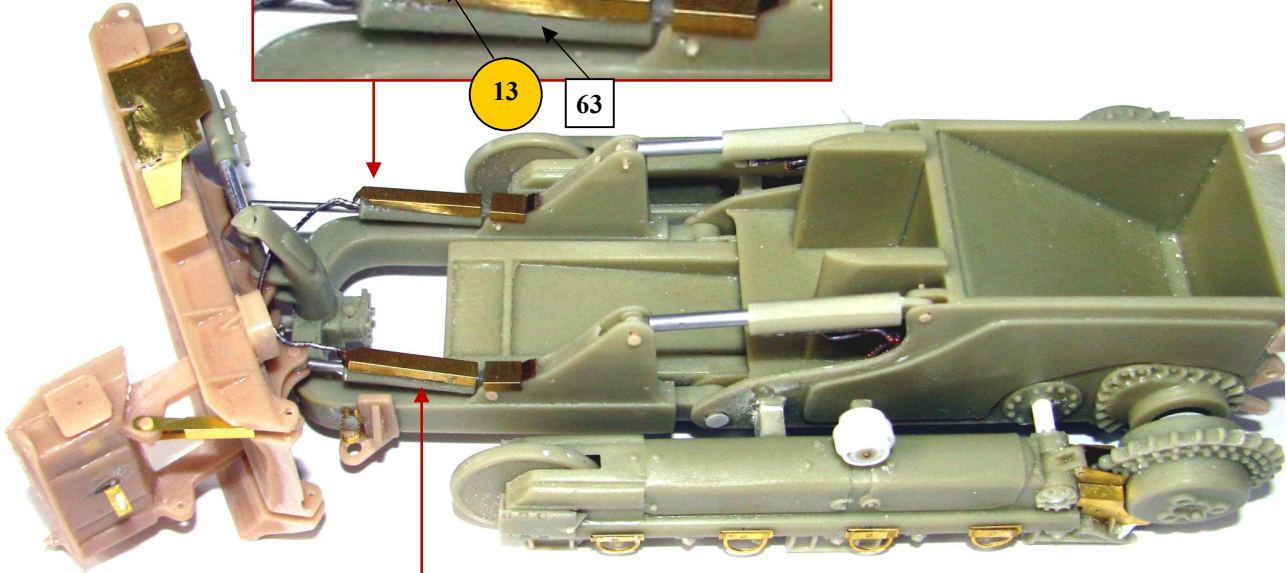
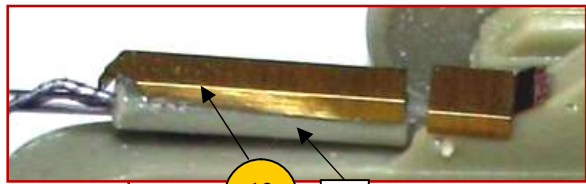

63 13



D6K US military service 1/35

F3089

8/14

25

plastic rod $\varnothing 0,6mm - 2mm$

73

63

25

9

73

63

9

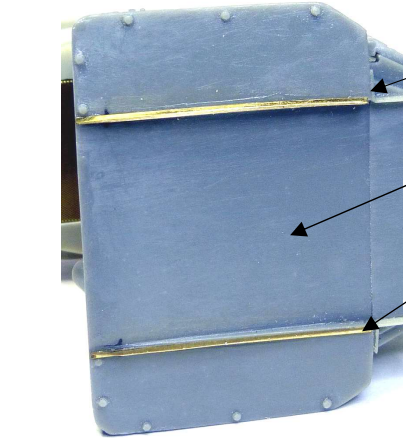

15

25

15

28

30

36

35

29

35

37

12

12

29

37

35

28

37

33

47

53

50

32

52

53

49

48

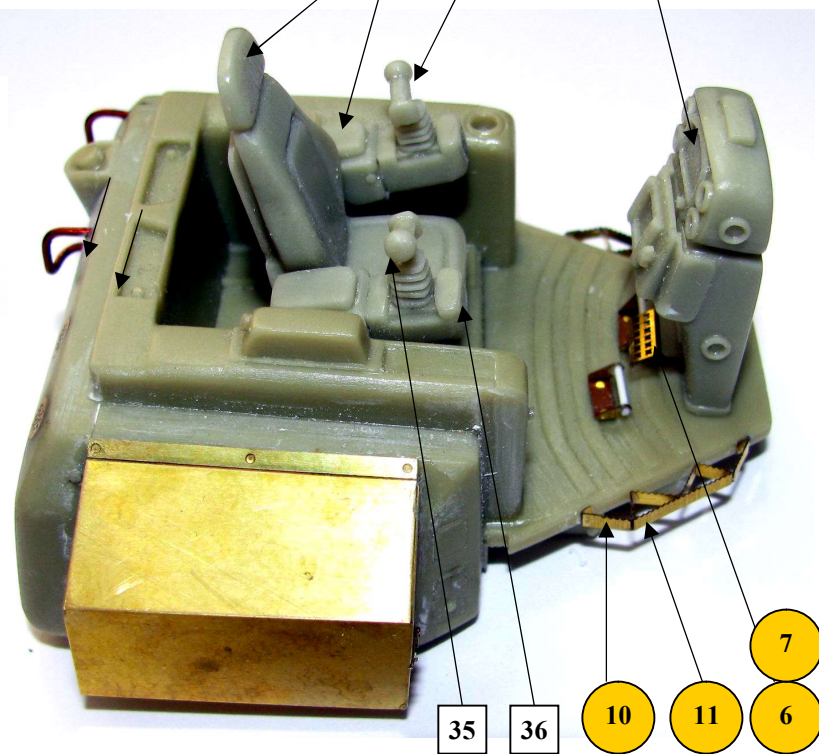

7

35

36

10

11

6

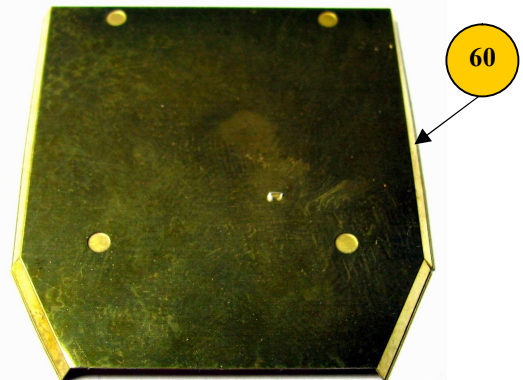
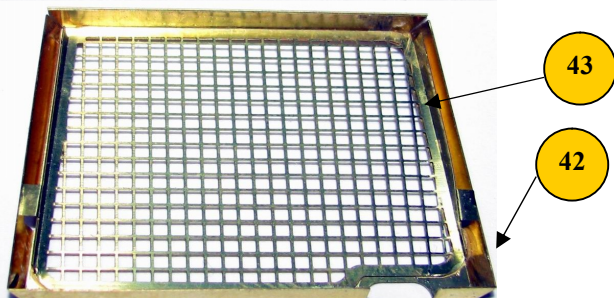
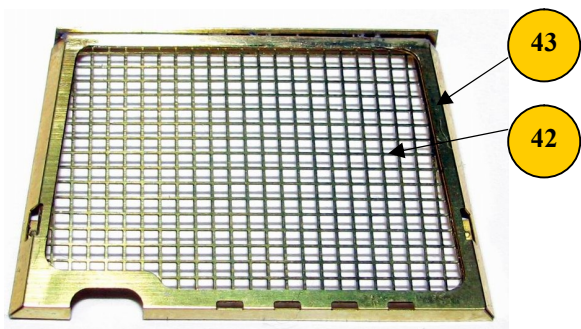
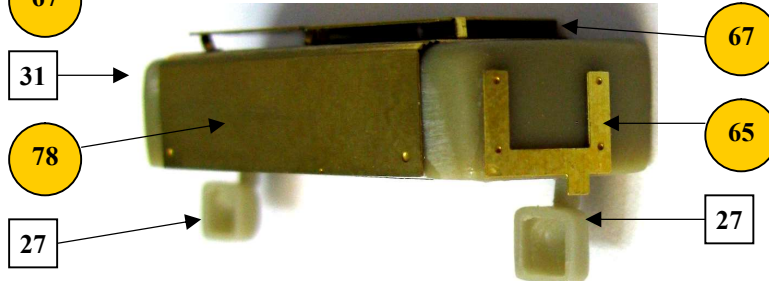
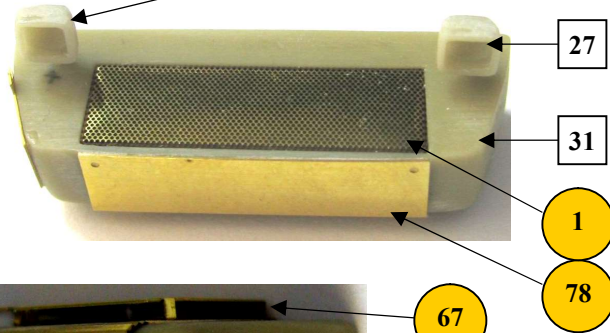
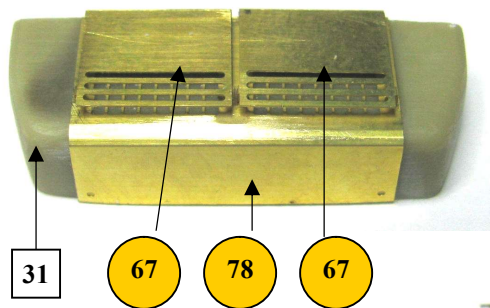
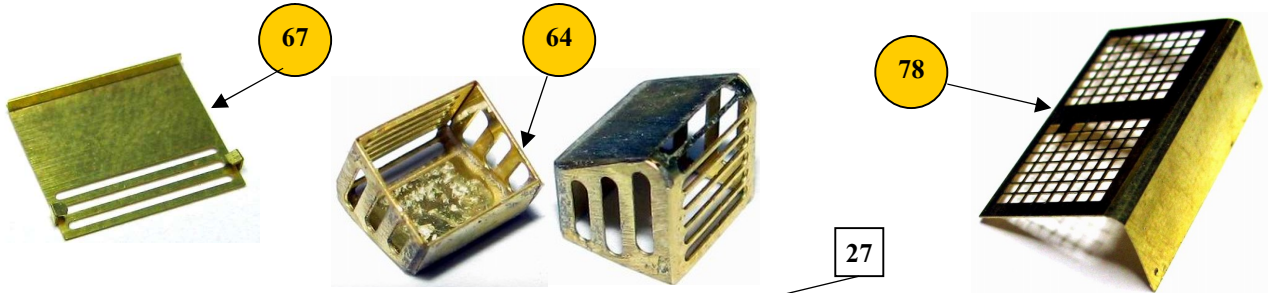
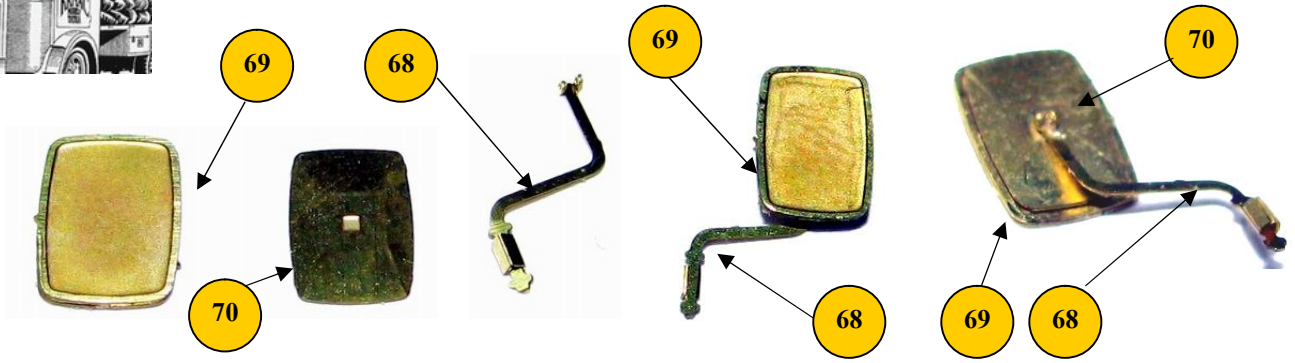

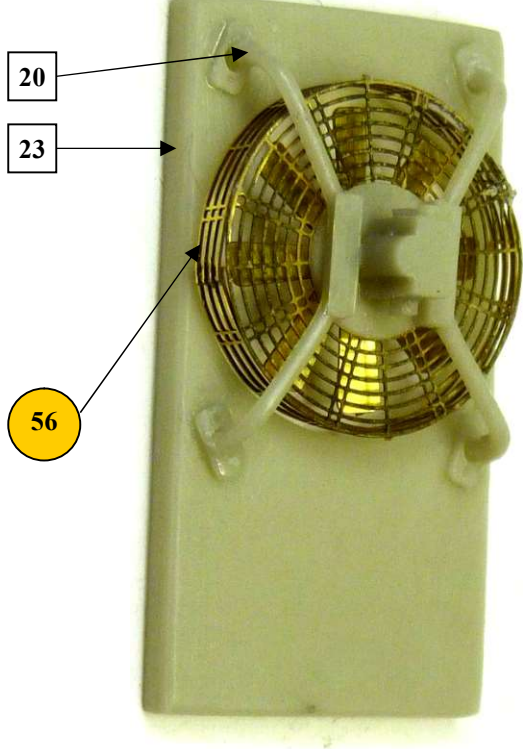
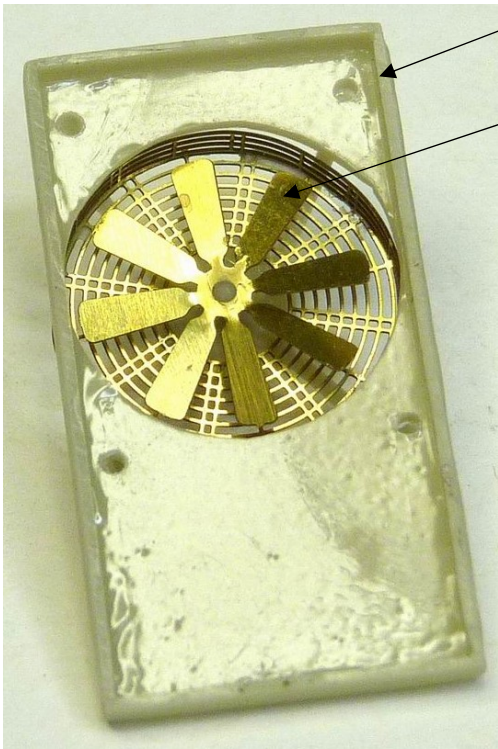
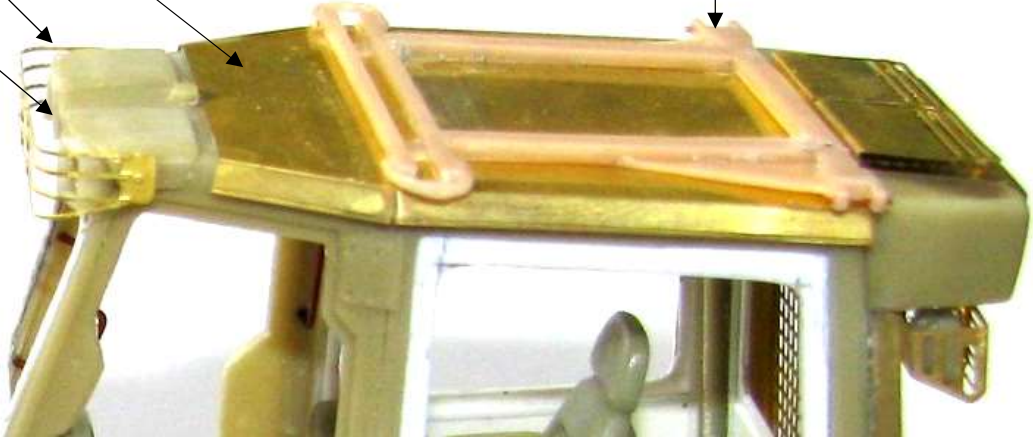
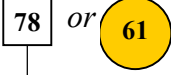
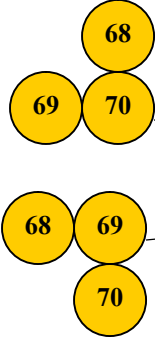
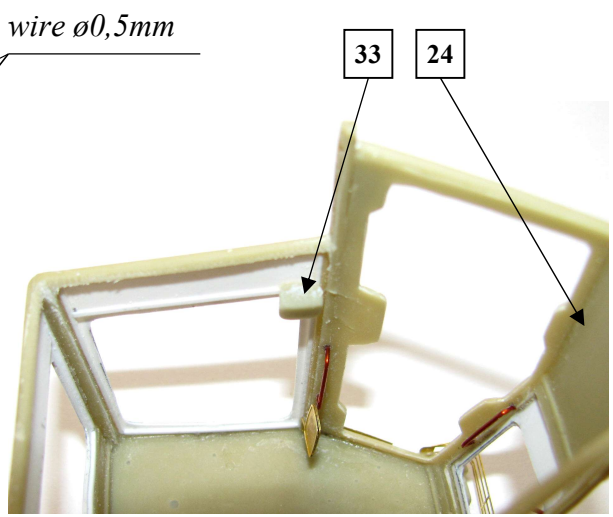
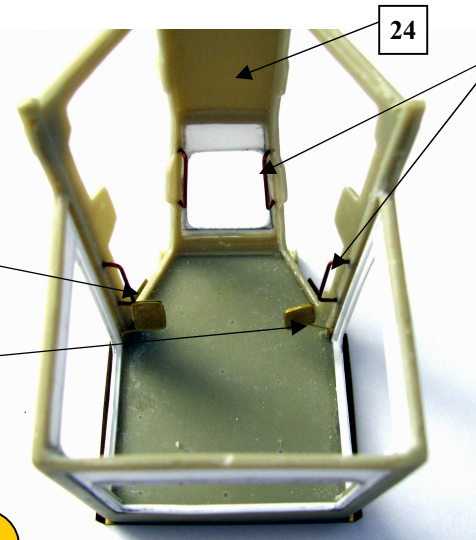

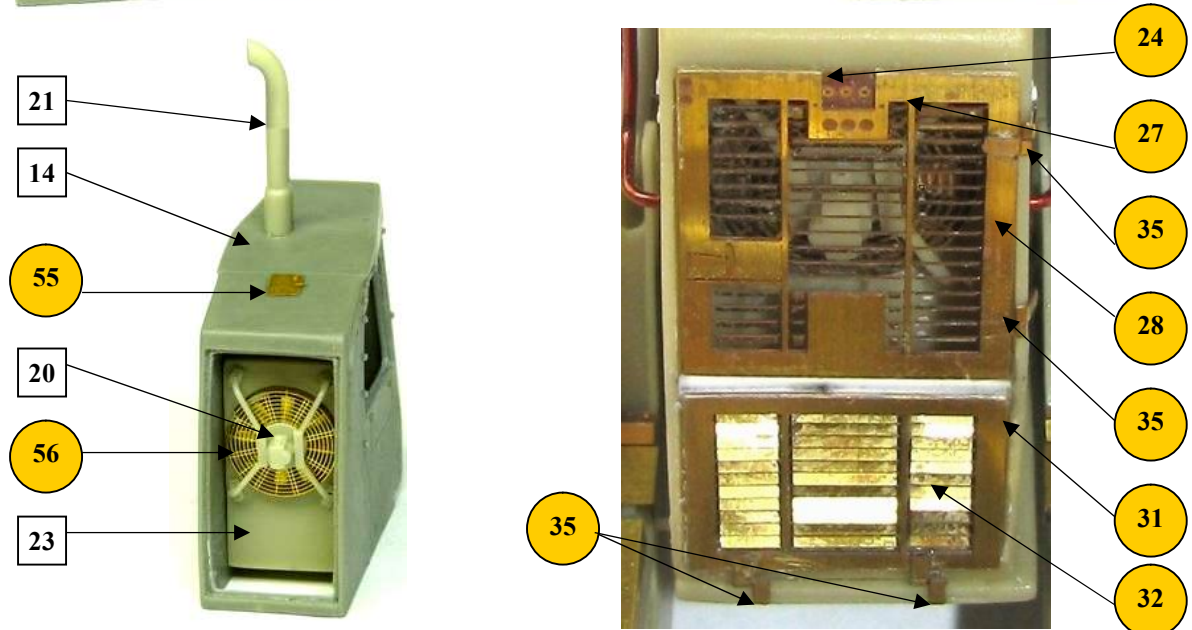
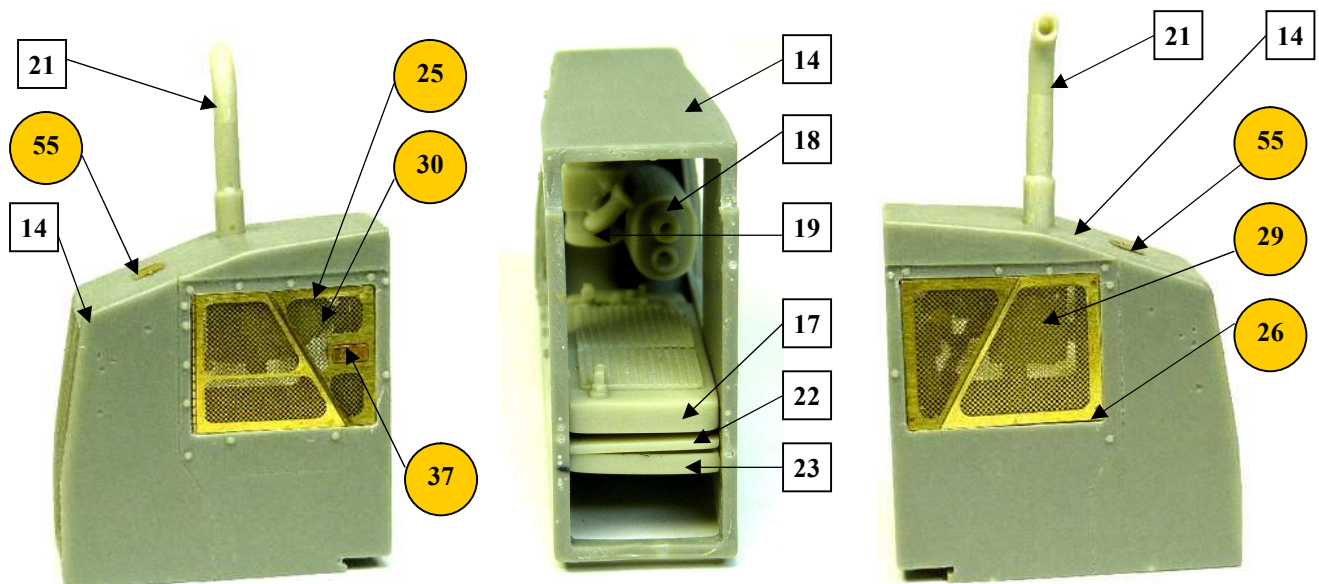
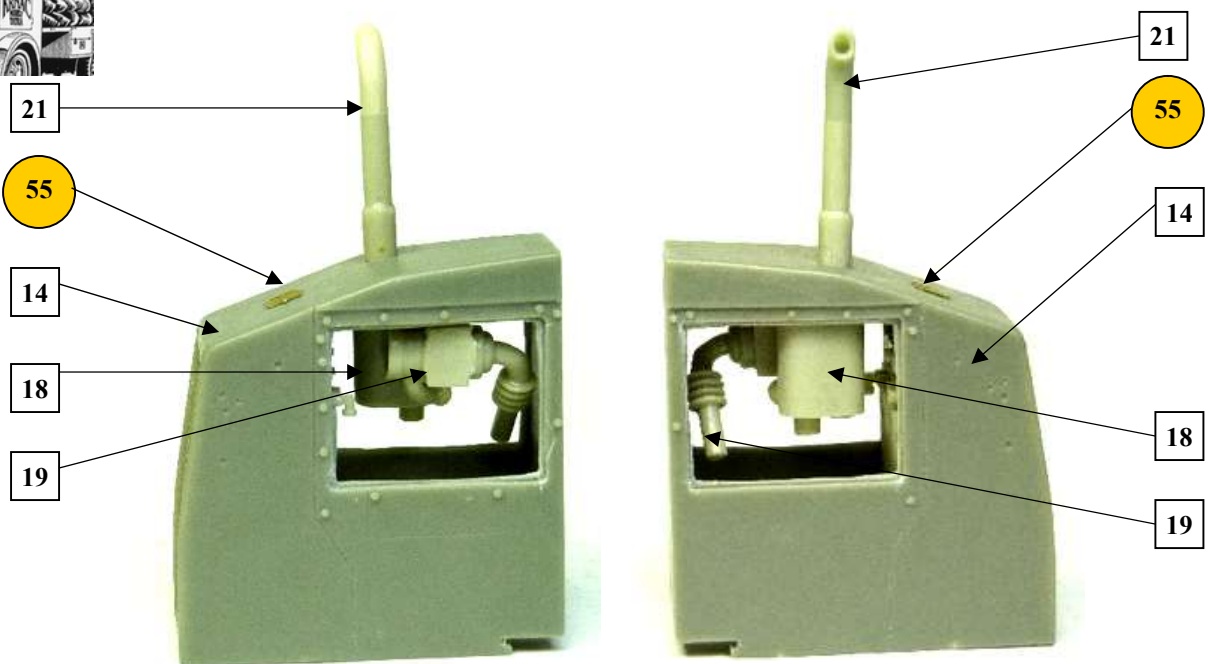

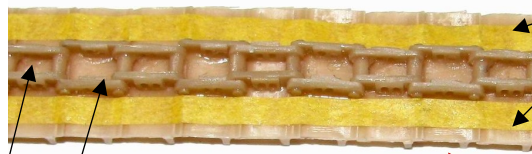
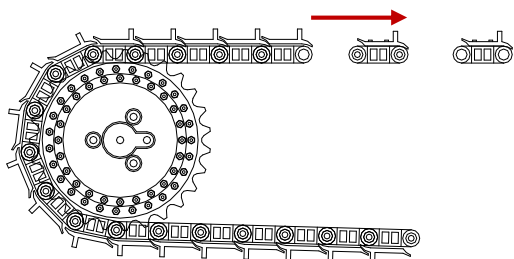
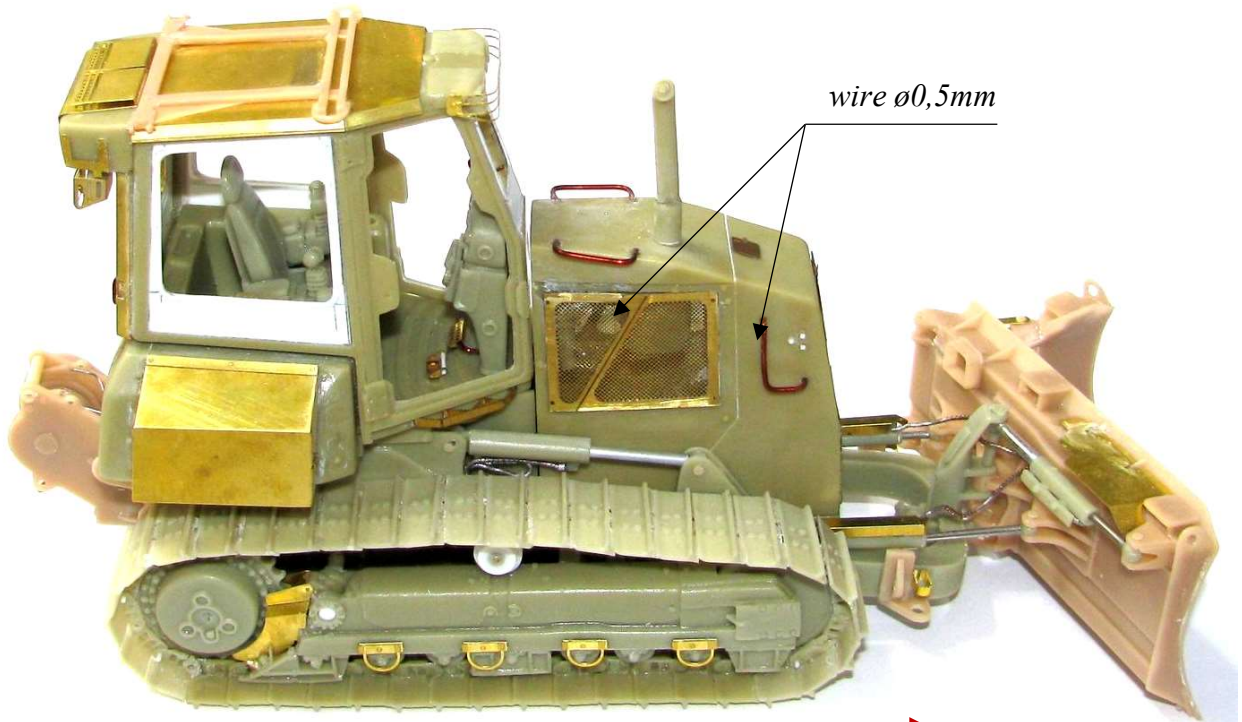
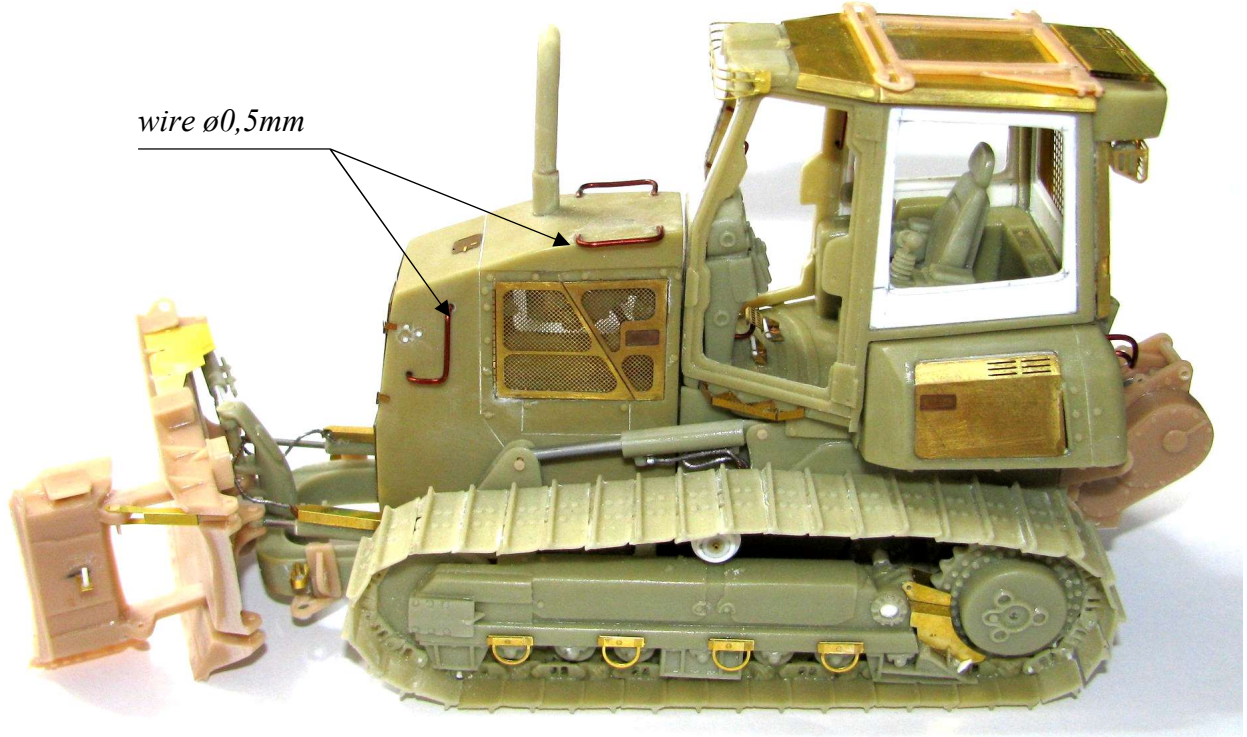

masking tape

66 67



D6K US military service 1/35

F3089

13/14

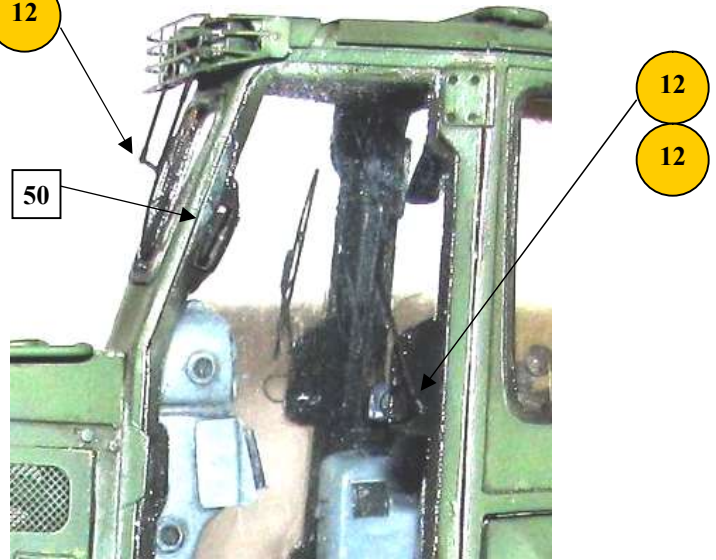
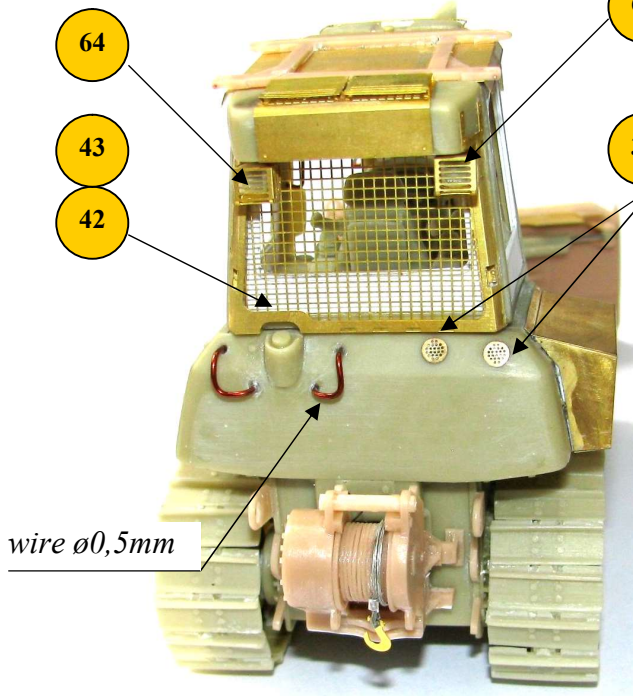

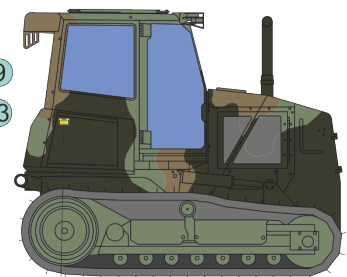
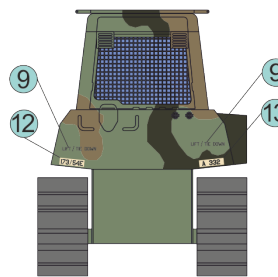
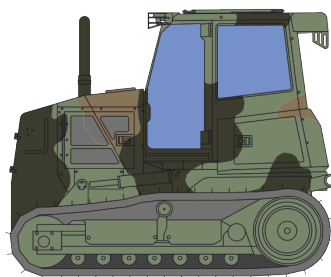
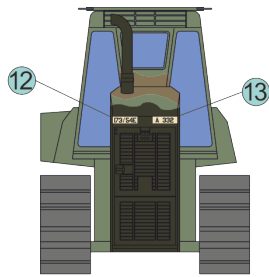

with Multi-Shank Ripper

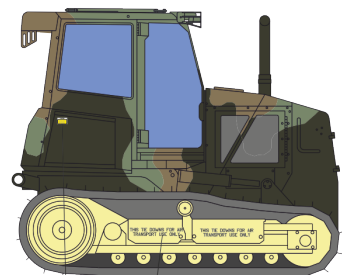
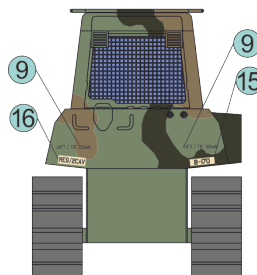
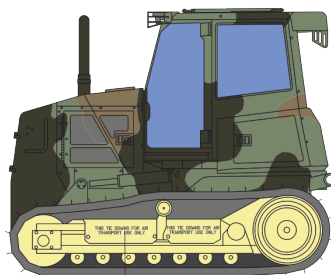
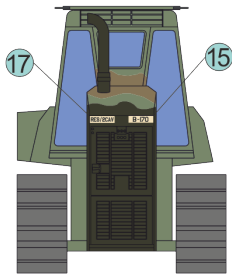

with Winch PA50

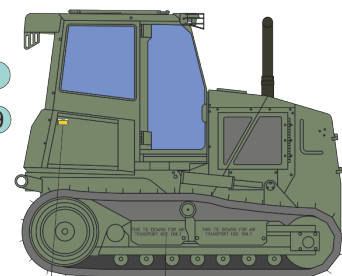
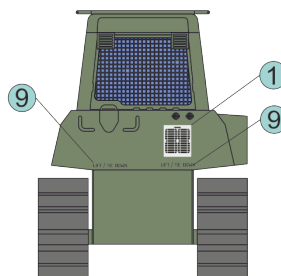
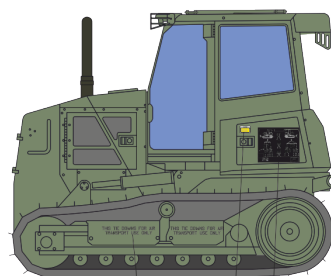
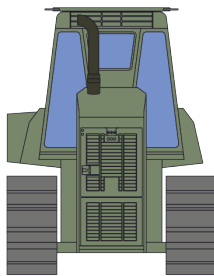

with Winch PA50 or Multi-Shank Ripper

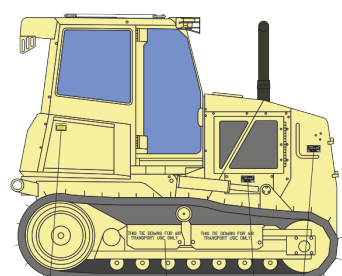
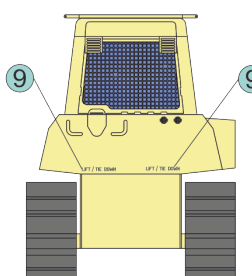
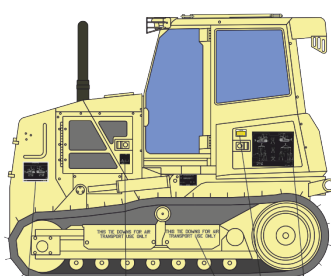
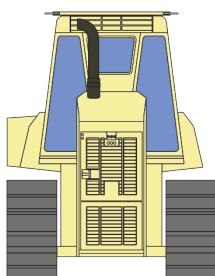

with Winch PA50 or Multi-Shank Ripper

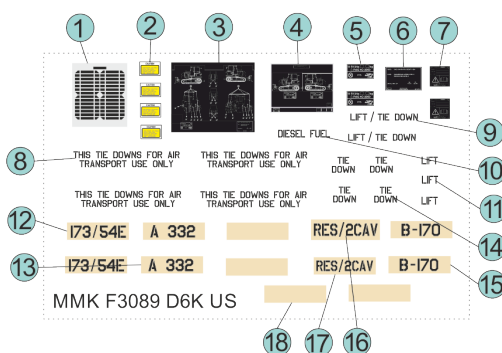

Attention !
Decals need to be cut. They are connected with a layer of lacquer.
Pozor !
Obtisky je nutné oříznout. Jsou spojené vrstvou laku.