

FAST II
RESIN PARTS

1/35
1/20

návod

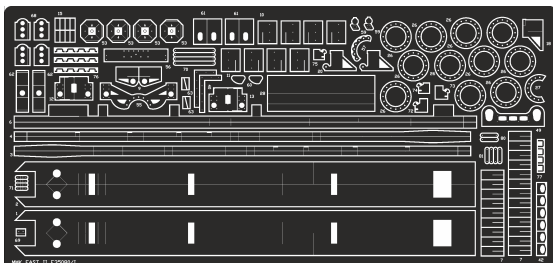
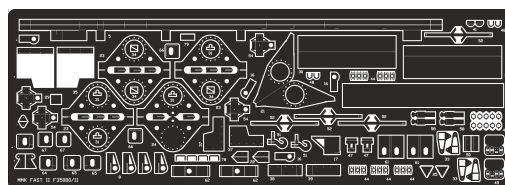
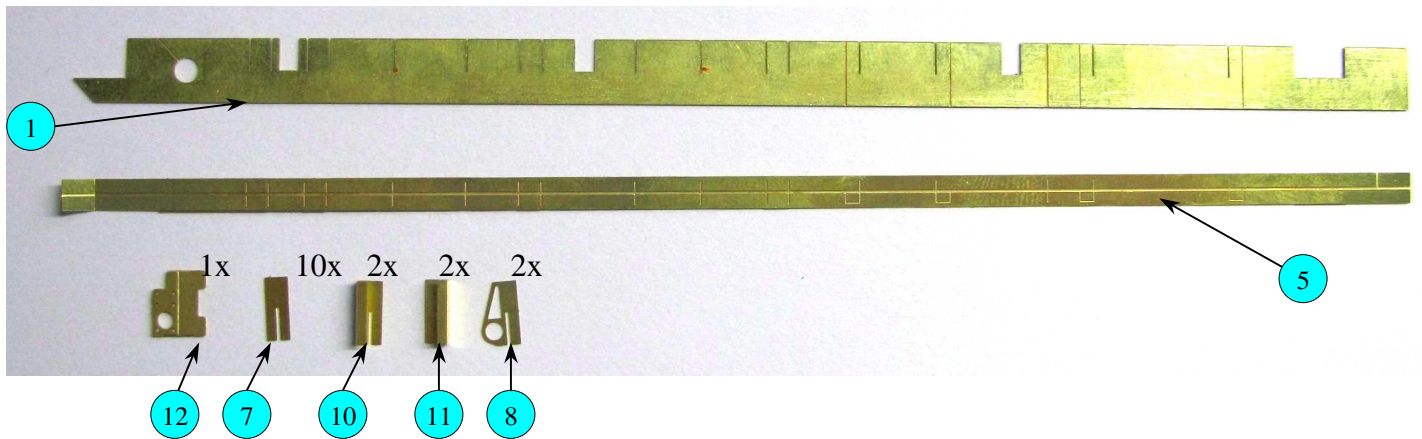
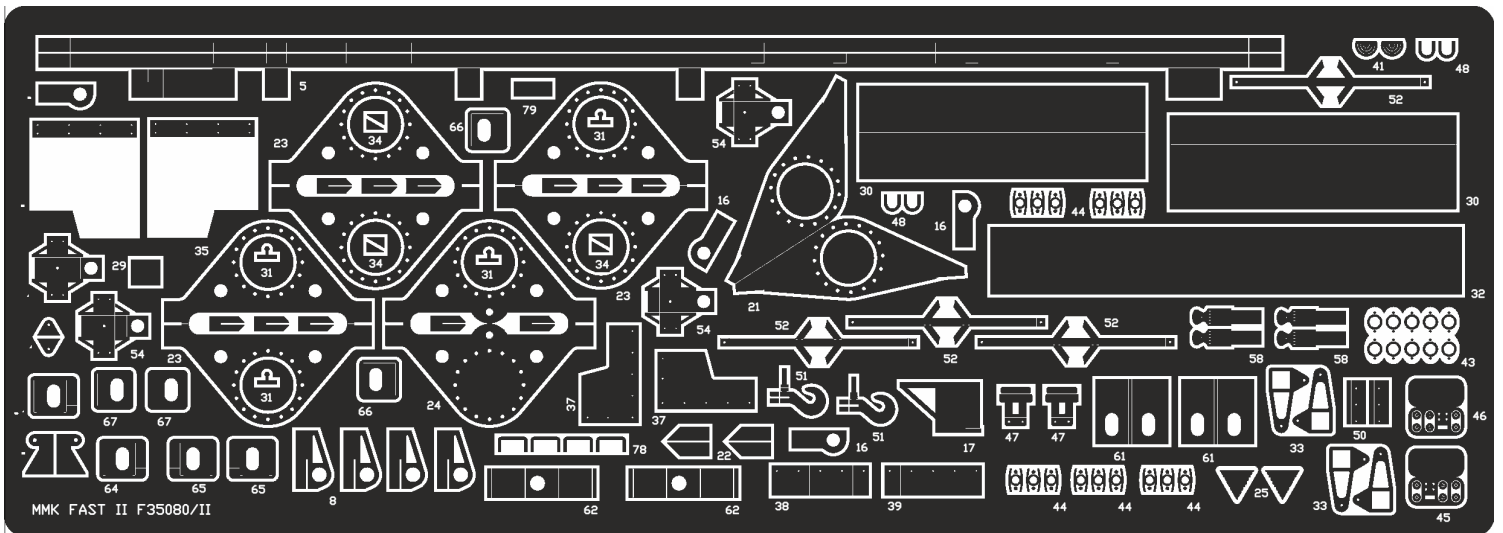
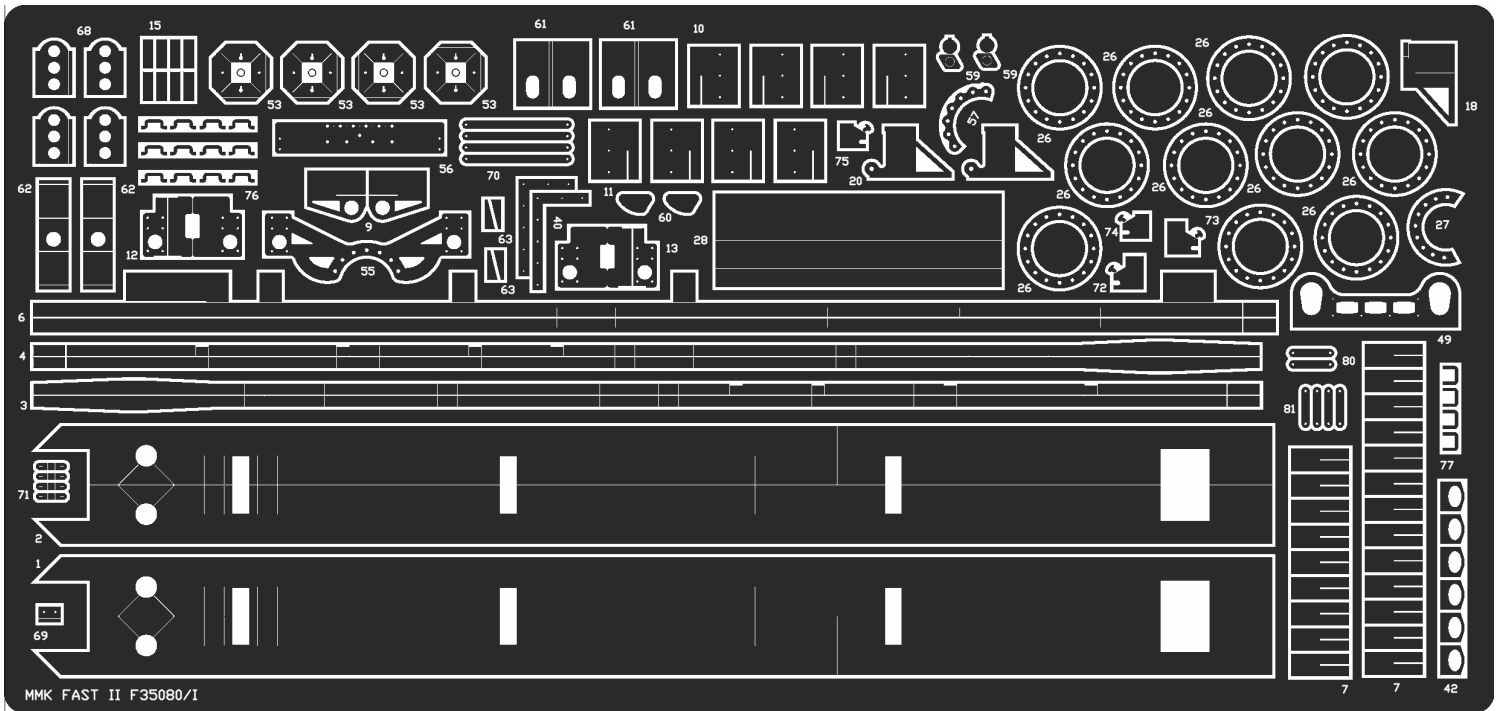
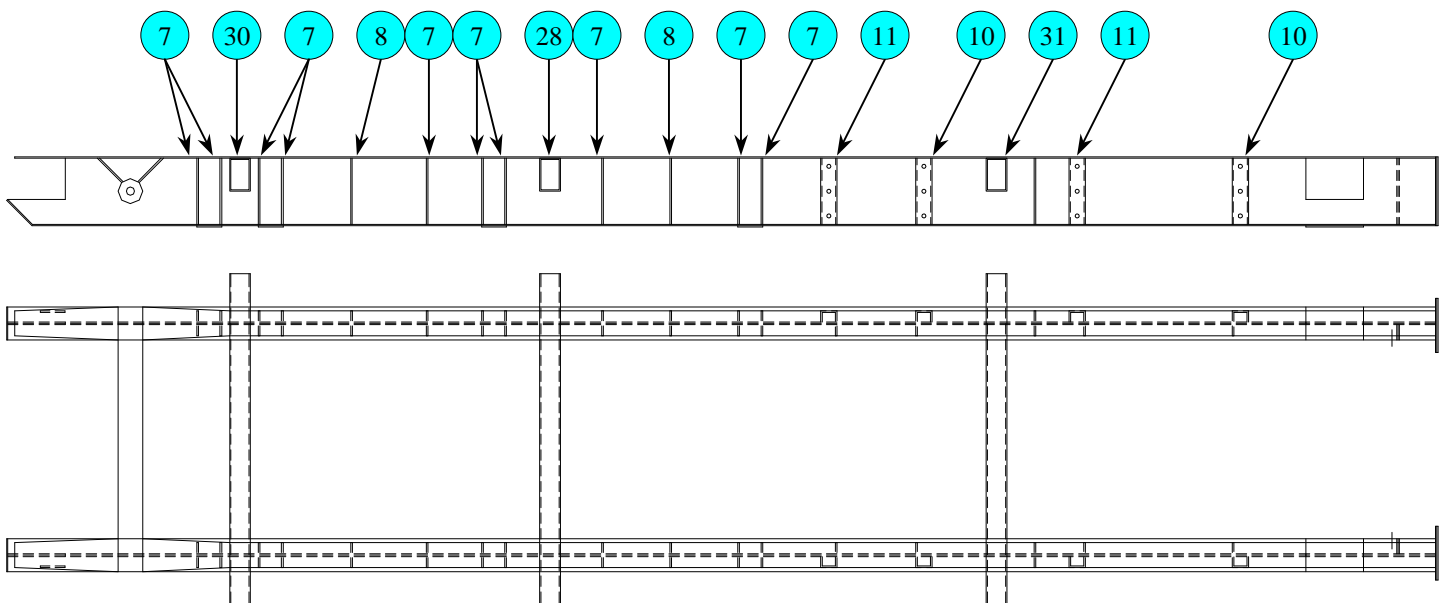
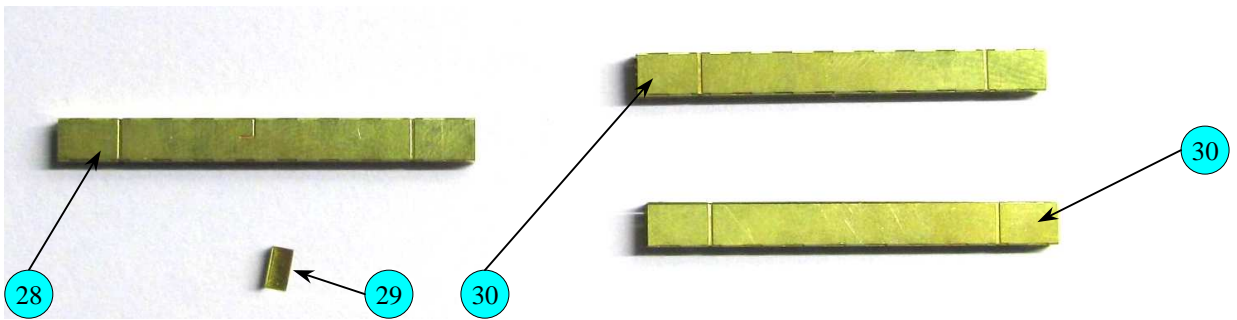
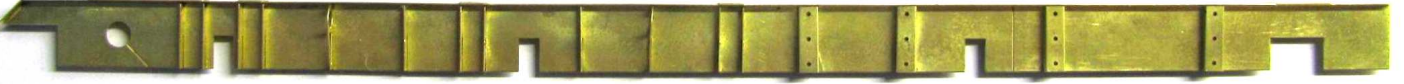
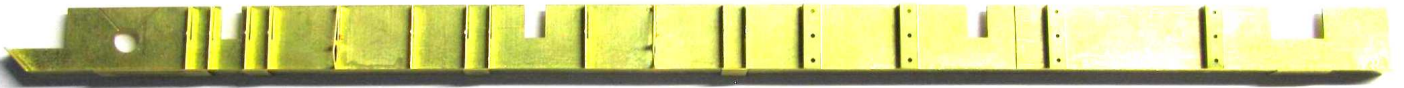

PHOTO-ETCHED PARTS







FAST II

1/35
4/20

návod

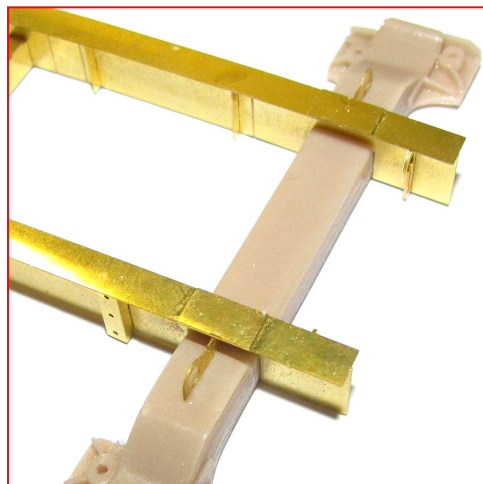
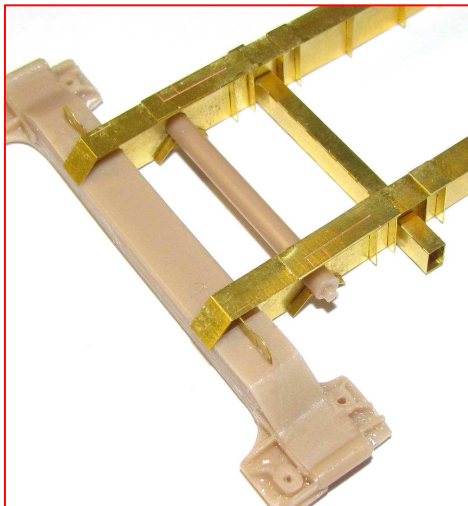
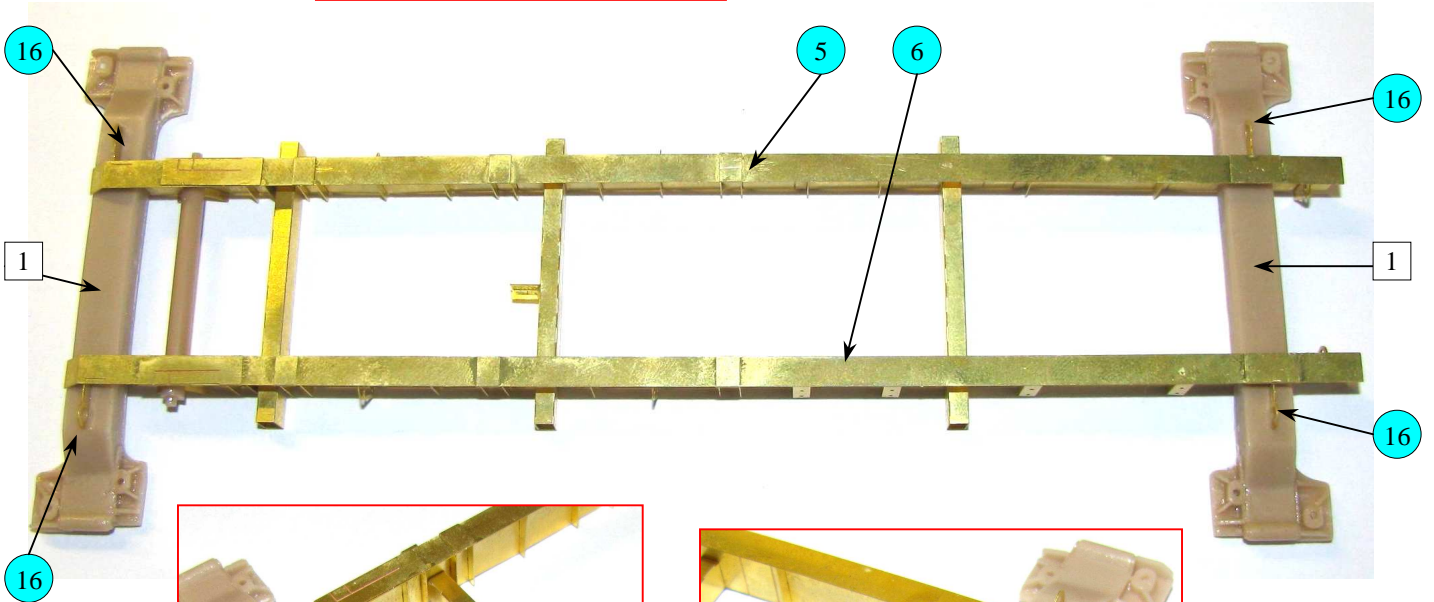
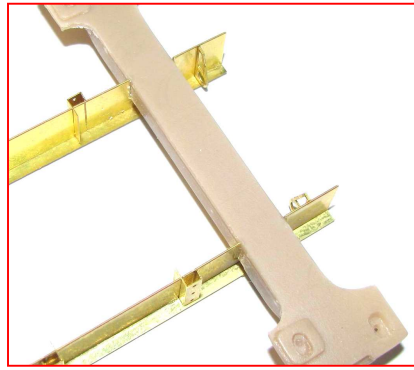
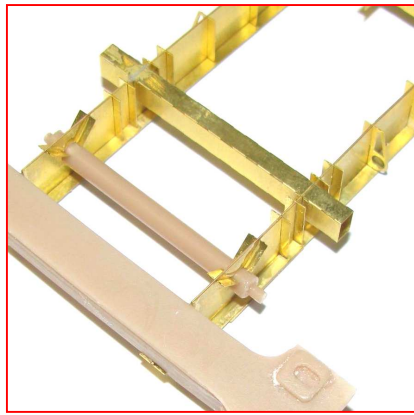
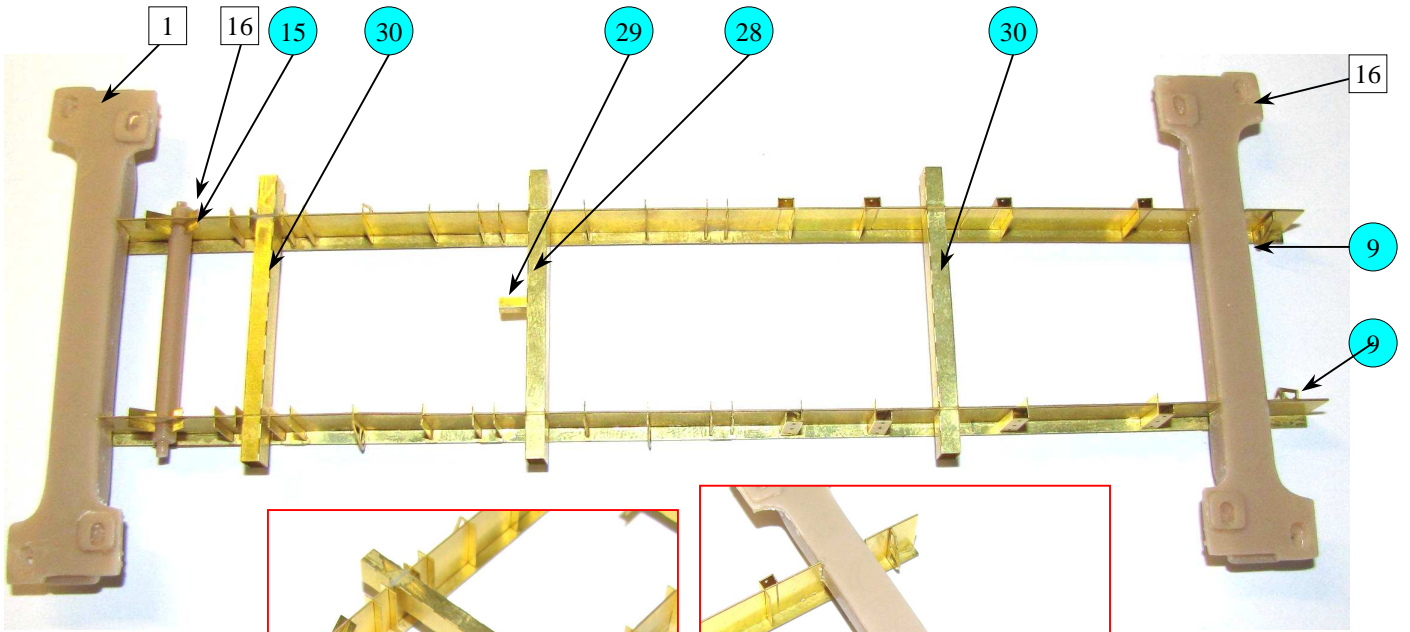

FAST II

1/35
5/20

návod

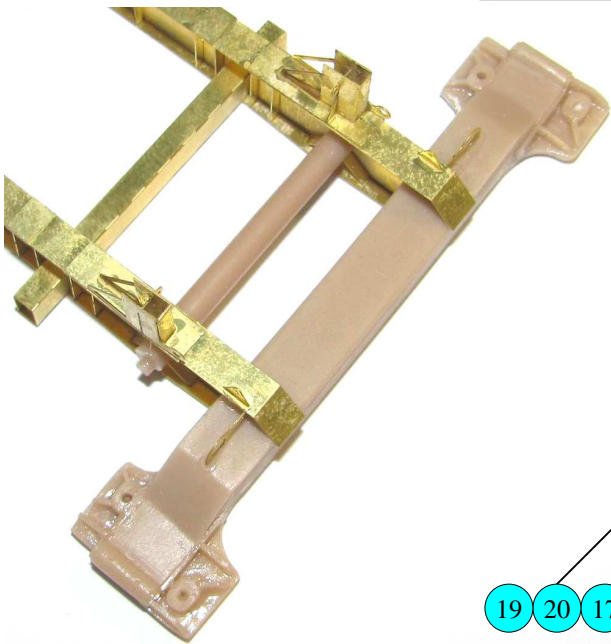
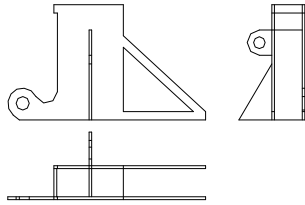
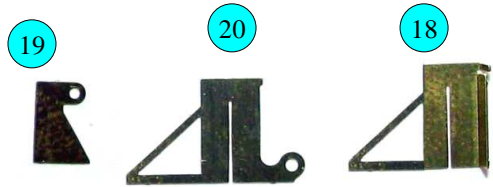
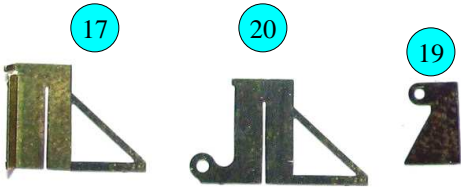

19 20 17

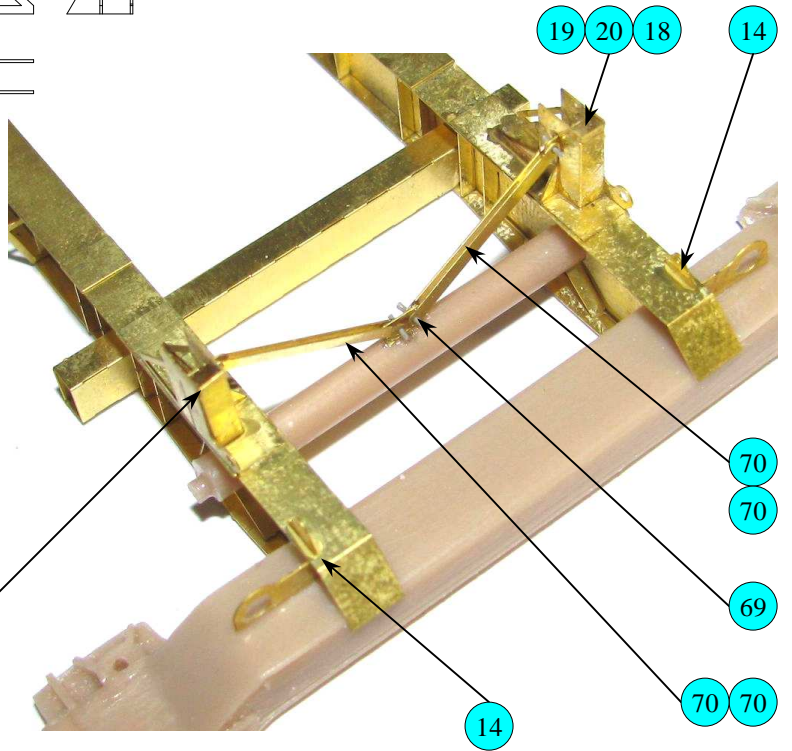

19 20 18 14

70

70

69

14

70 70

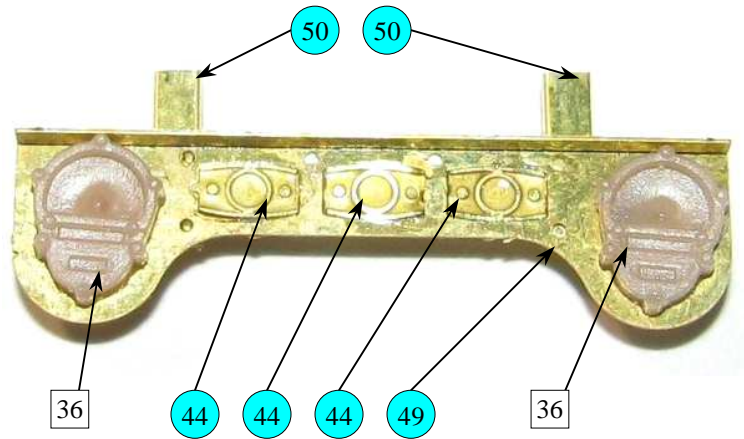
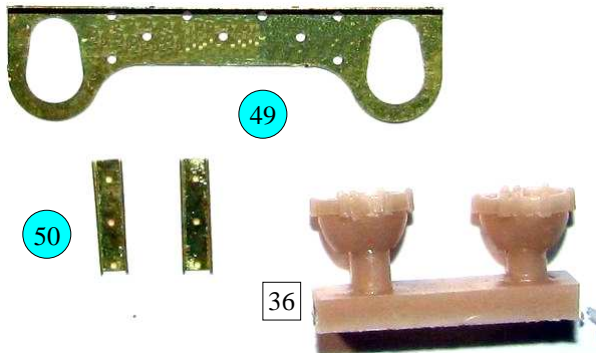

50 50

36

44

44

44

49

36



3

4

A

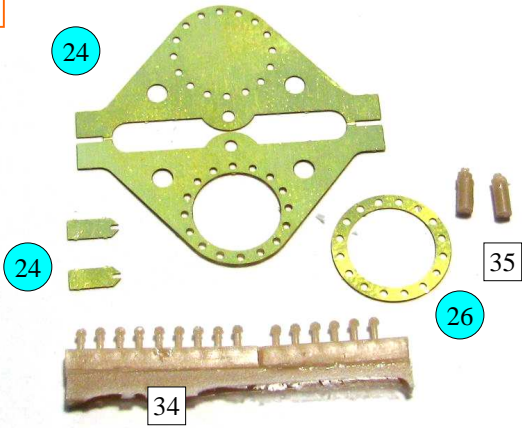

B

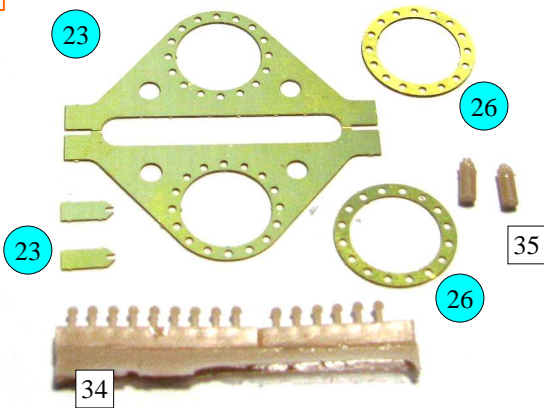

C

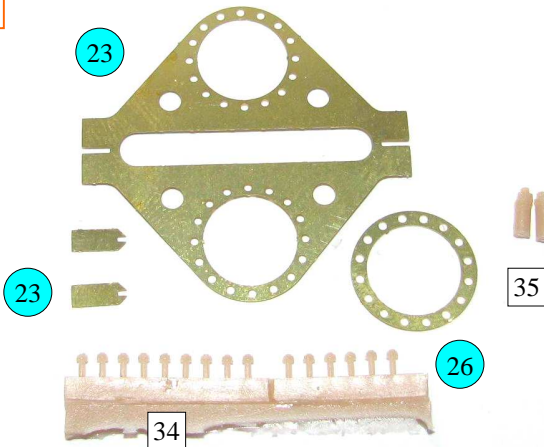

D

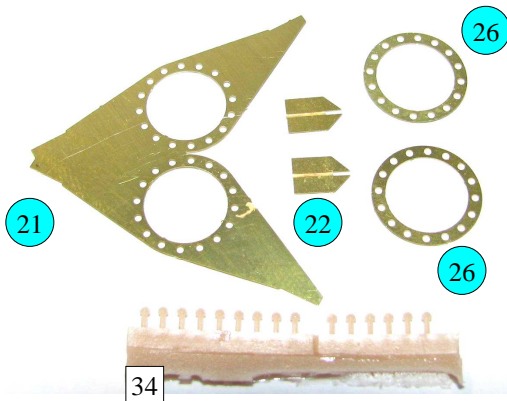

E



F

3x



G

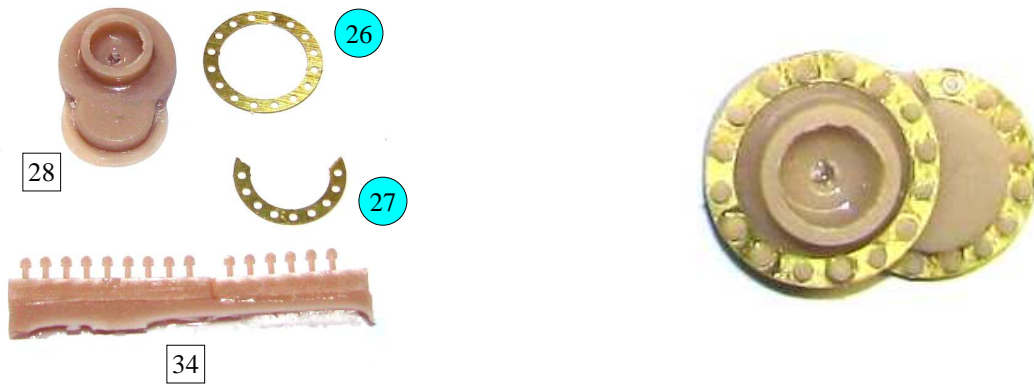

H



FAST II

**1/35
8/20**

návod

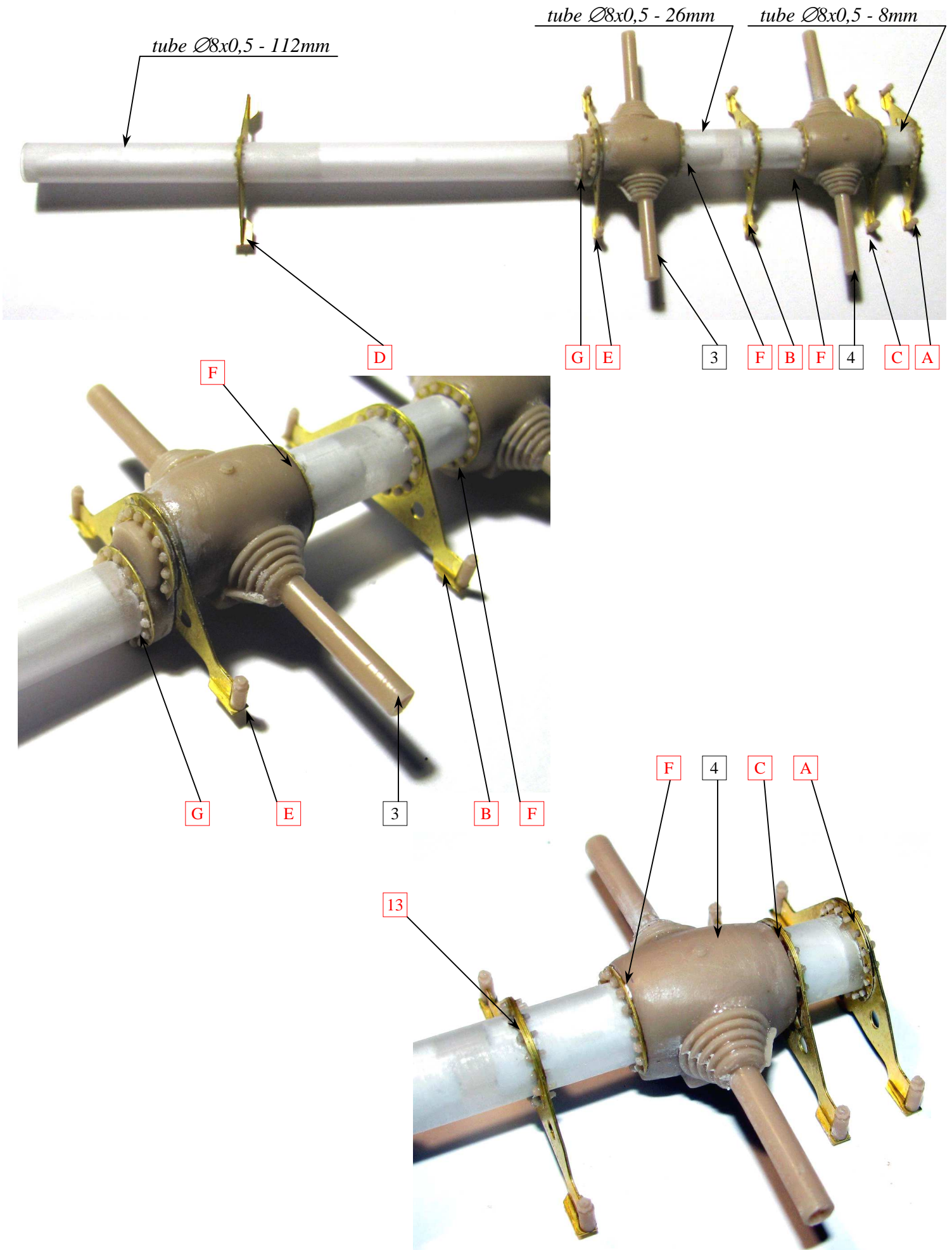

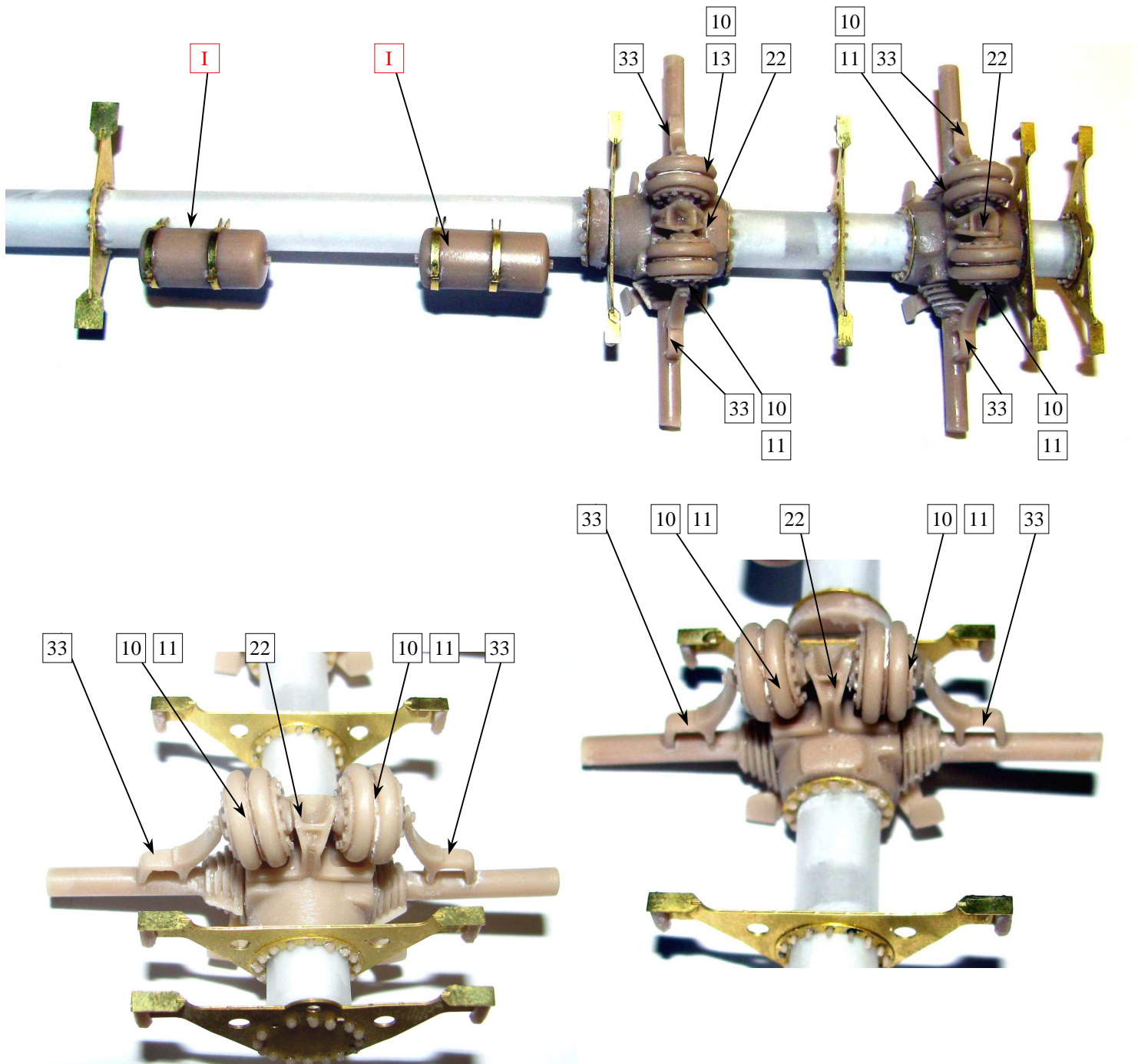
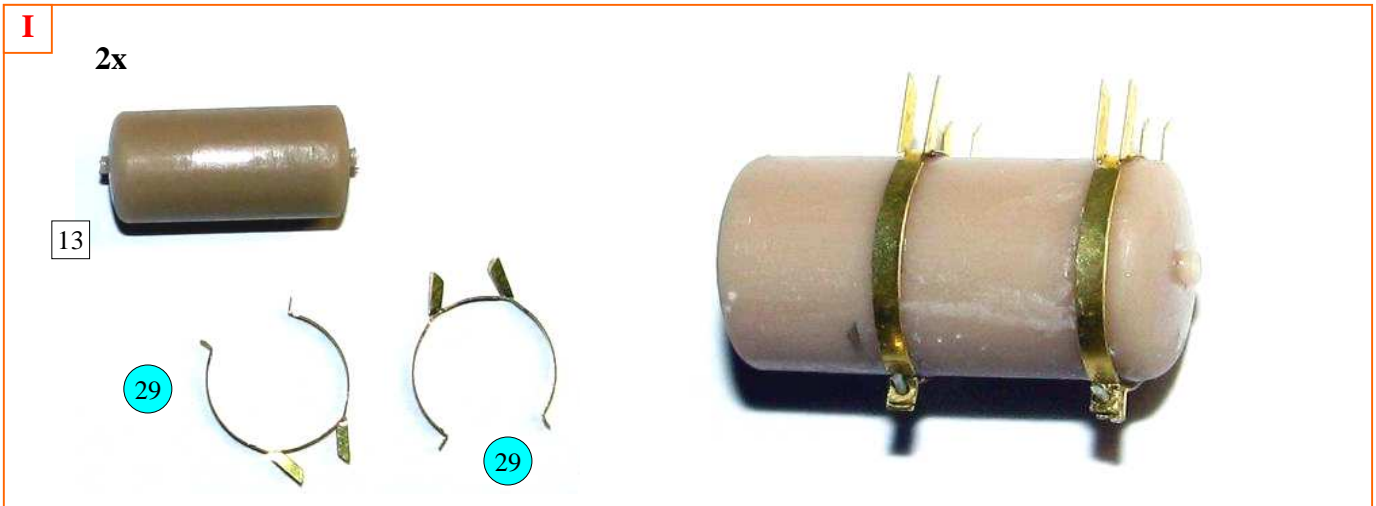

FAST II

1/35
10/20

návod

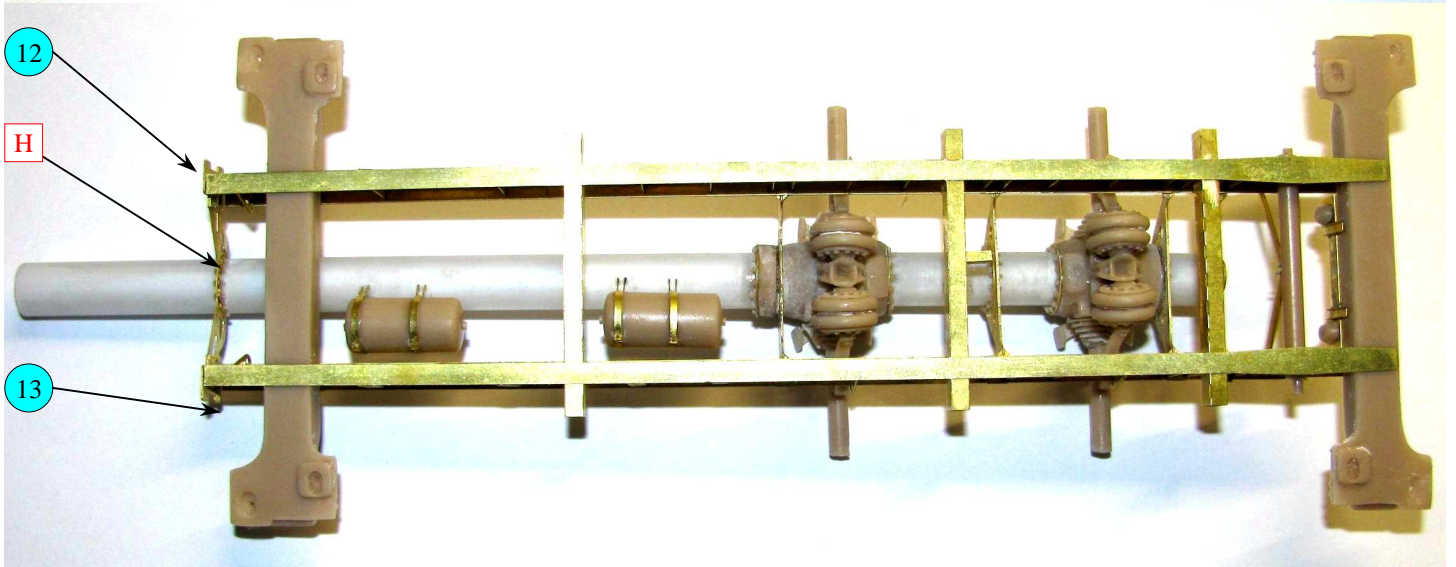
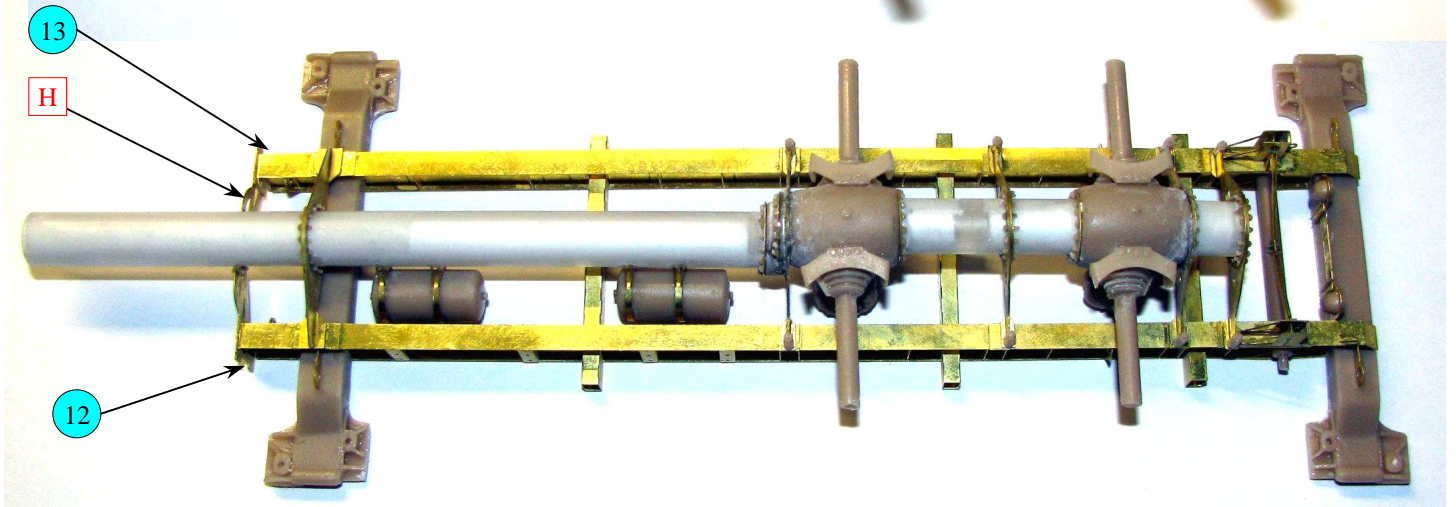
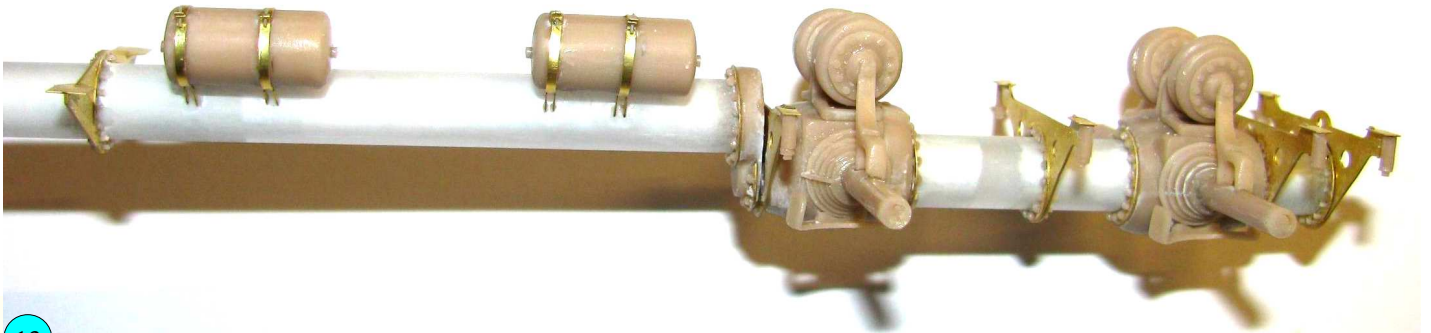
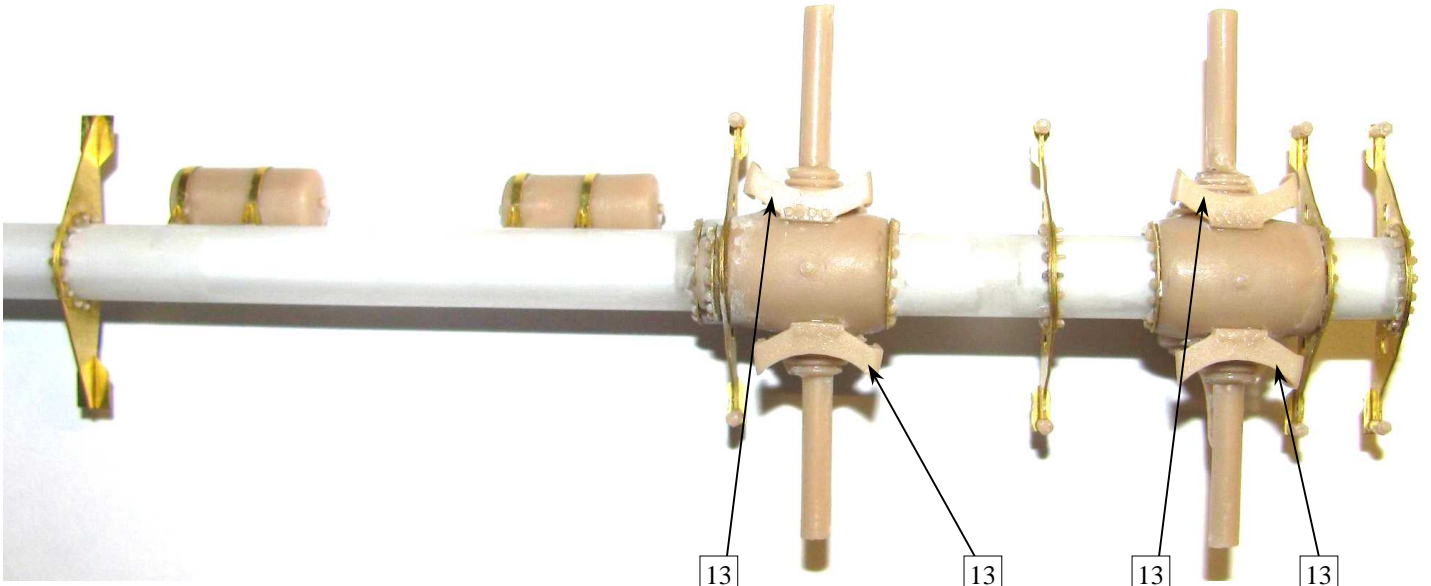

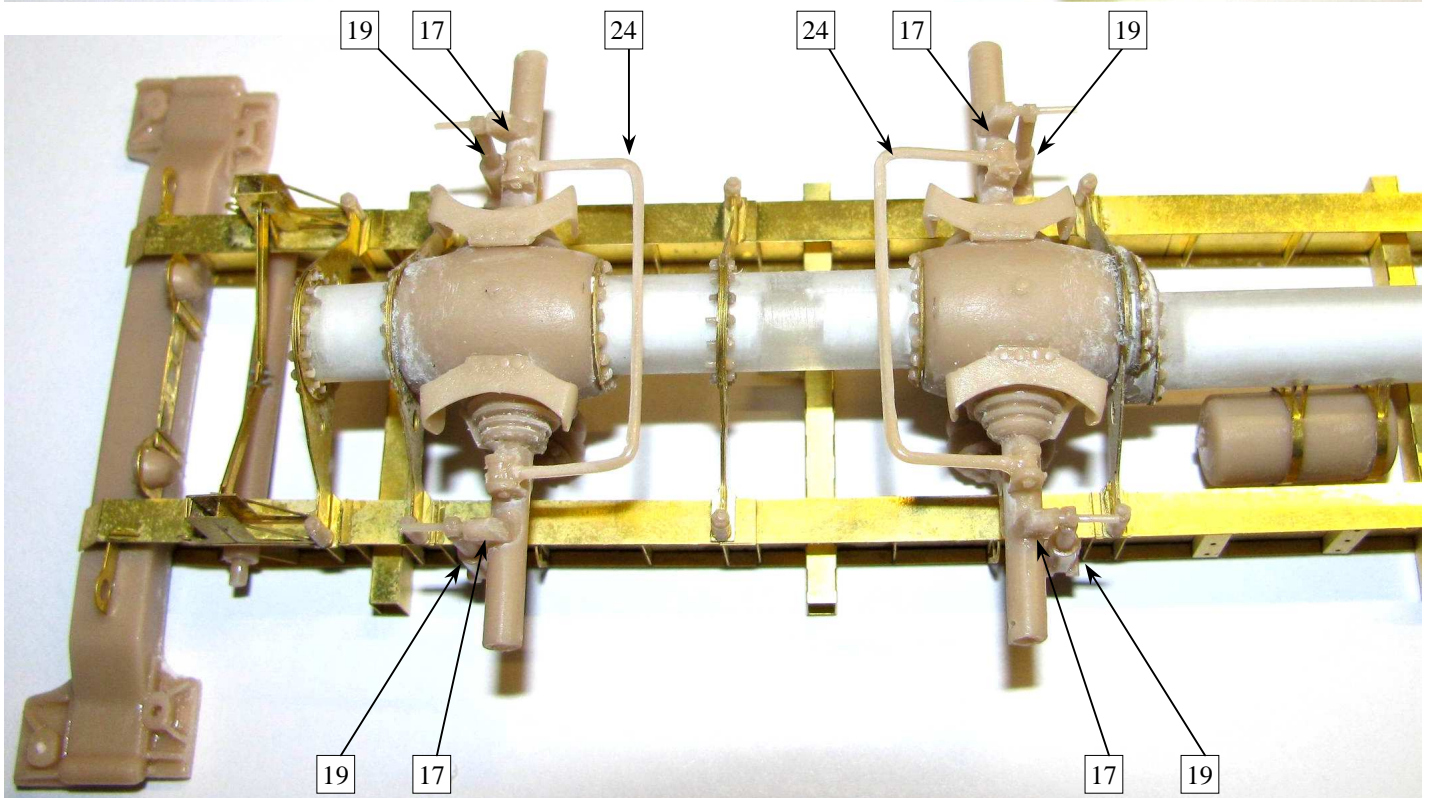
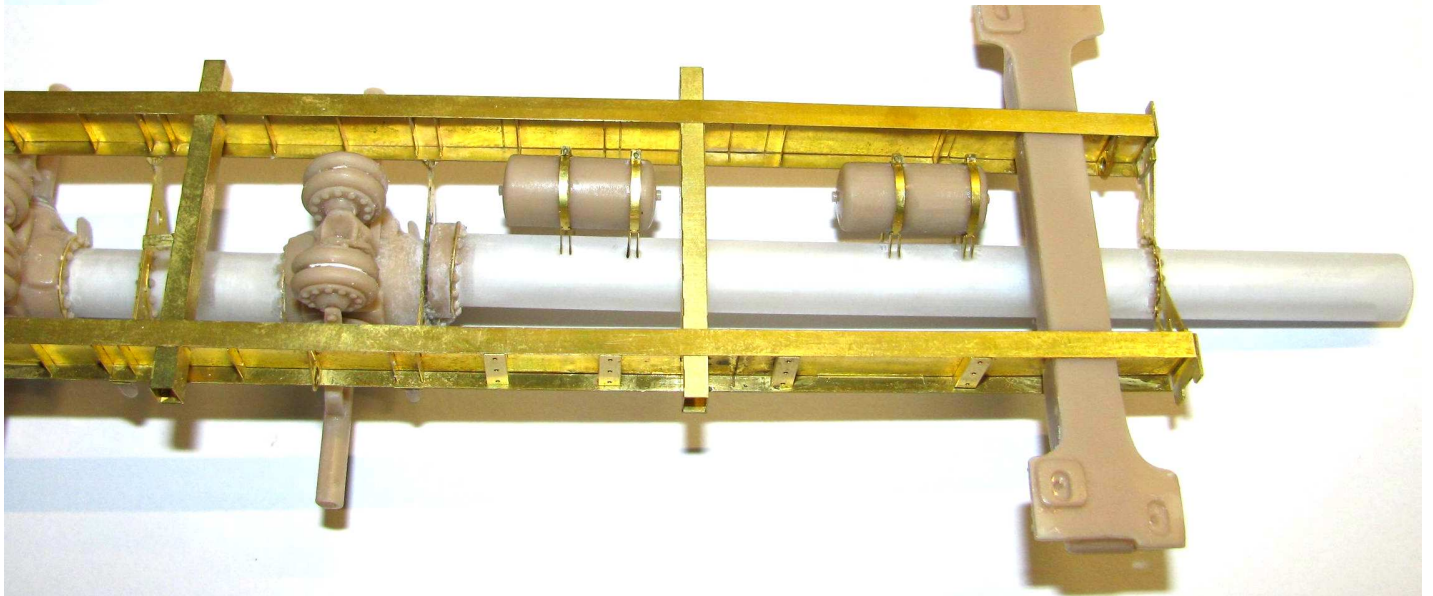
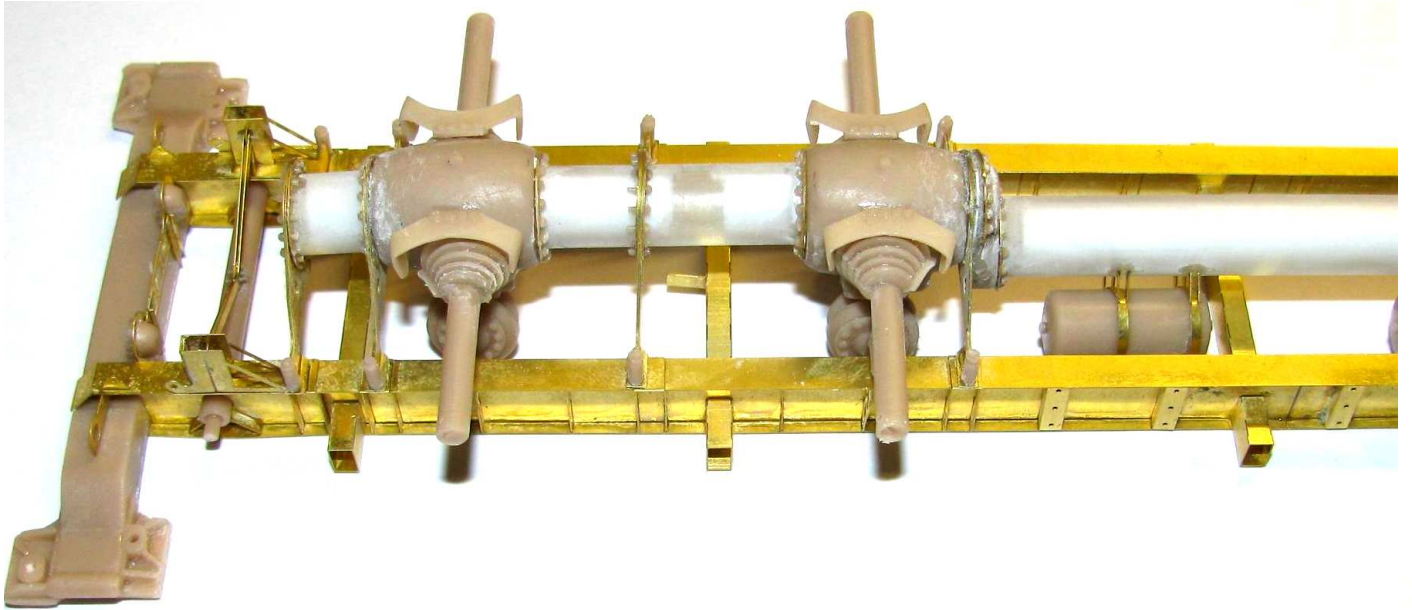

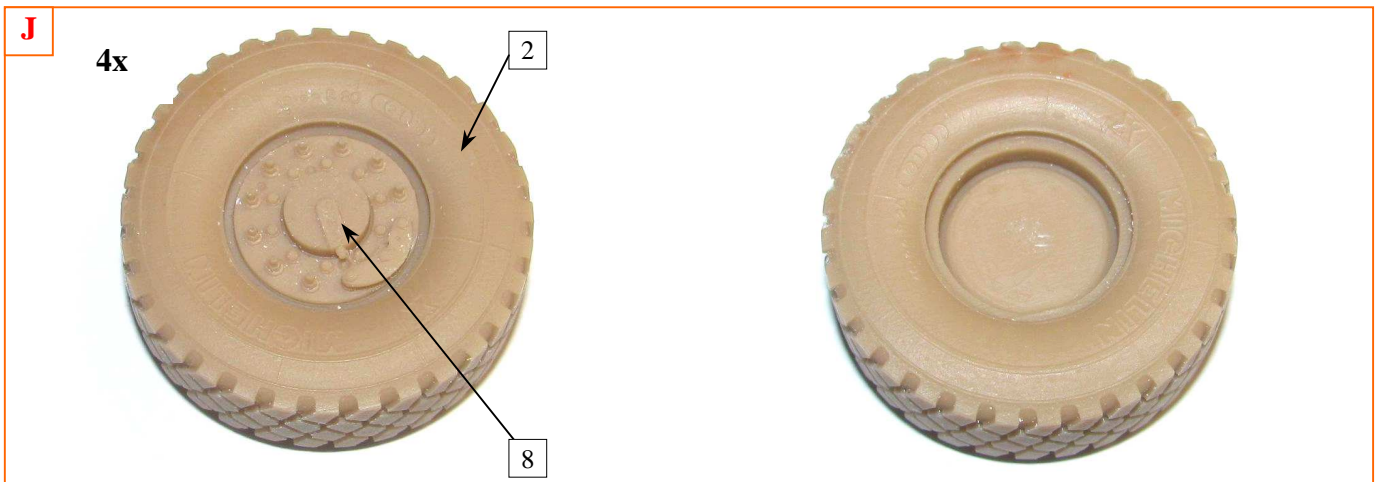
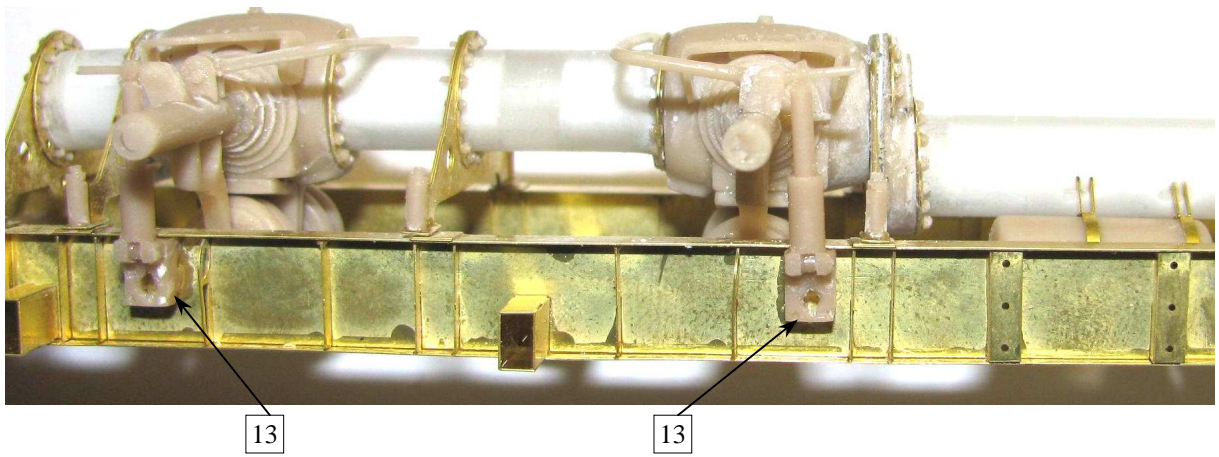
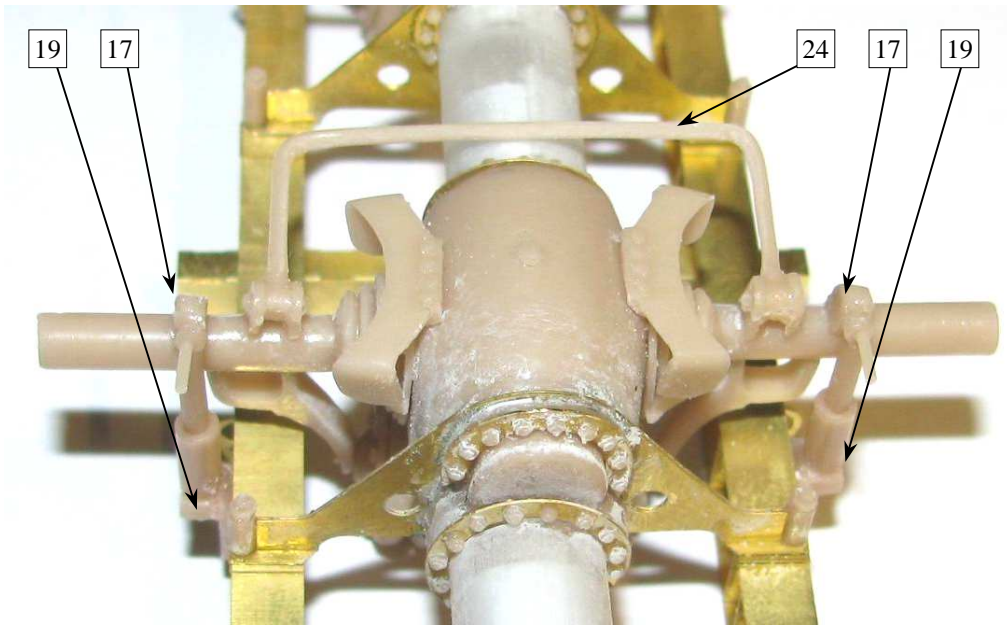

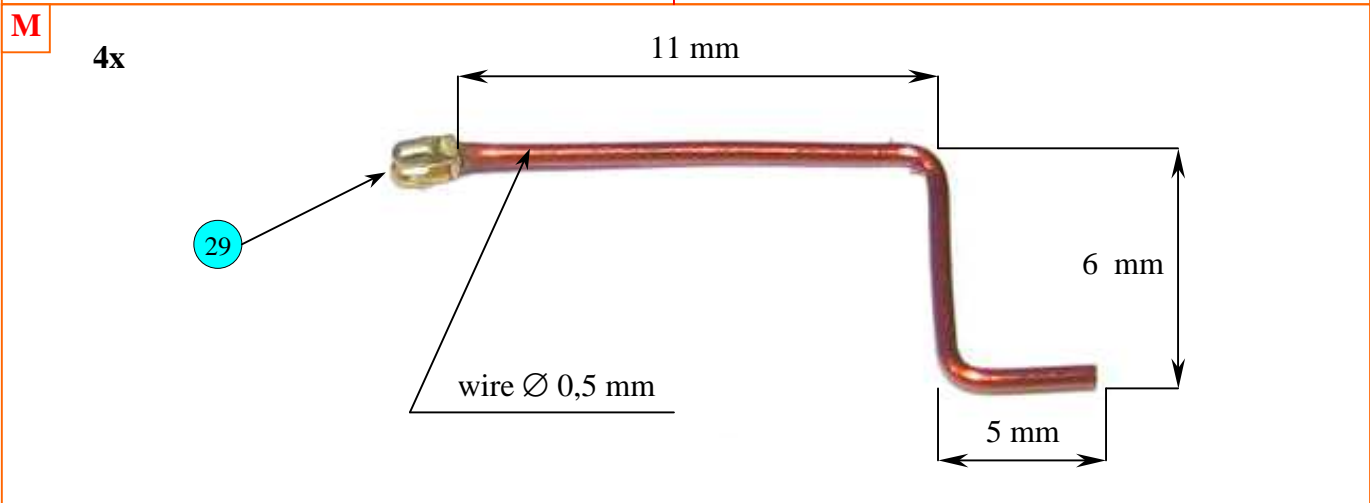
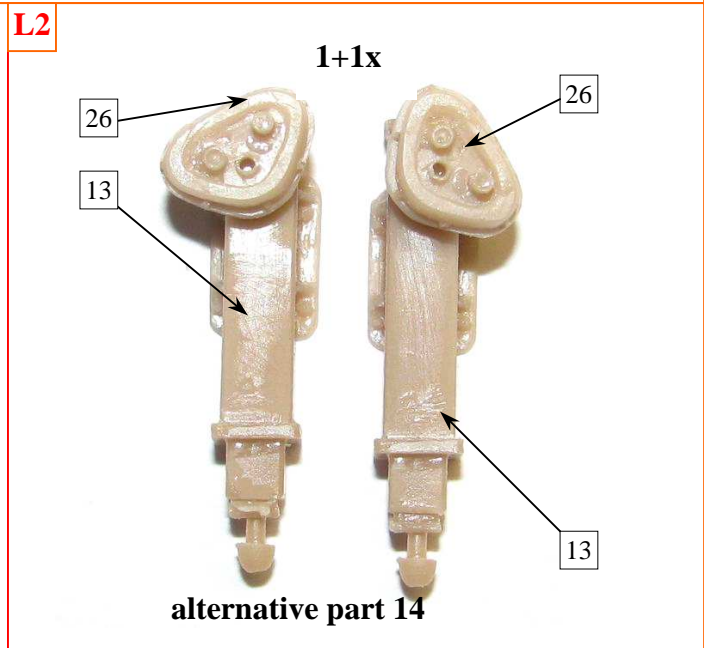
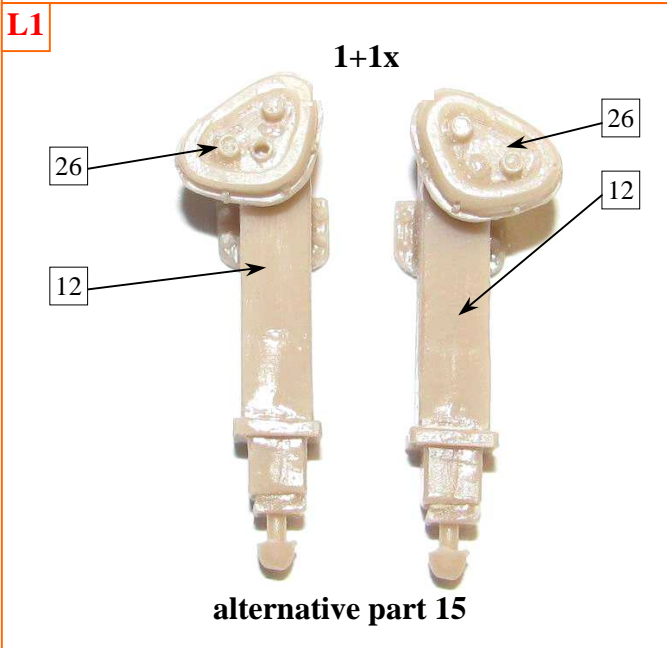
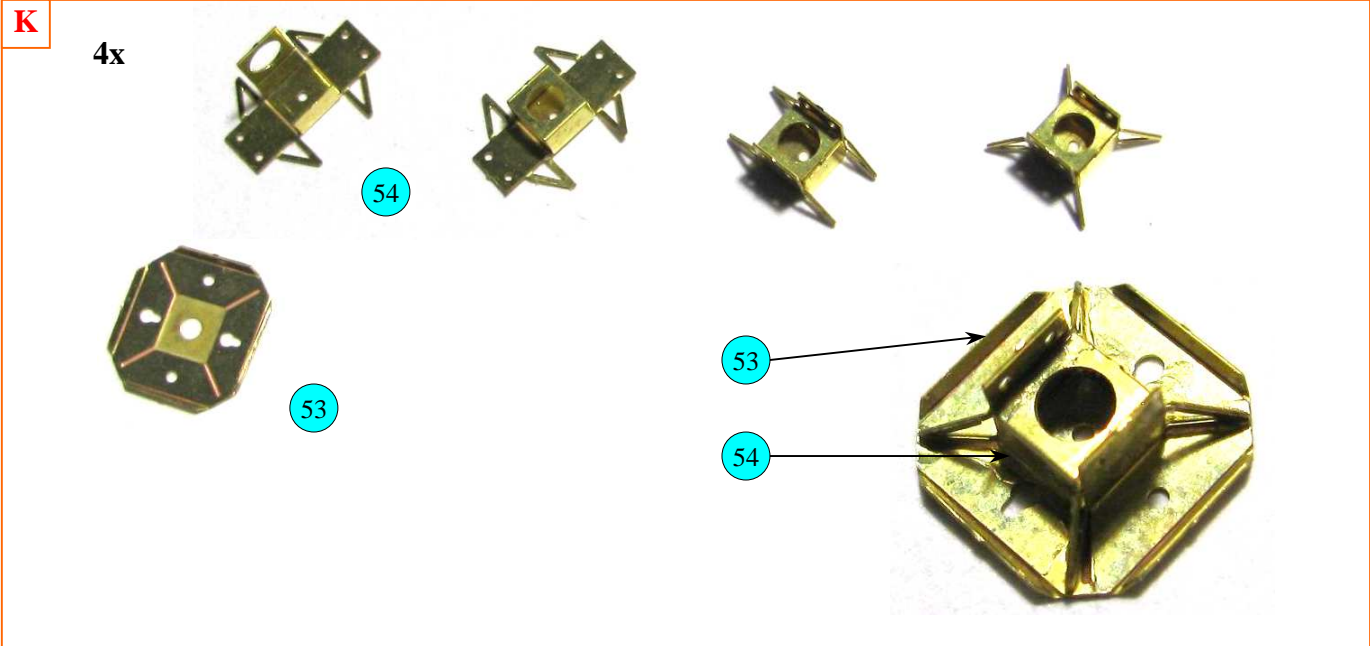

N

2x

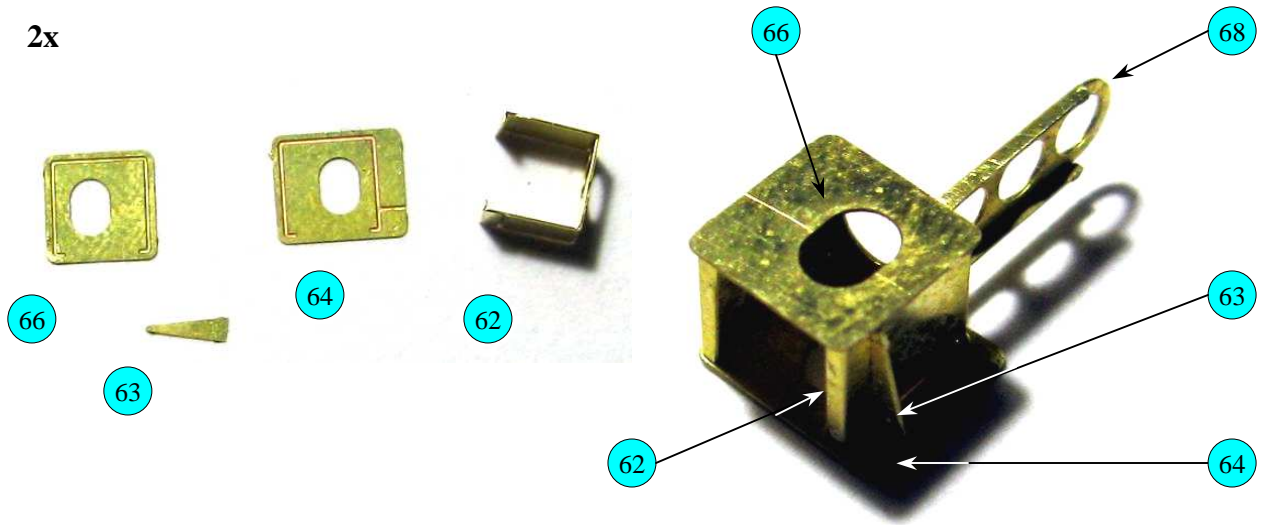

O

2x

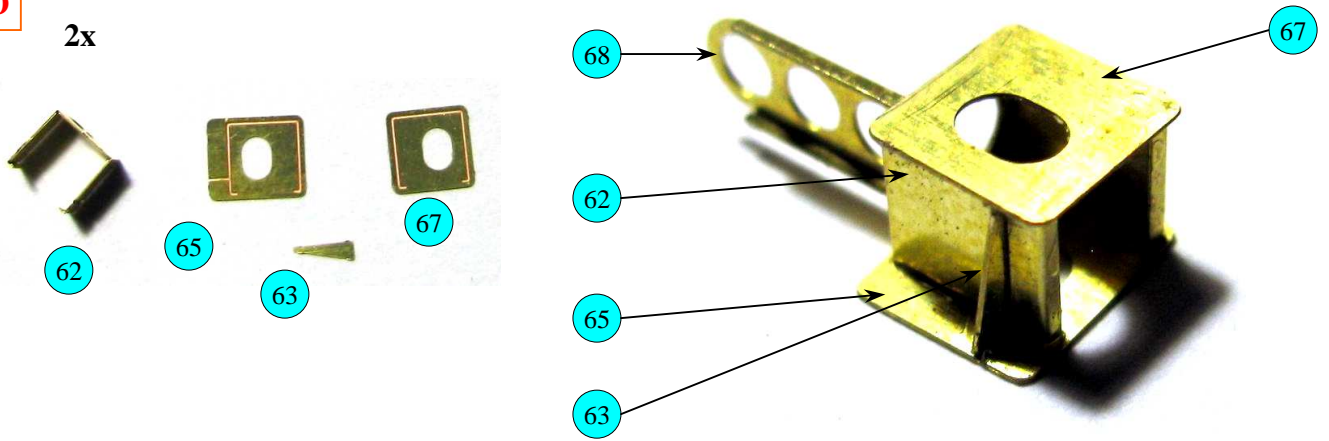

P

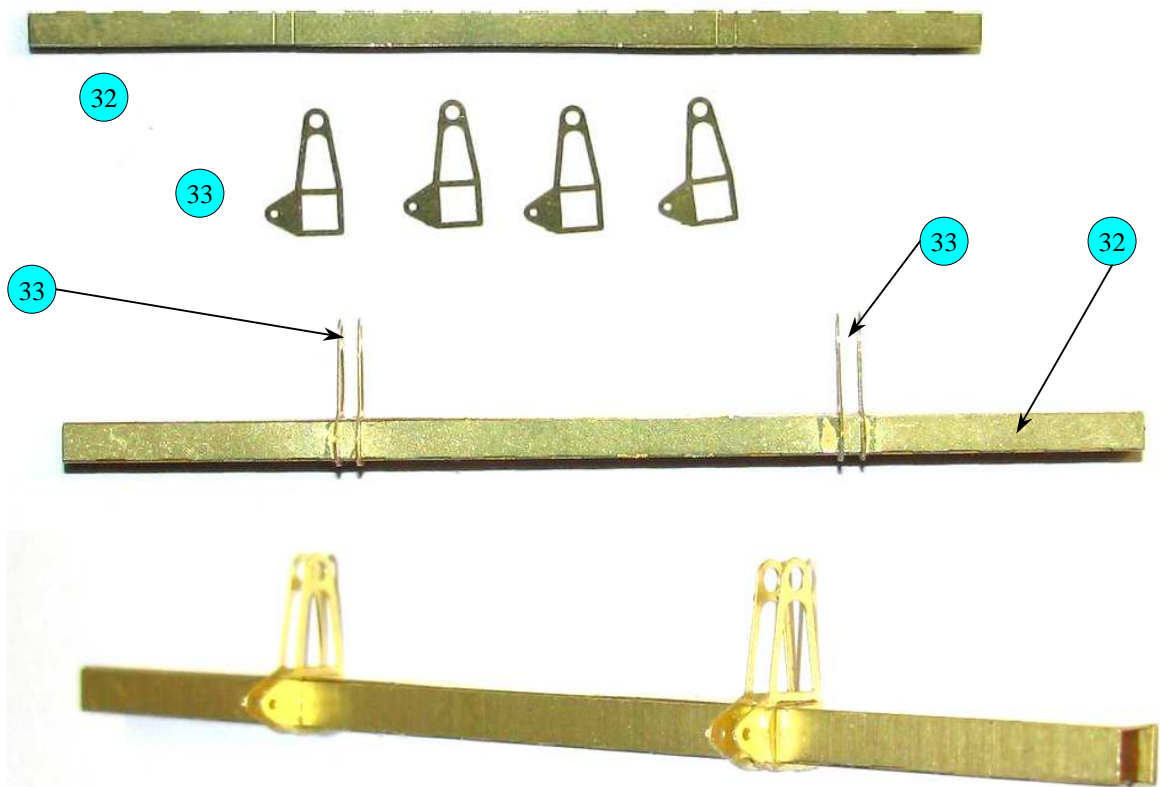

P

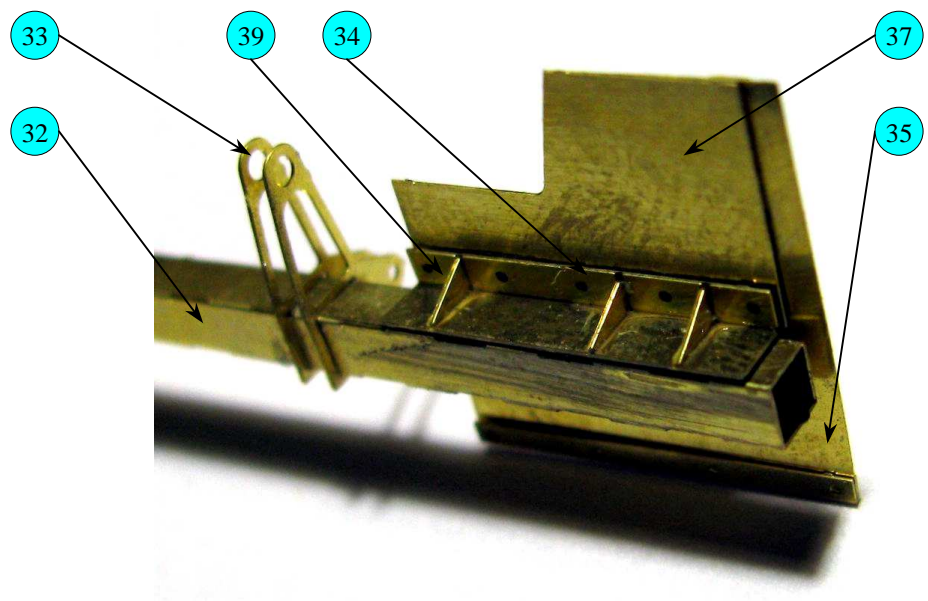
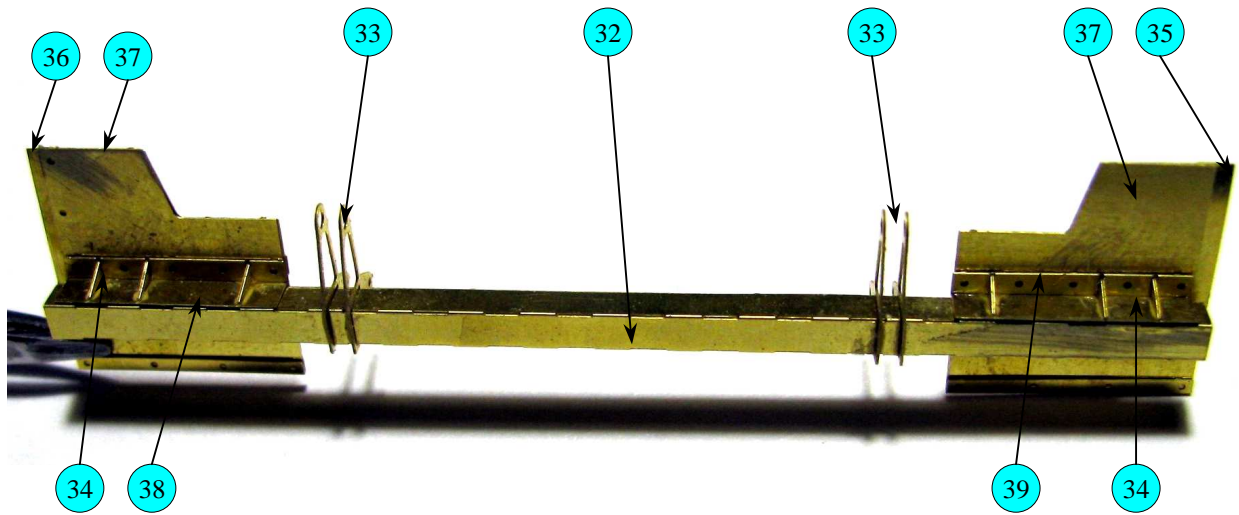
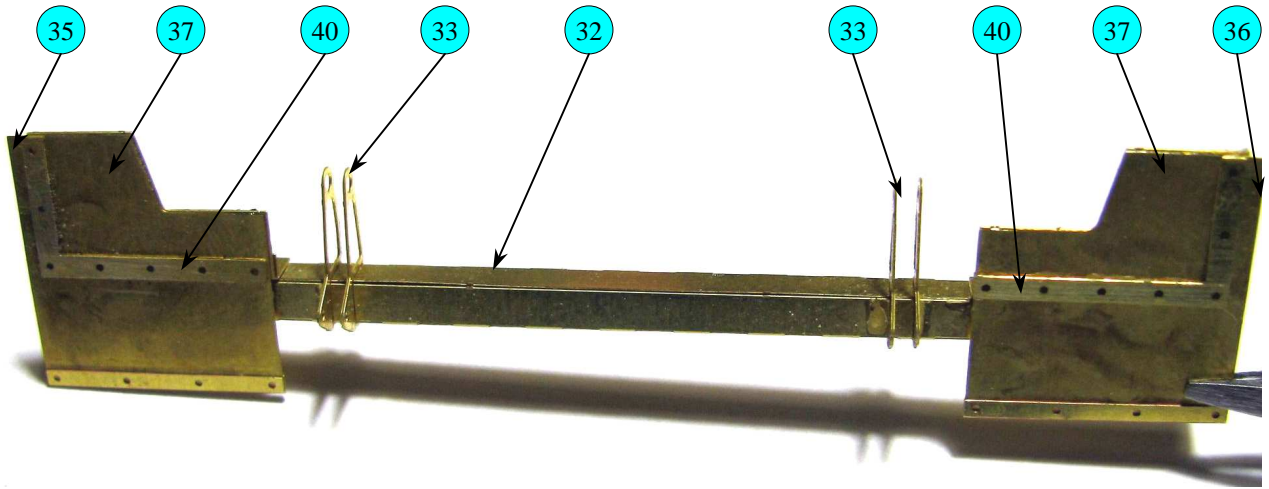

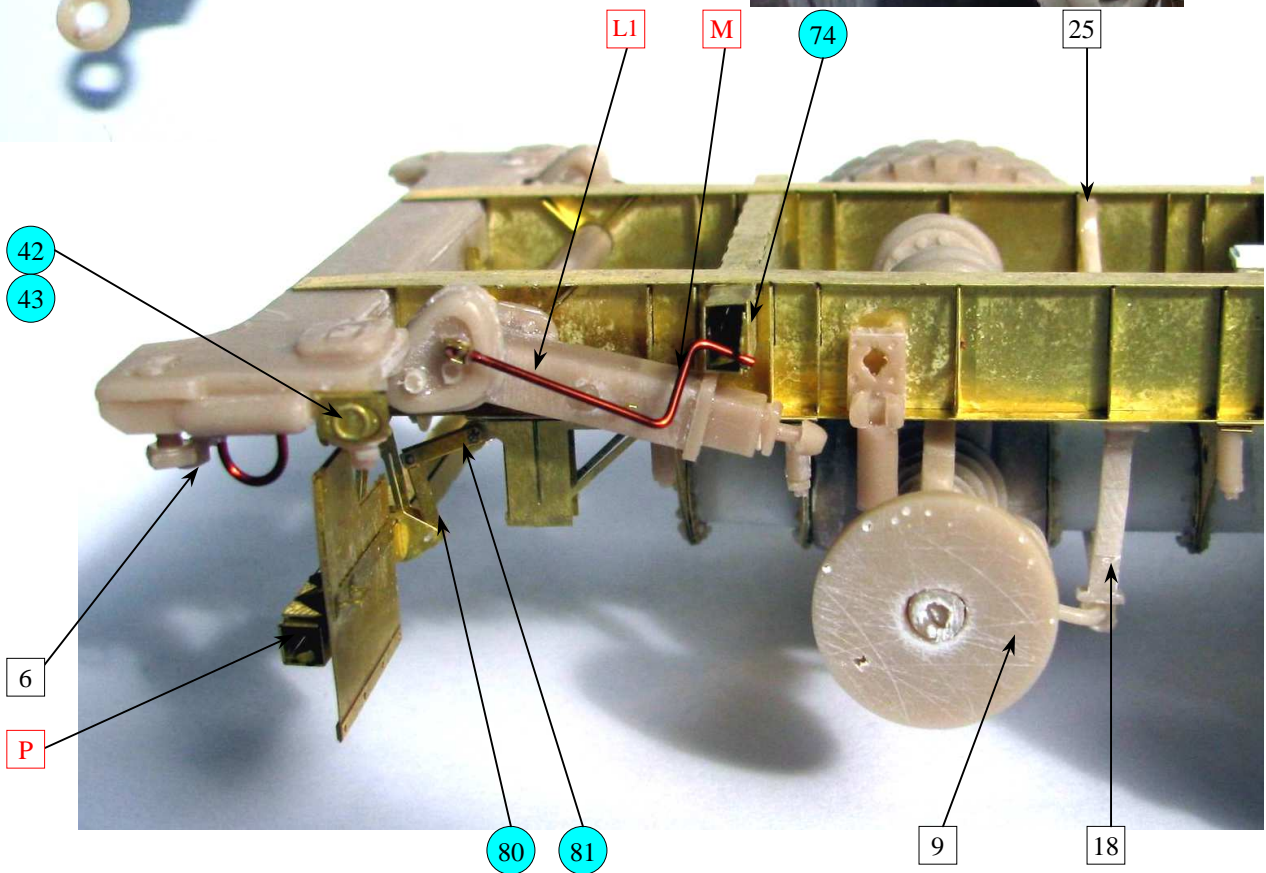
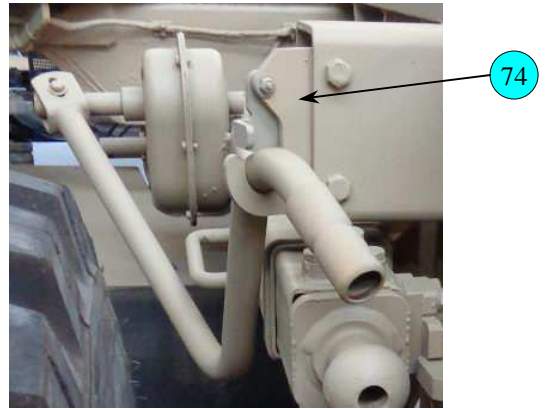
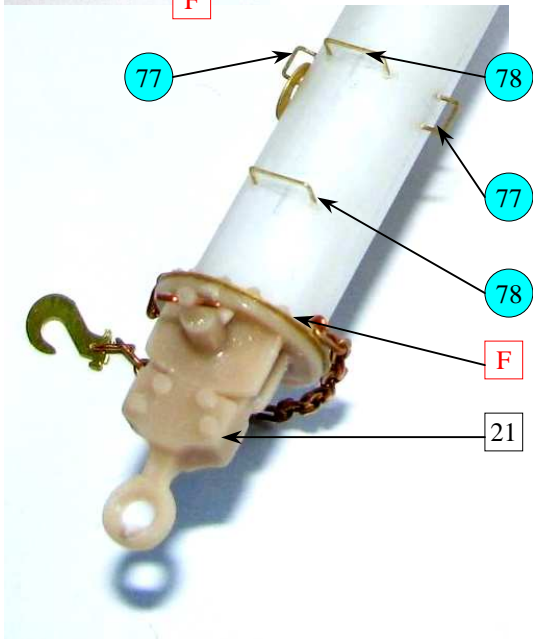
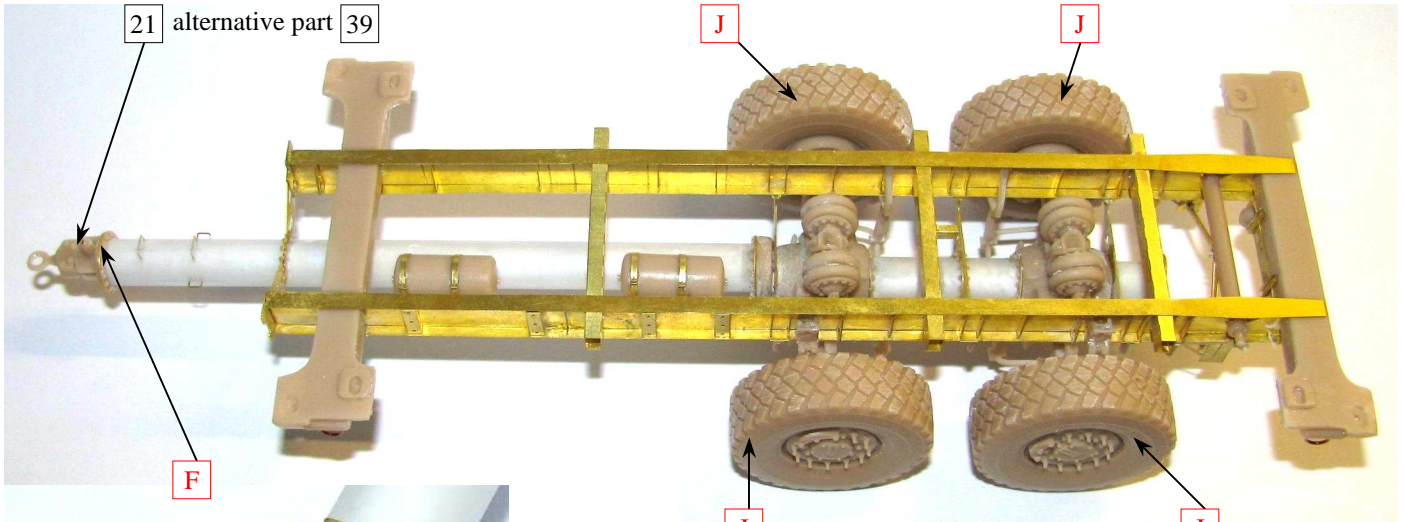

FAST II

1/35
17/20

návod

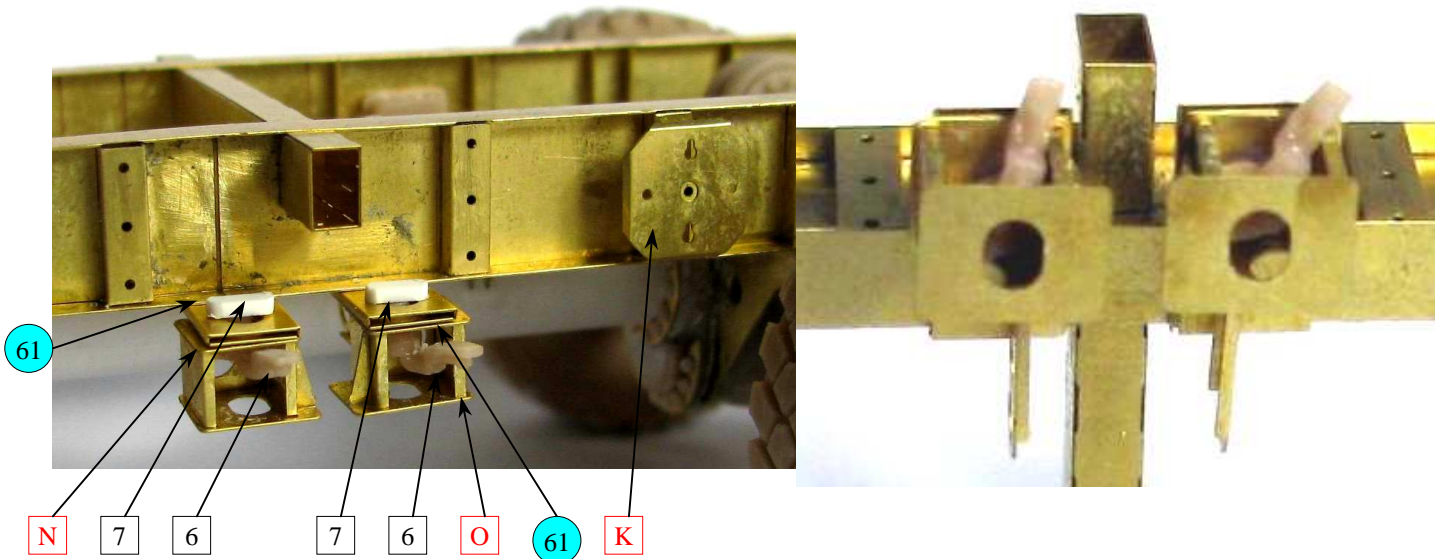
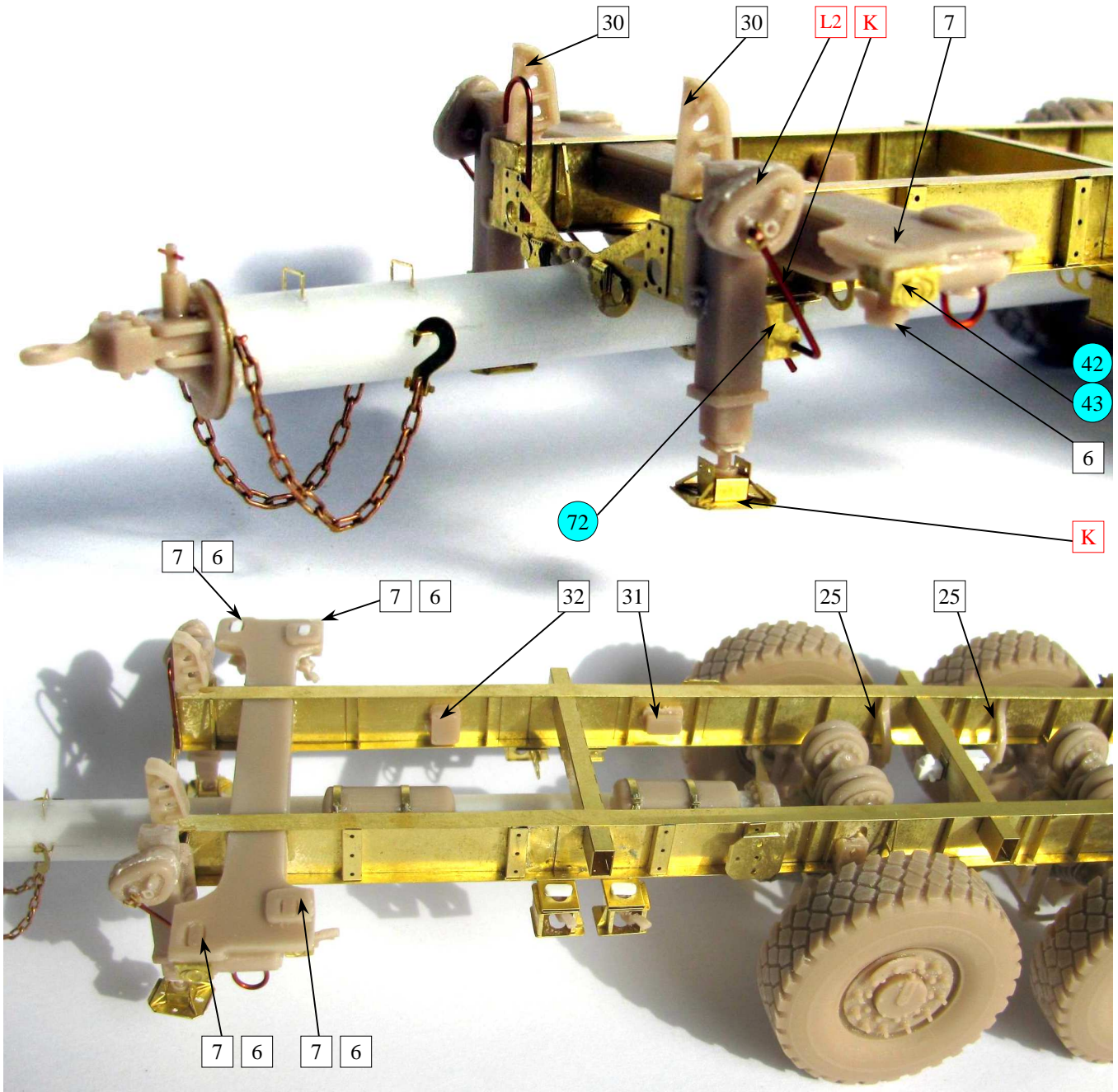

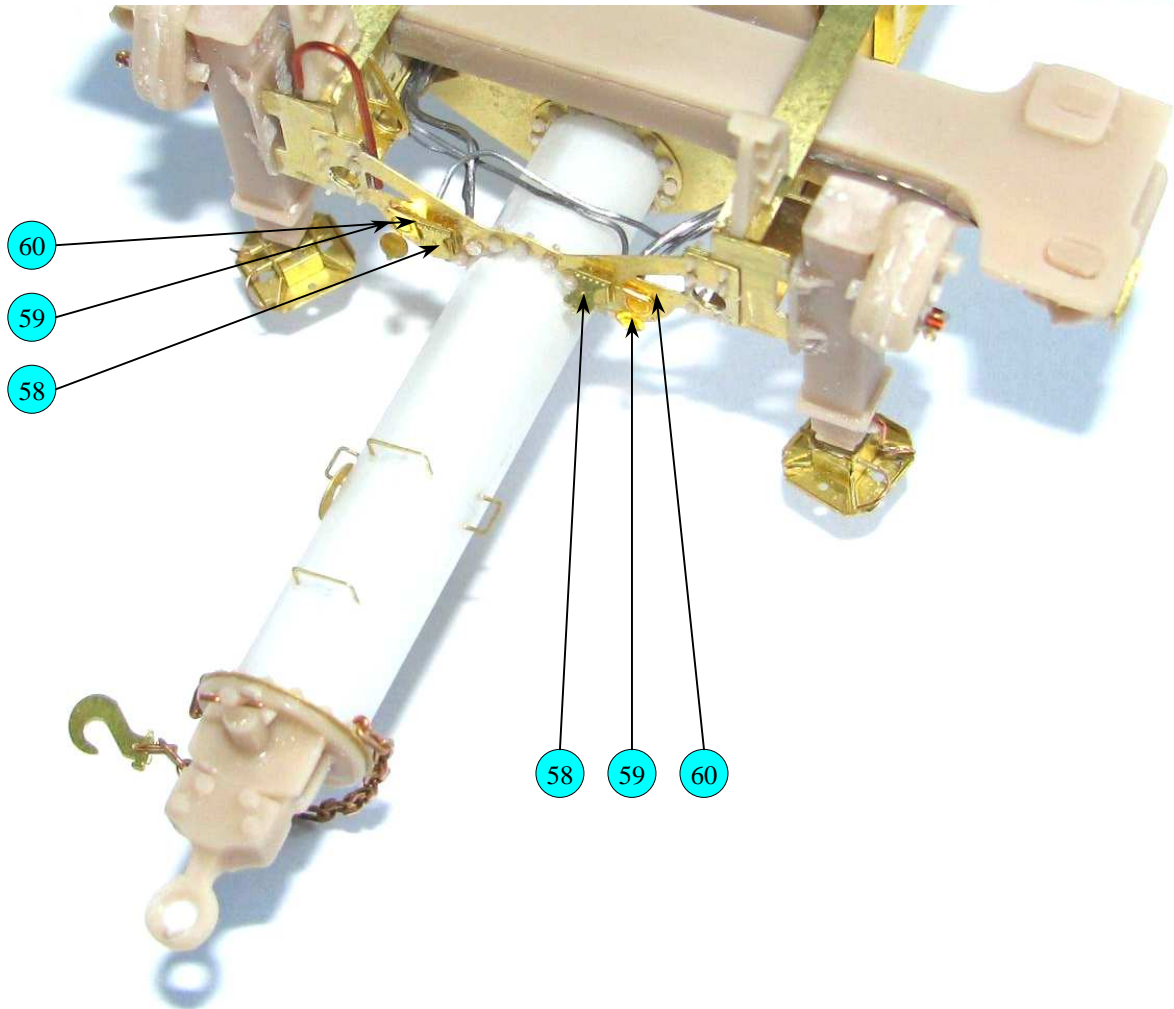
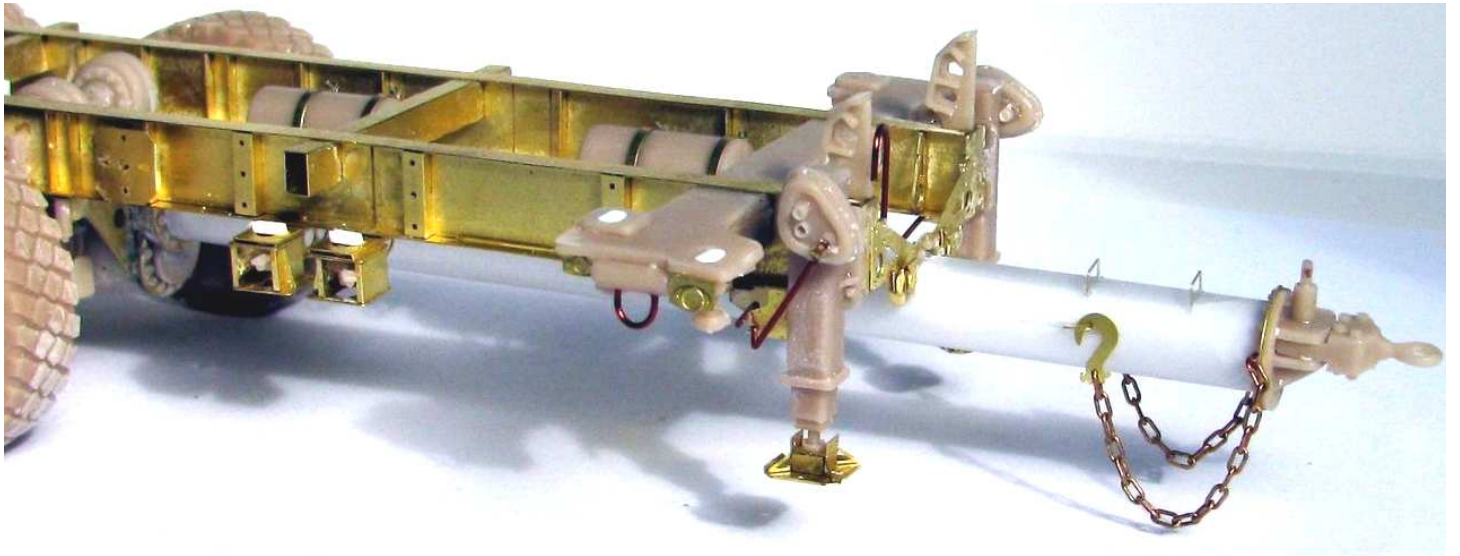
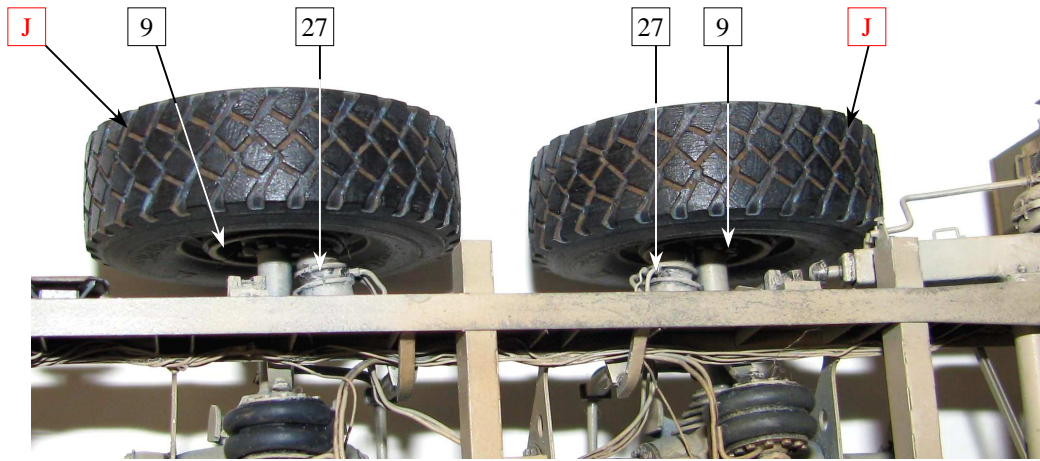

Configuration for transporting 20-foot containers

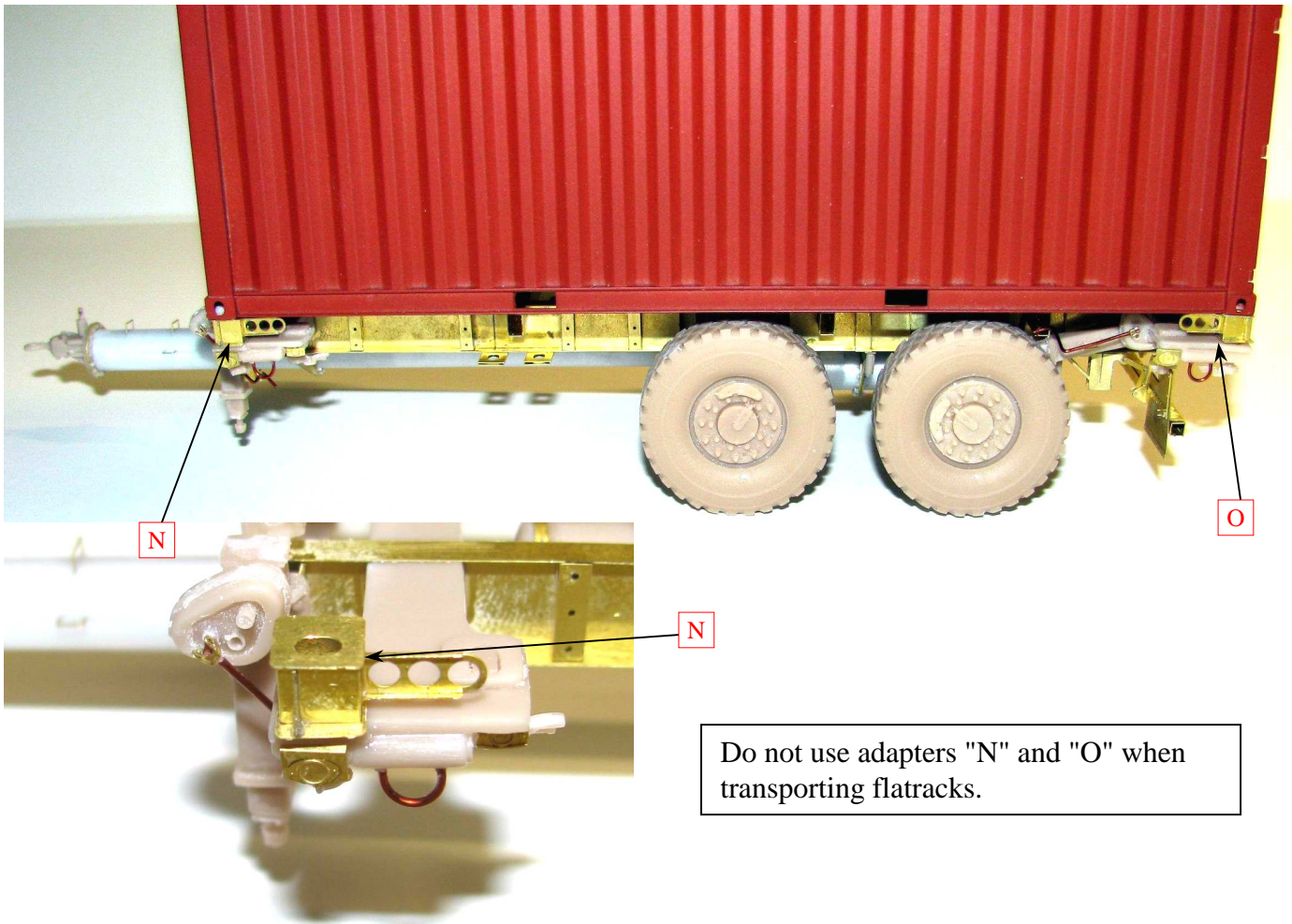

Do not use adapters "N" and "O" when transporting flatracks.

