

T138-VNM

1/35

35069

2/20

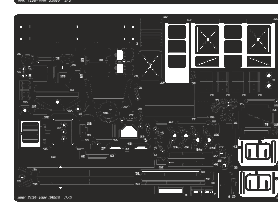
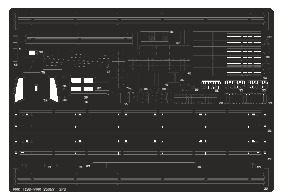
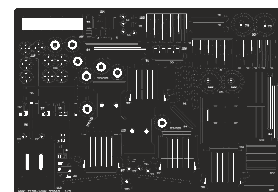
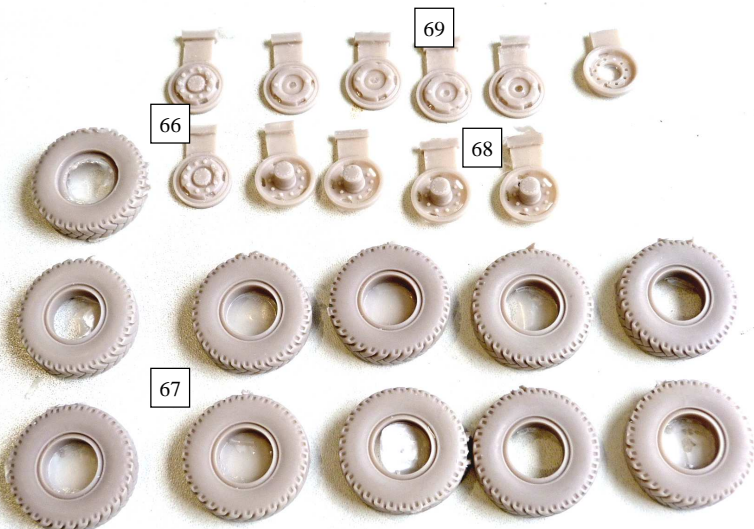
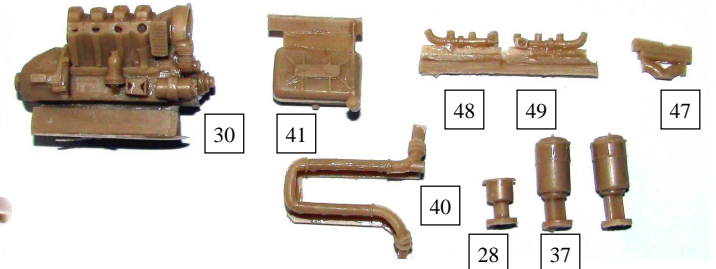
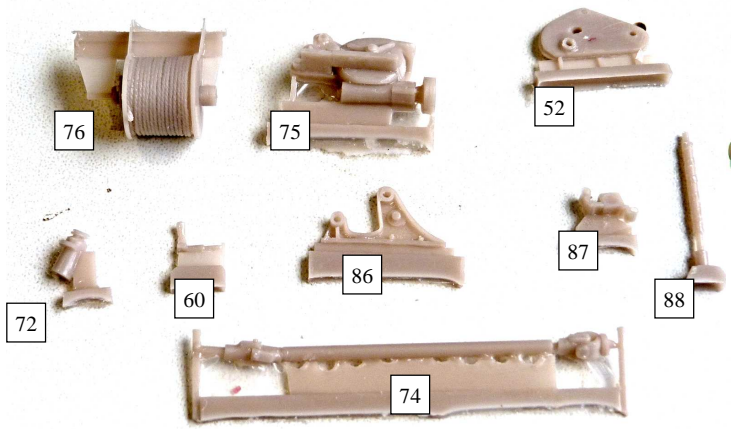
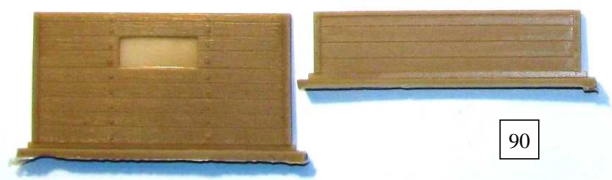
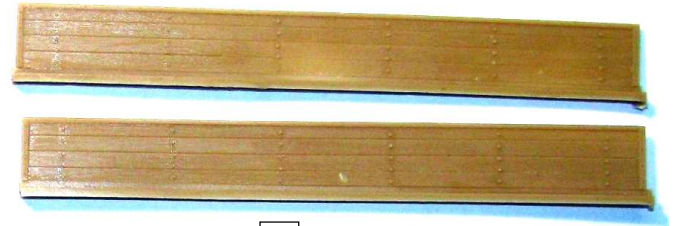
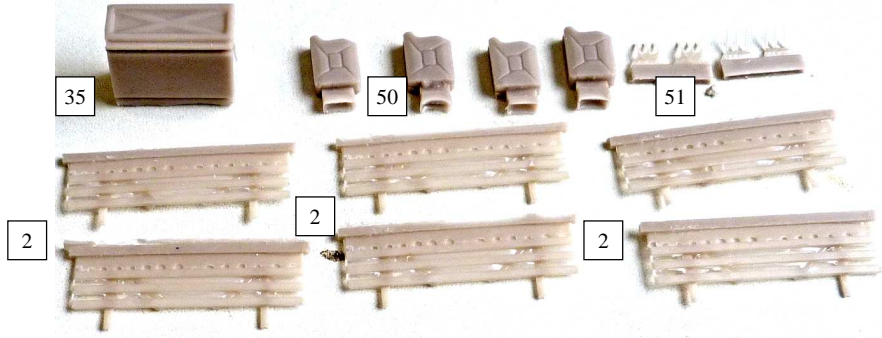

XX - RESIN PARTS

X - PHOTO-ETCHED PARTS 35056

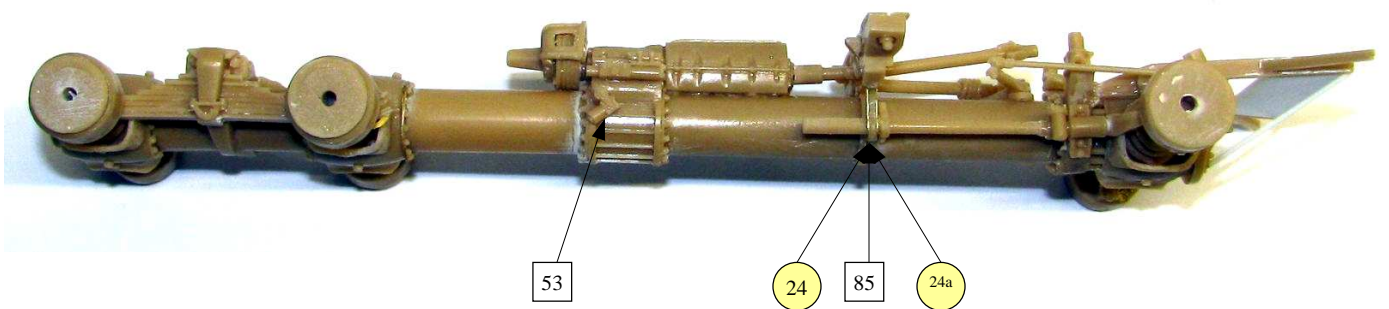
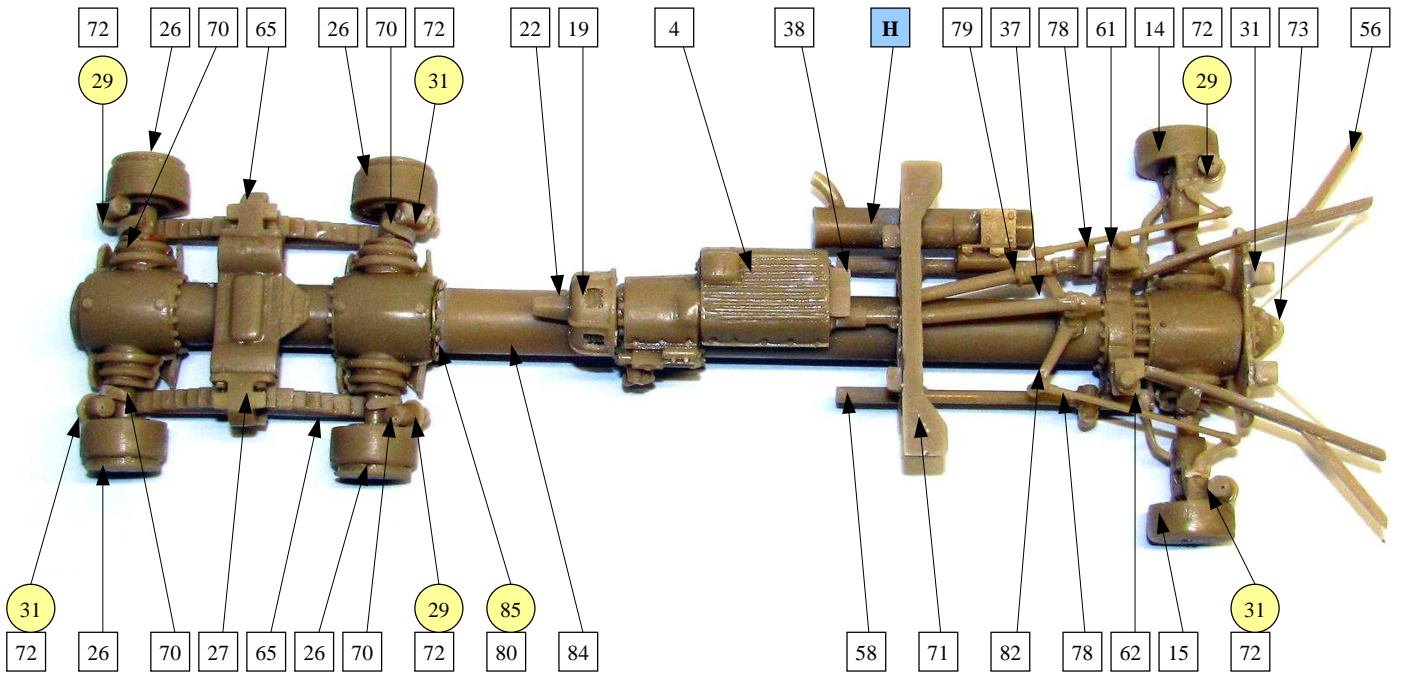
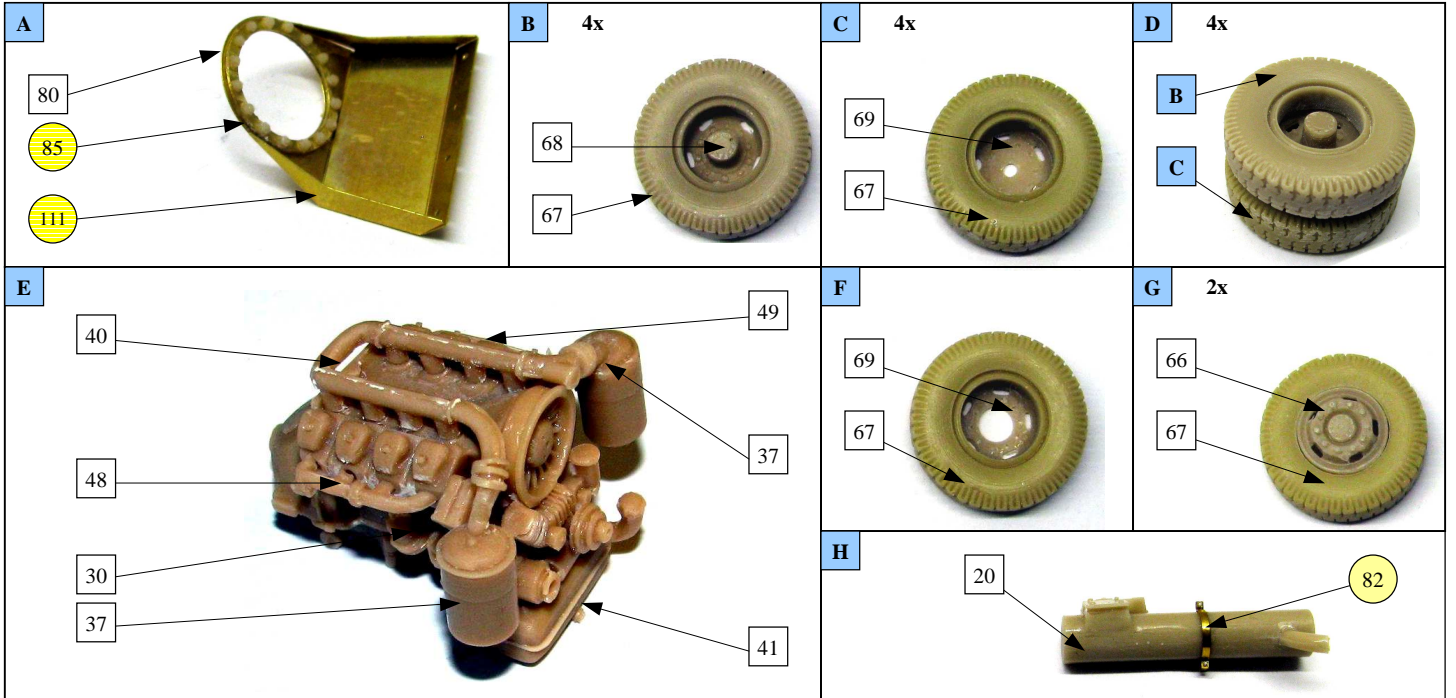
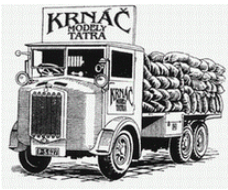

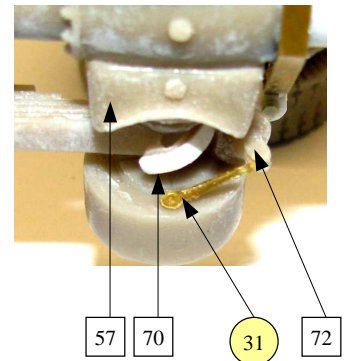
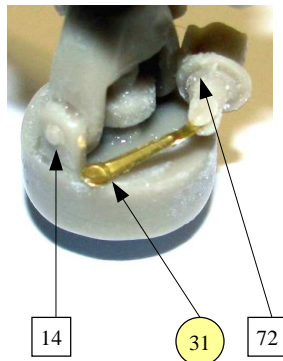
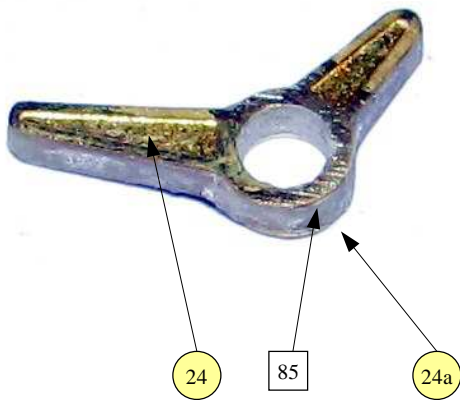
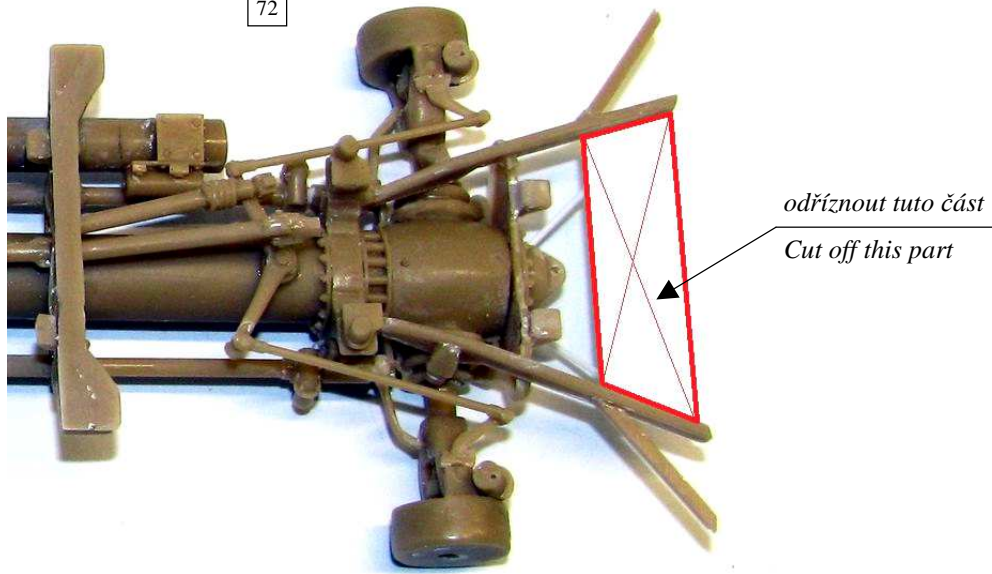
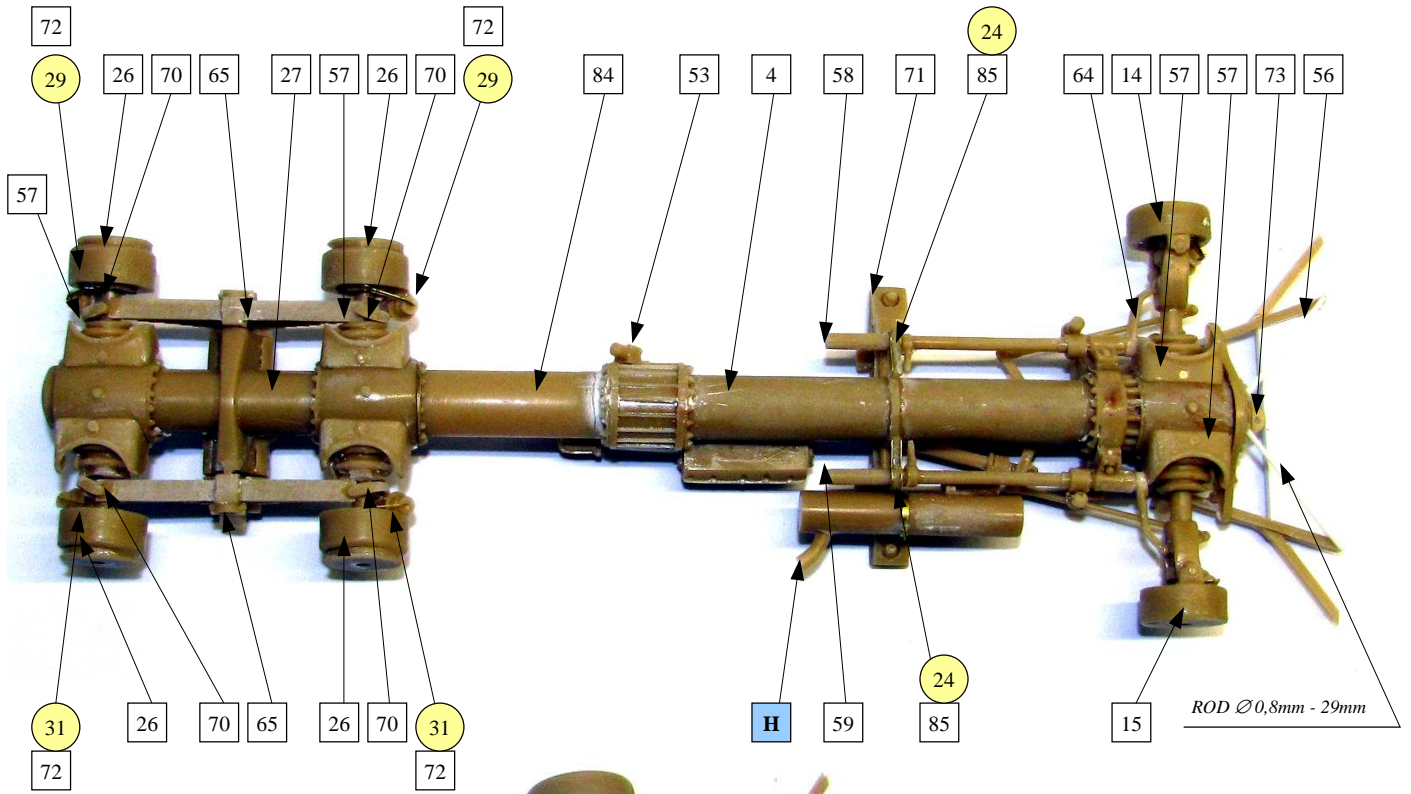
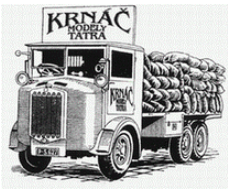

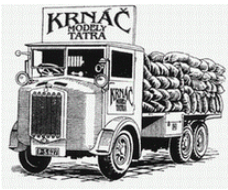

T138-VNM

1/35

35069

5/20

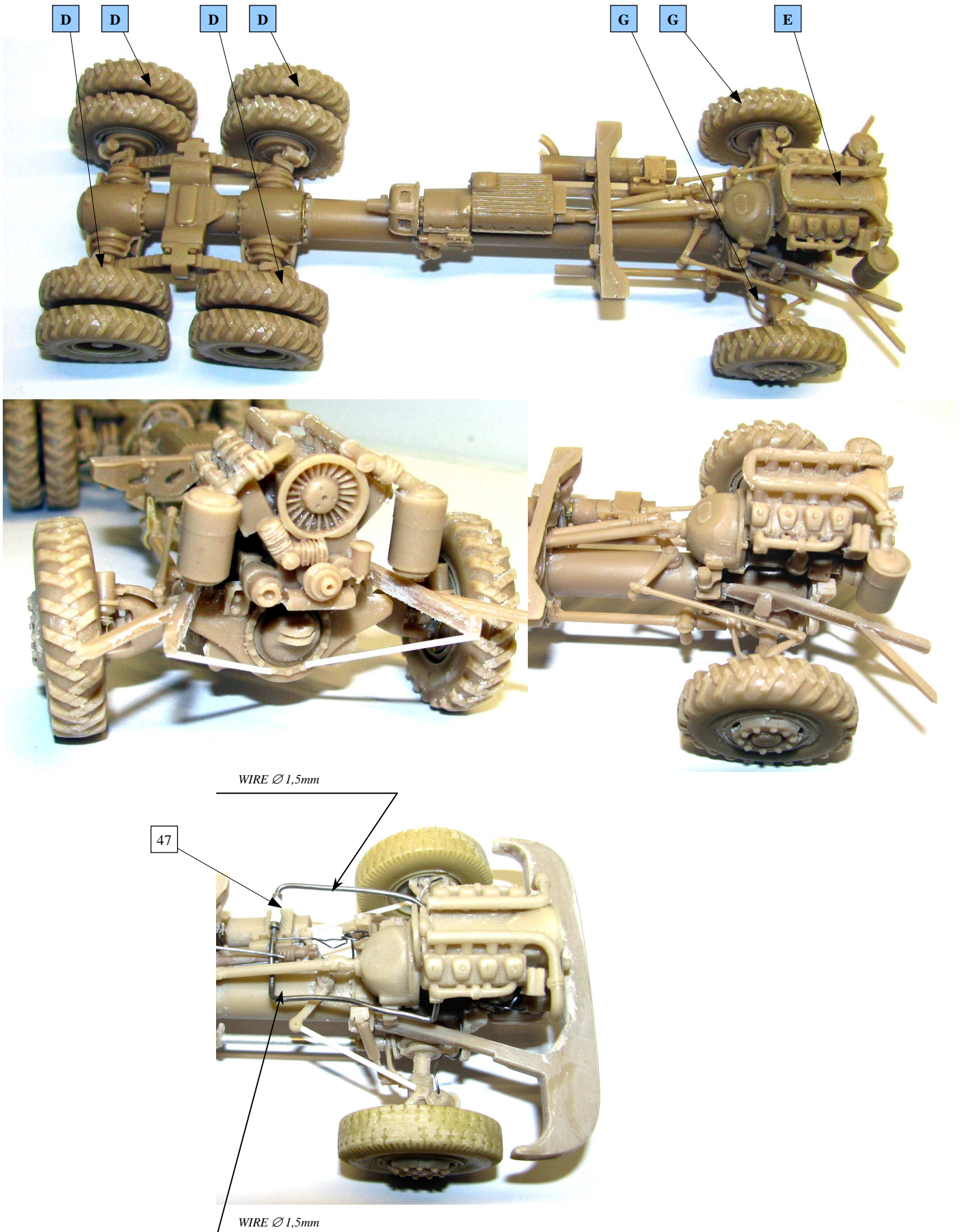

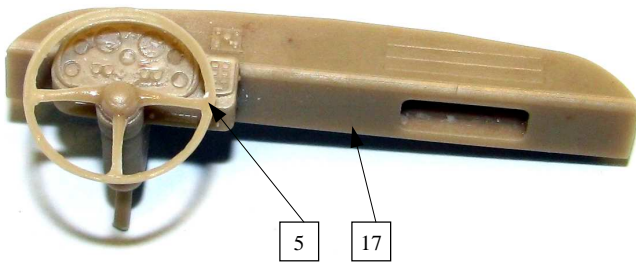
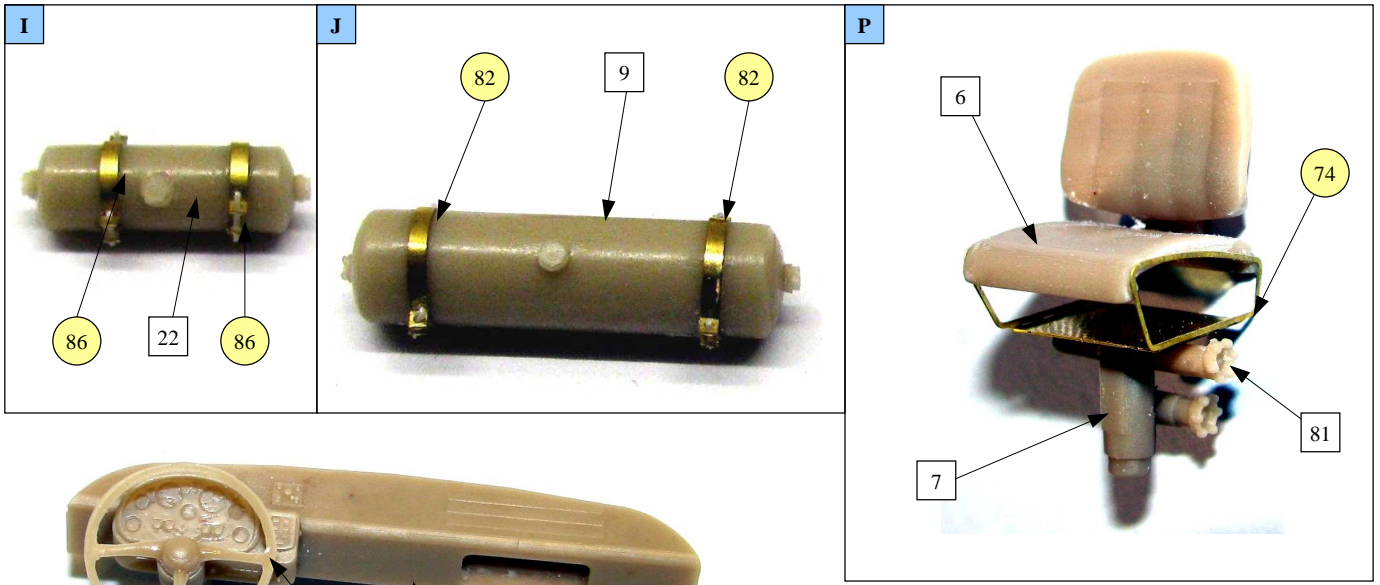
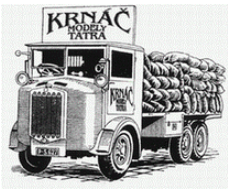

PLASTIC ROD $\varnothing 0,5 - 1mm$ WIRE $\varnothing 0,4 - 6mm$

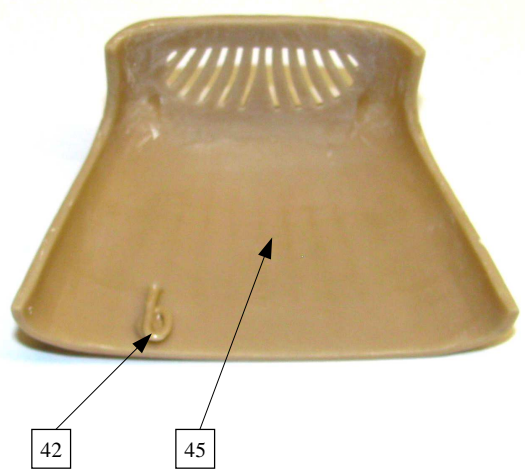
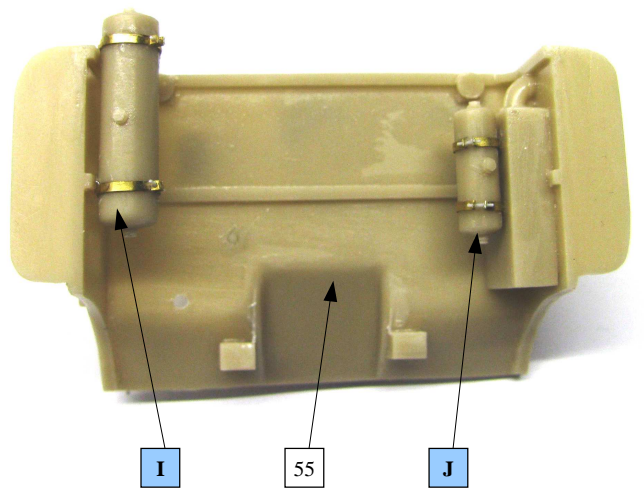
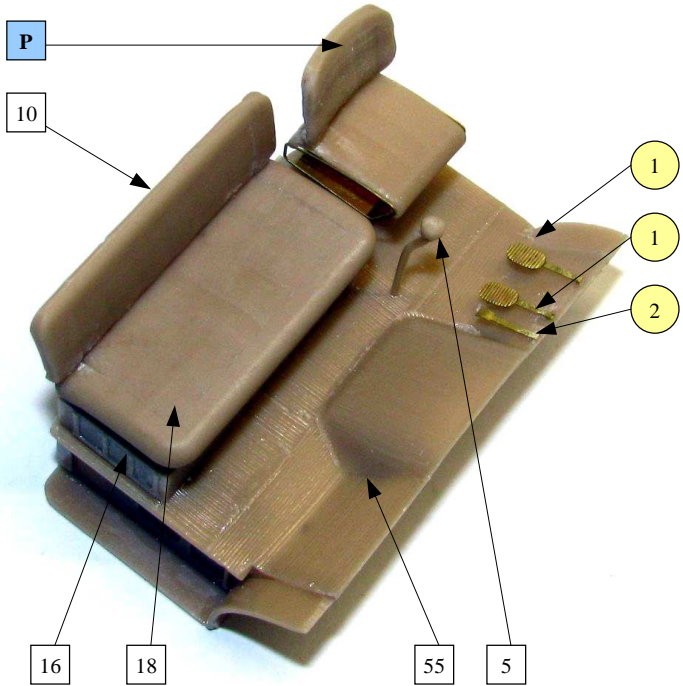
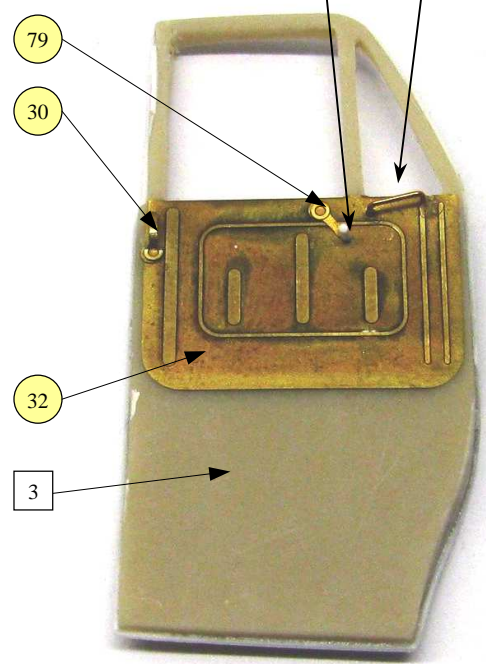

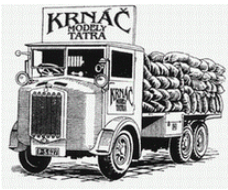

T138-VNM

1/35

35069

7/20

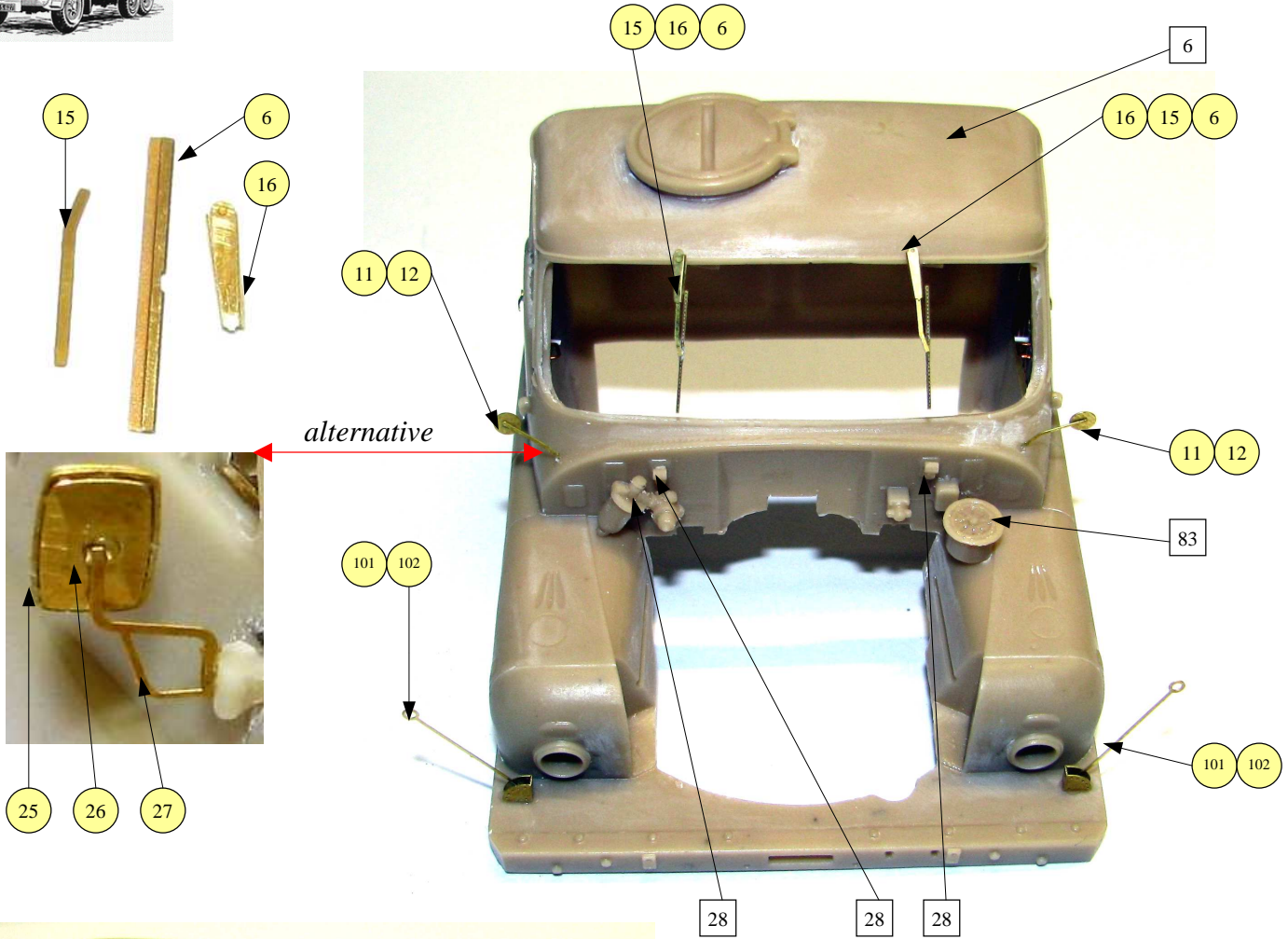

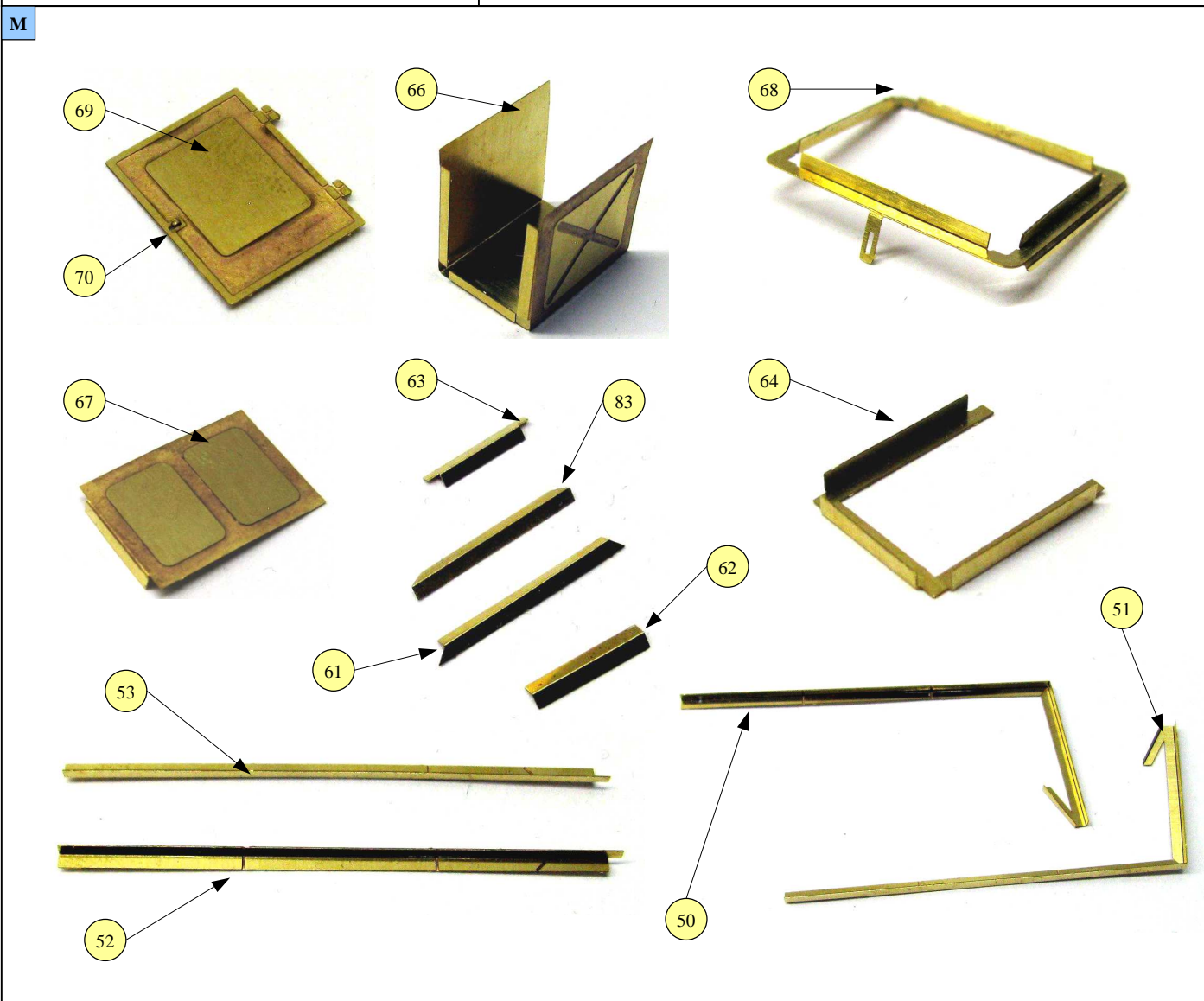
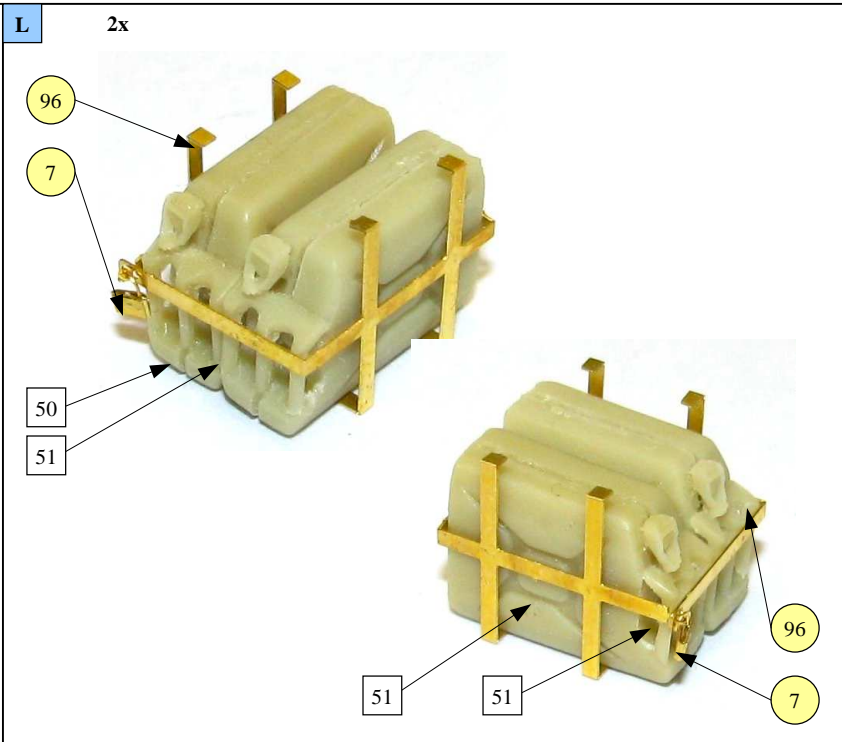
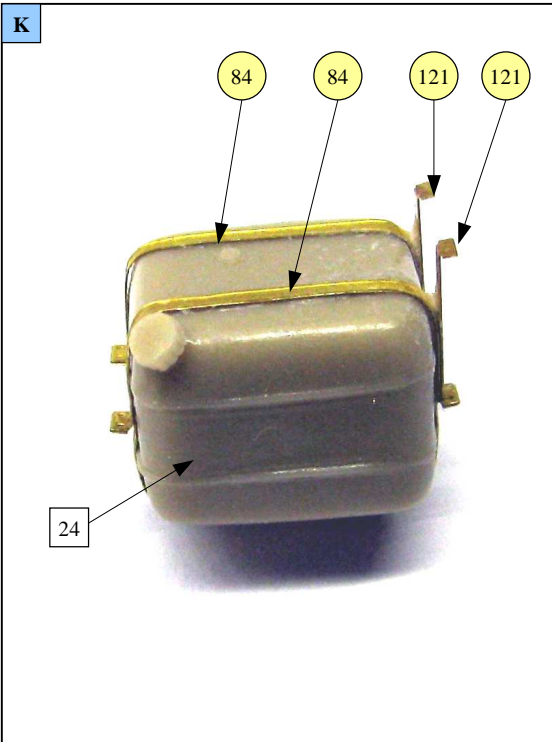



M

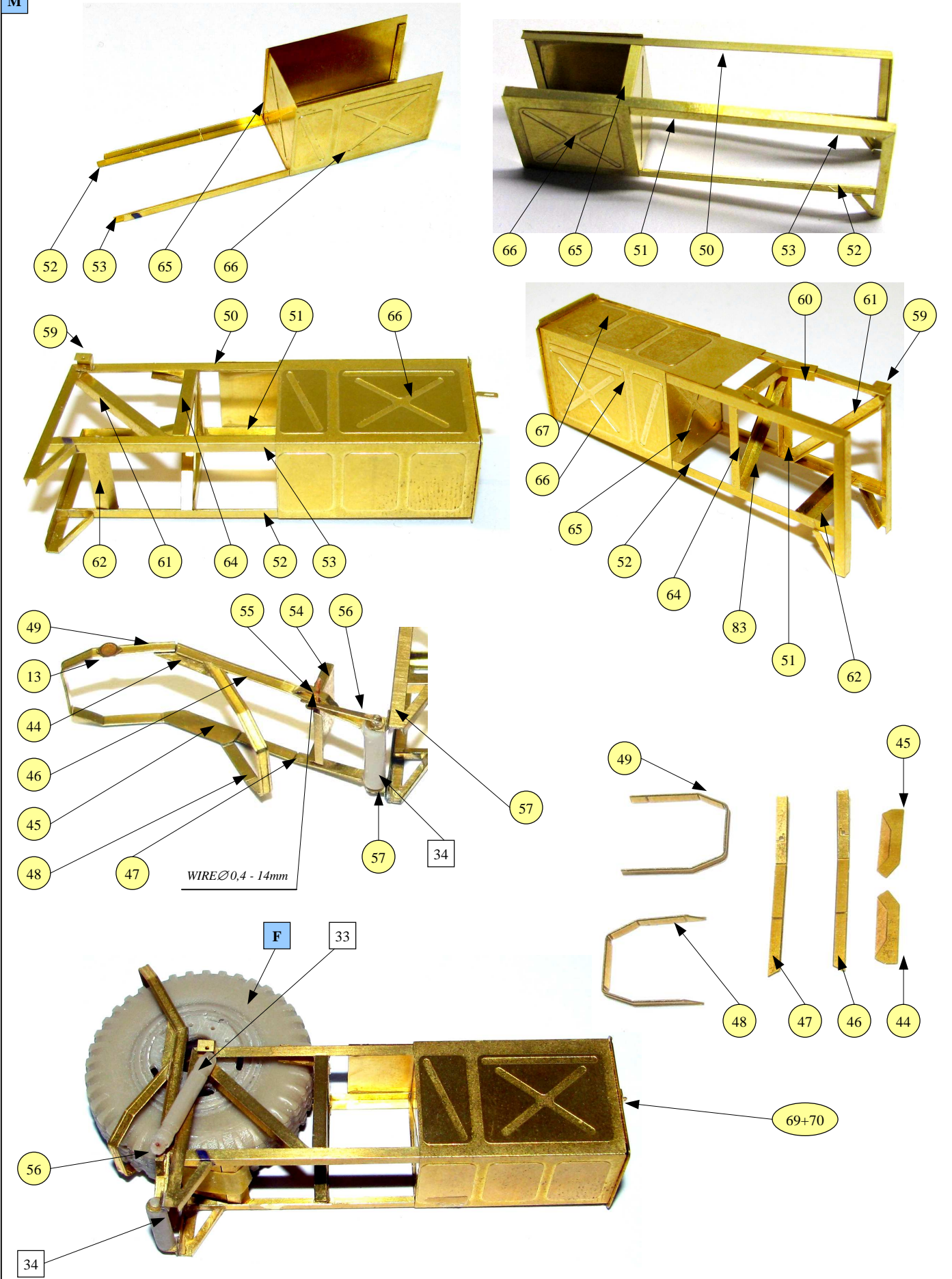

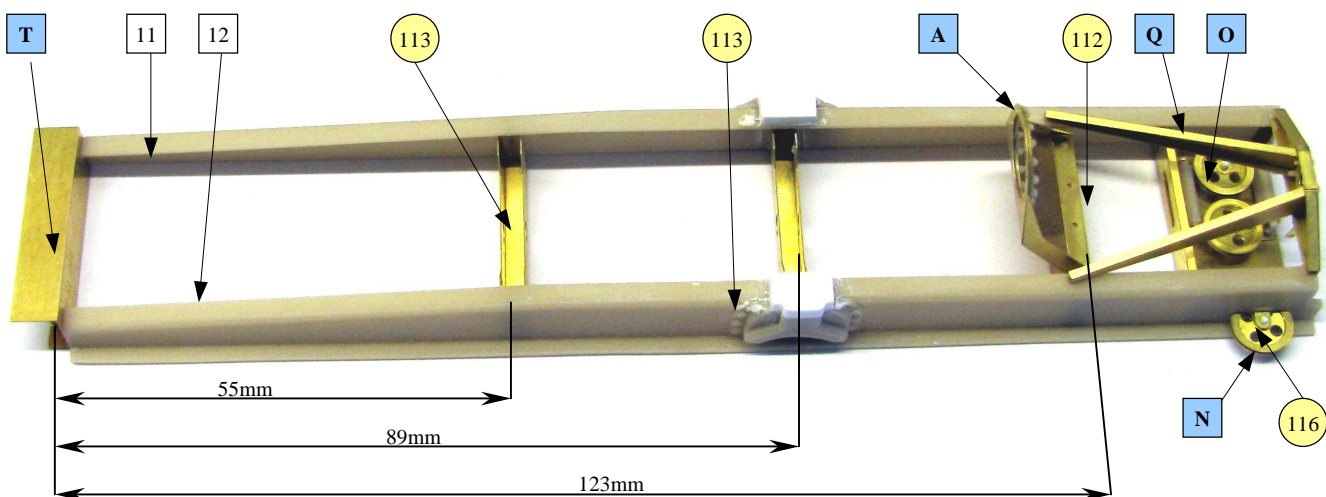
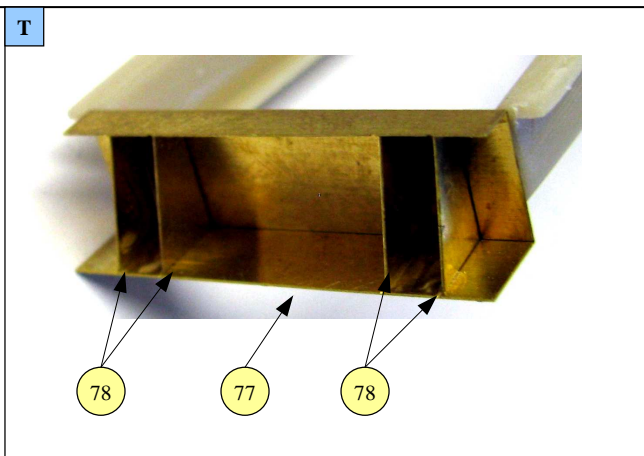
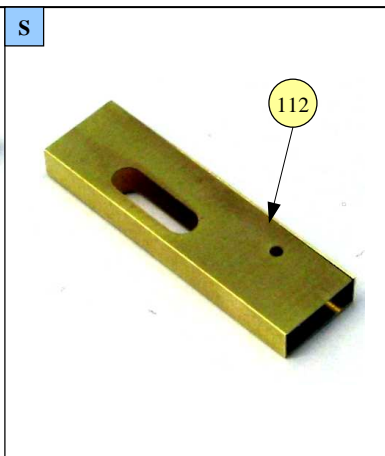
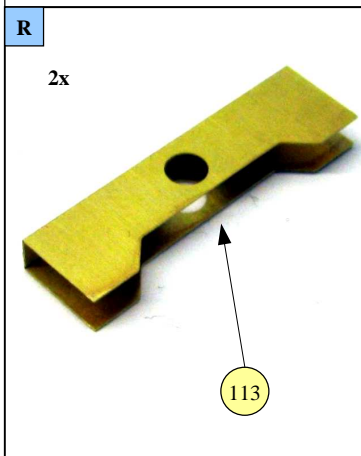
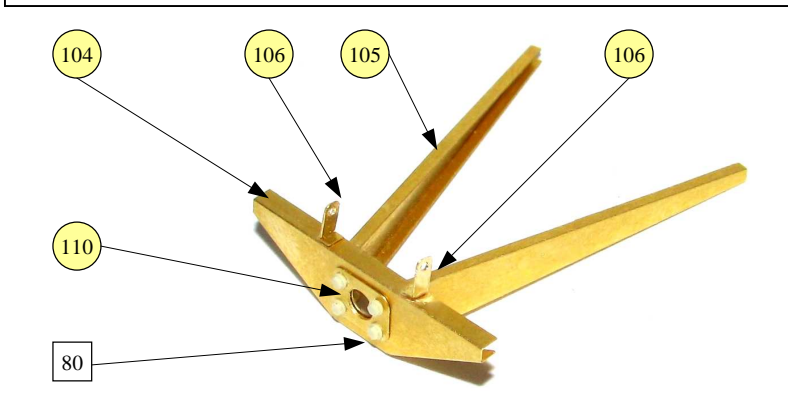
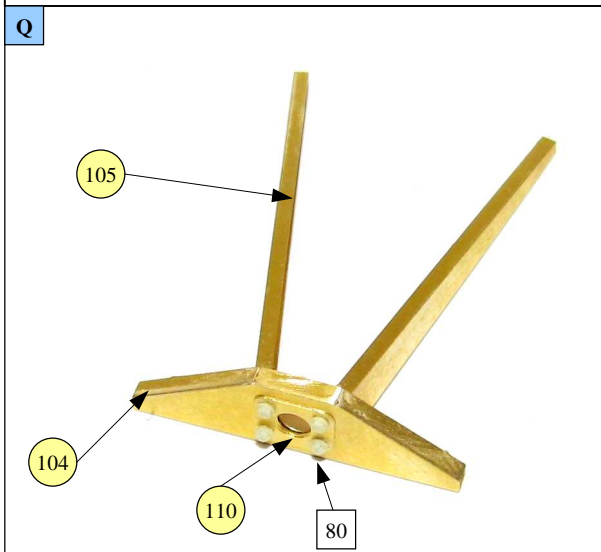
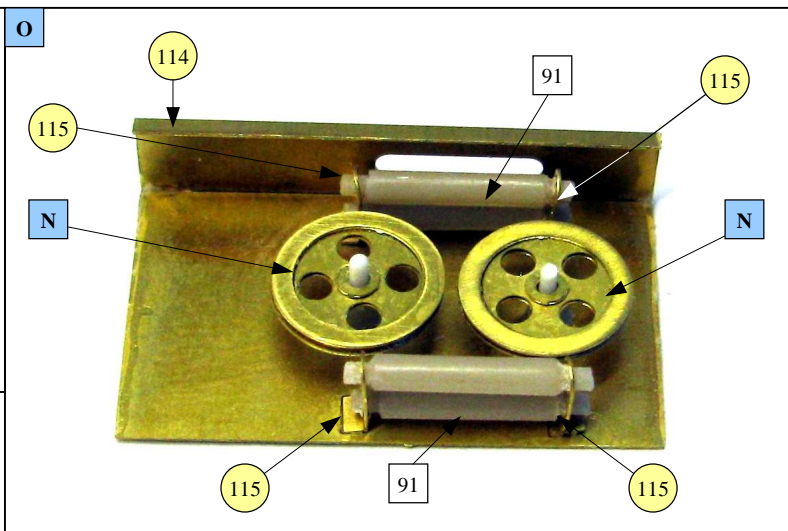
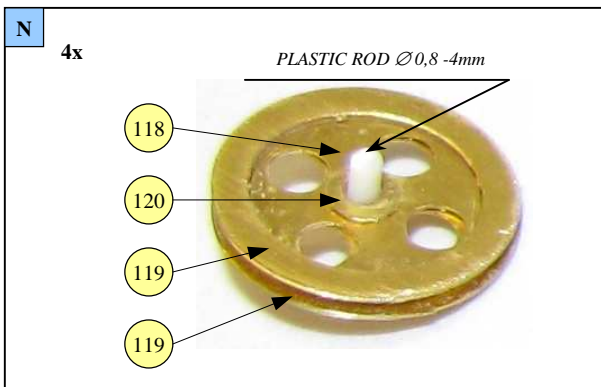

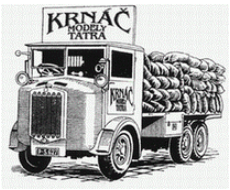

T138-VNM

1/35

35069

11/20

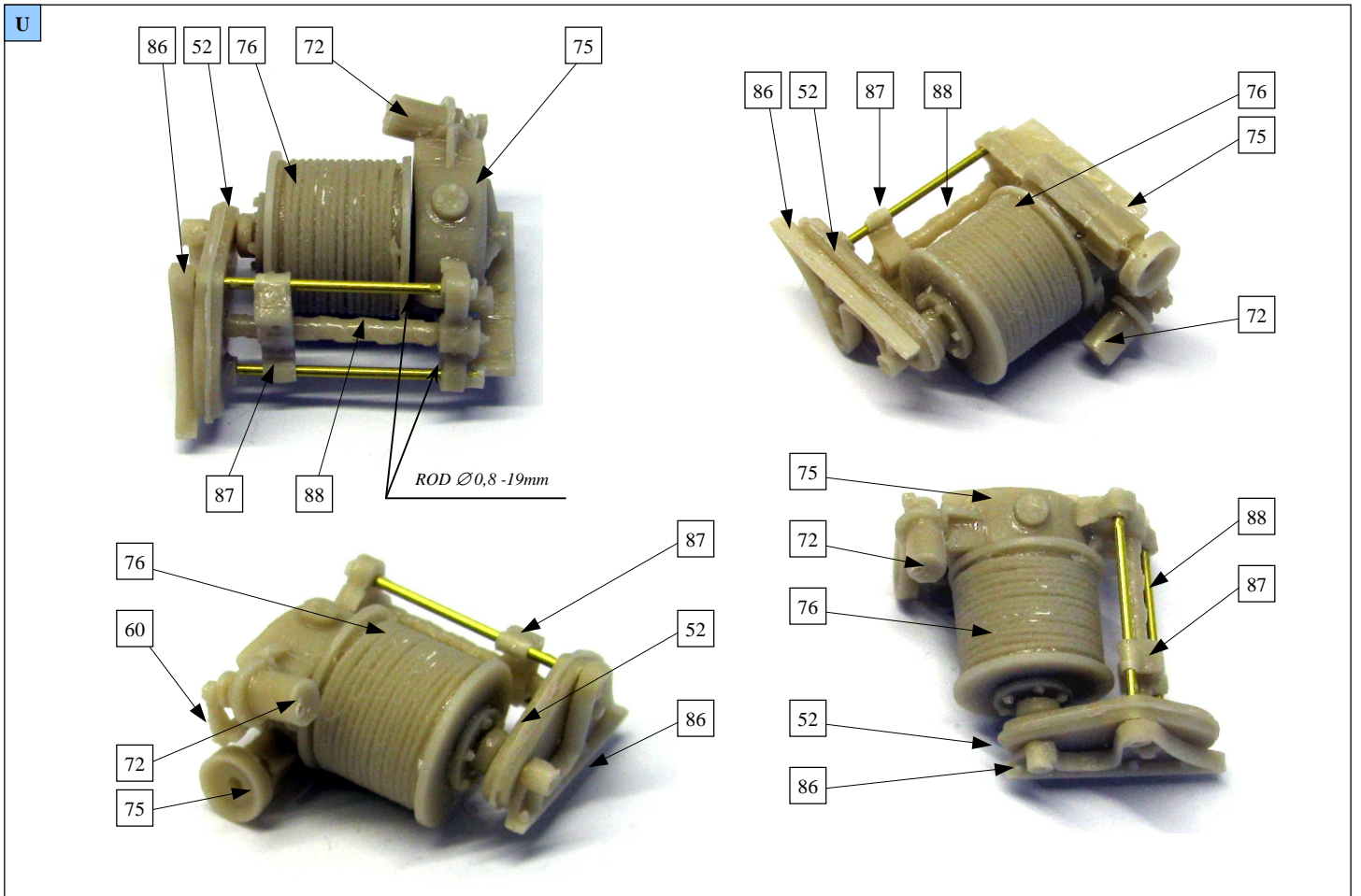
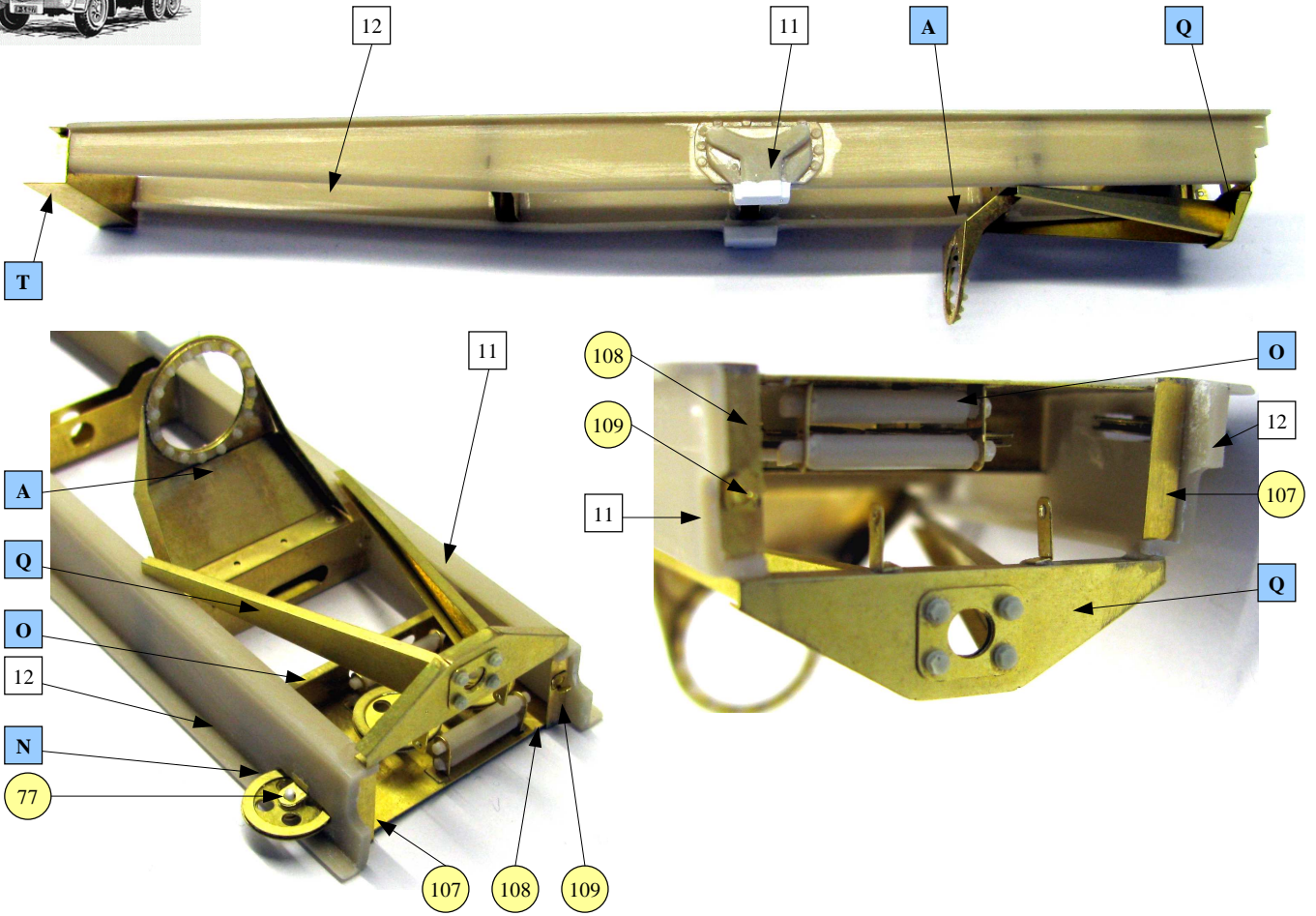

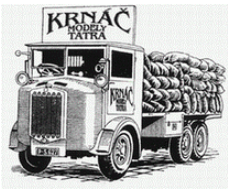

V

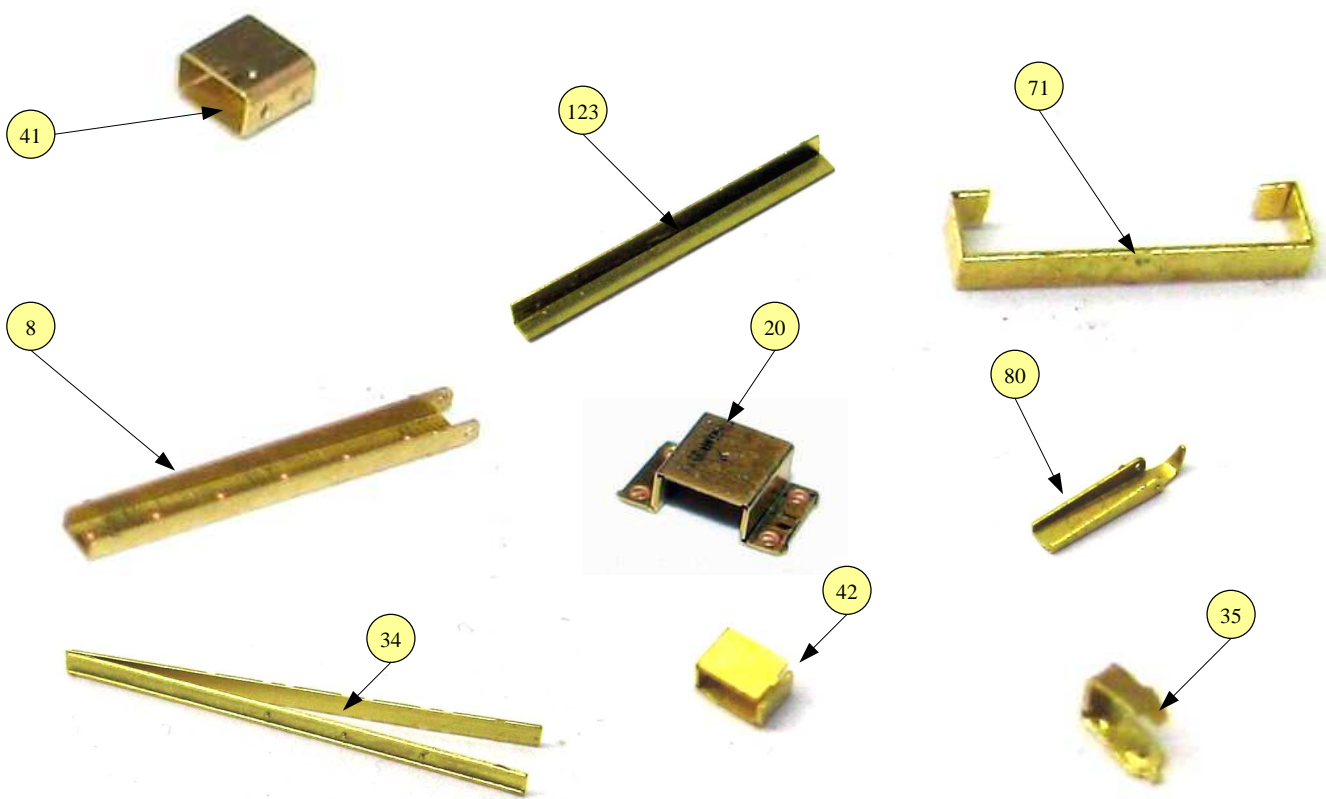
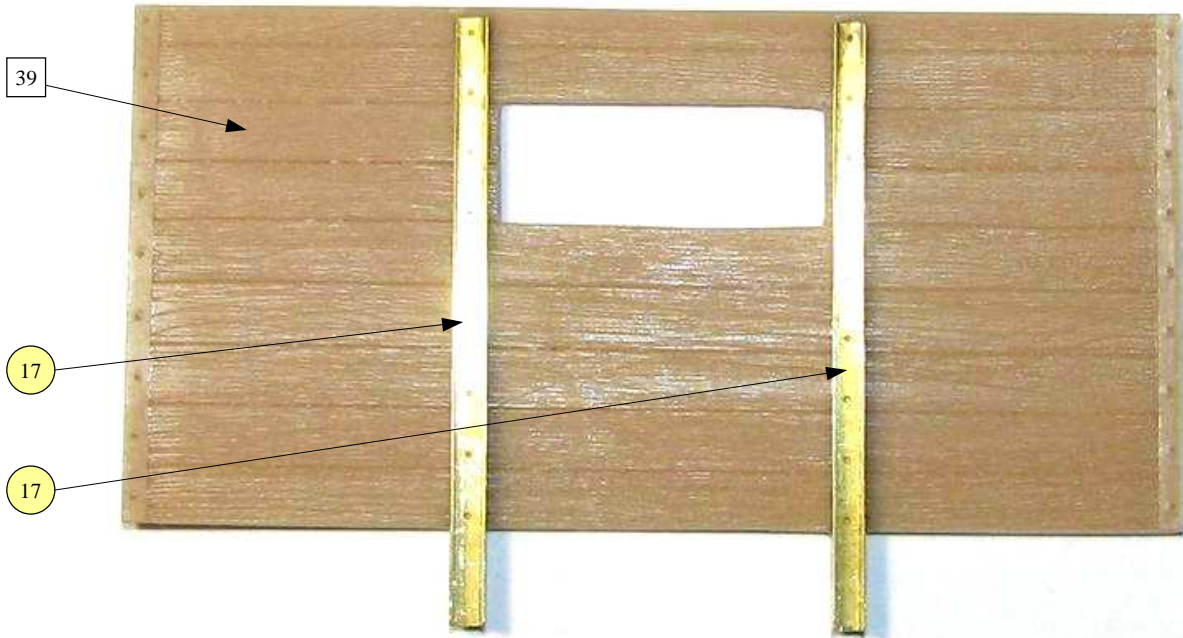



W

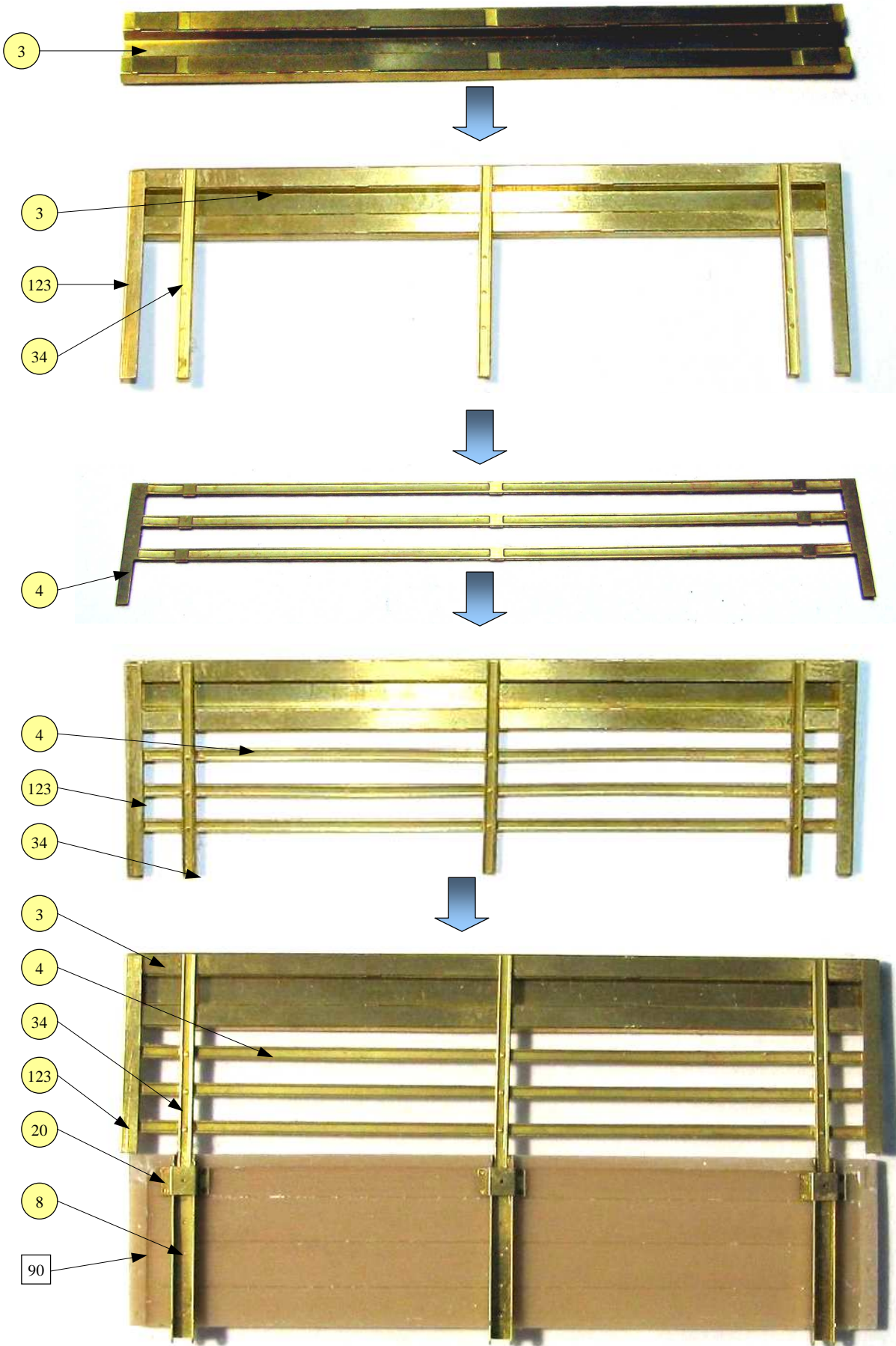

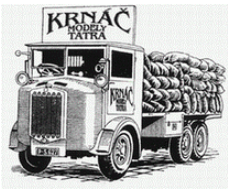

X

2x

21



22

34

123

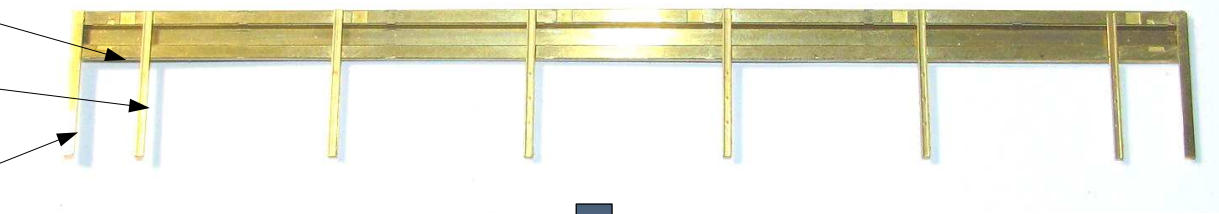

22



21

34

123



22



21

123

22

20

8

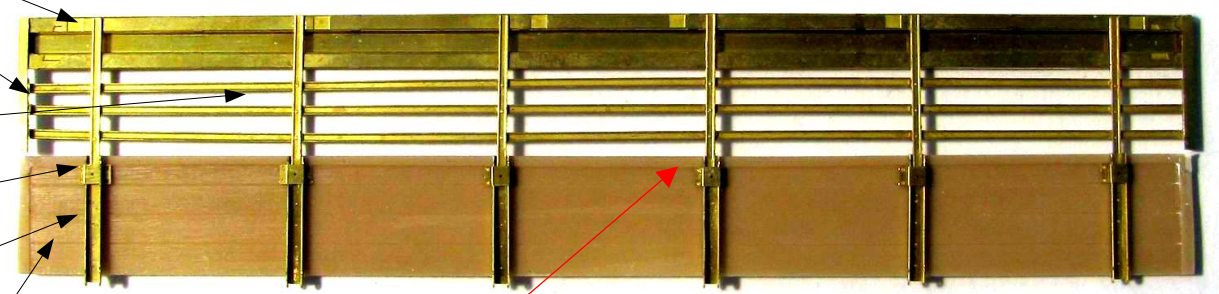

89

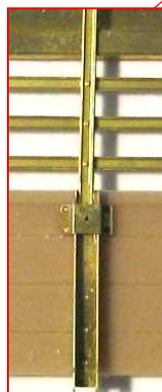

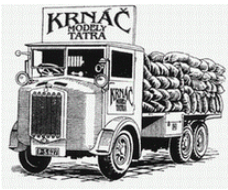

T138-VNM

1/35

35069

15/20

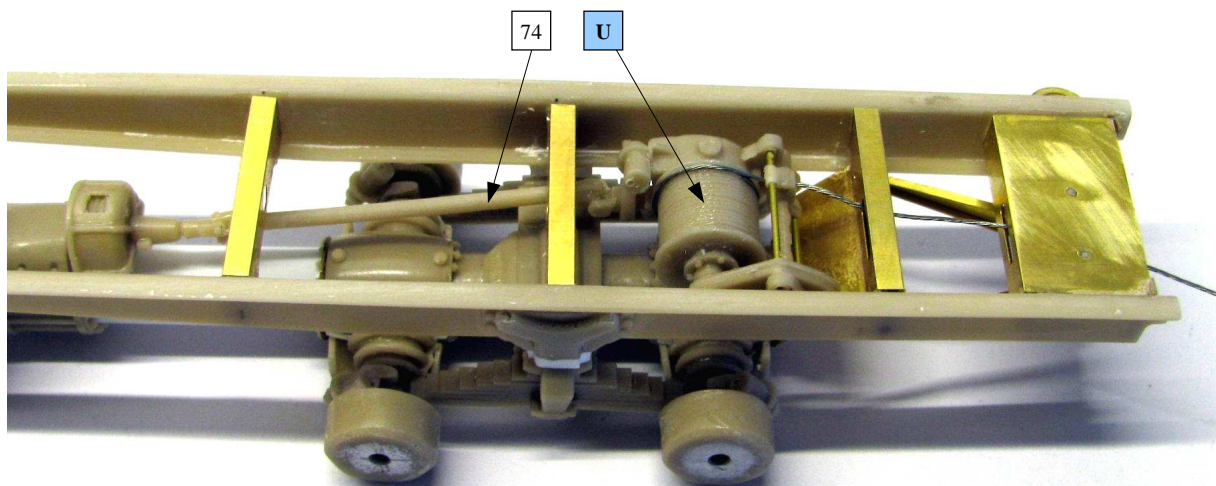

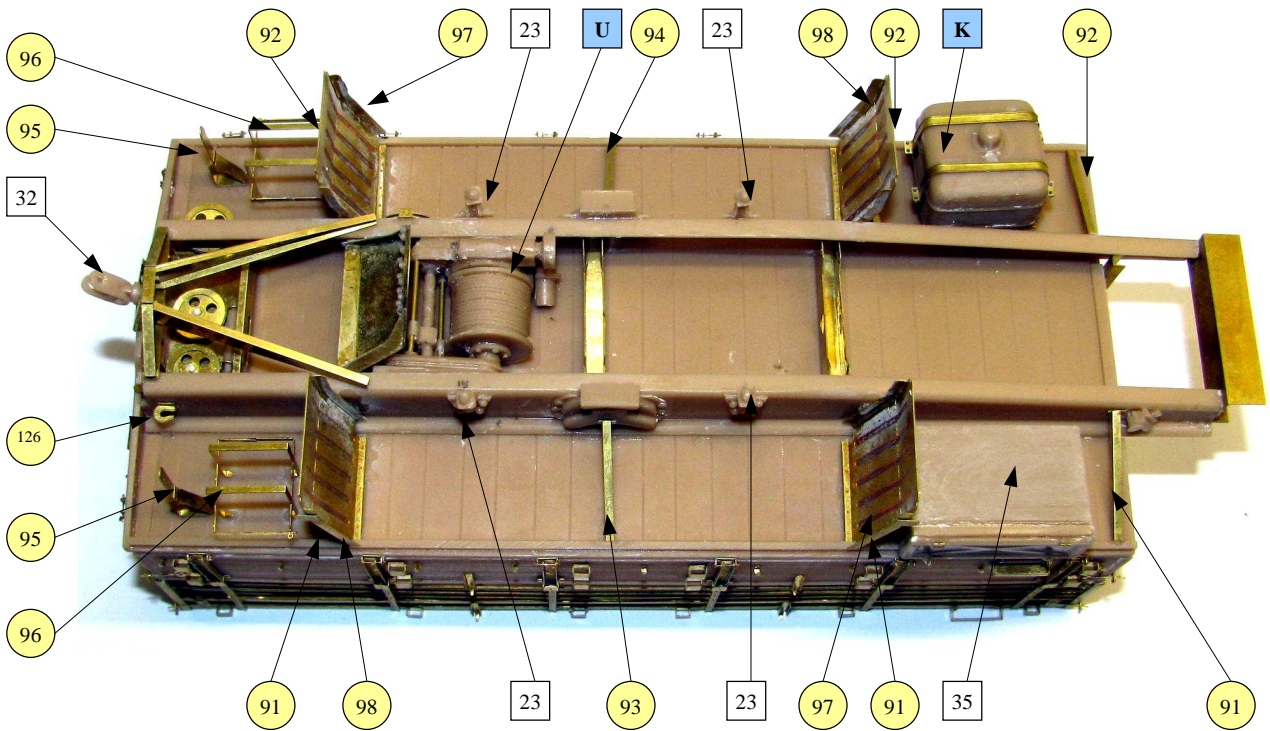
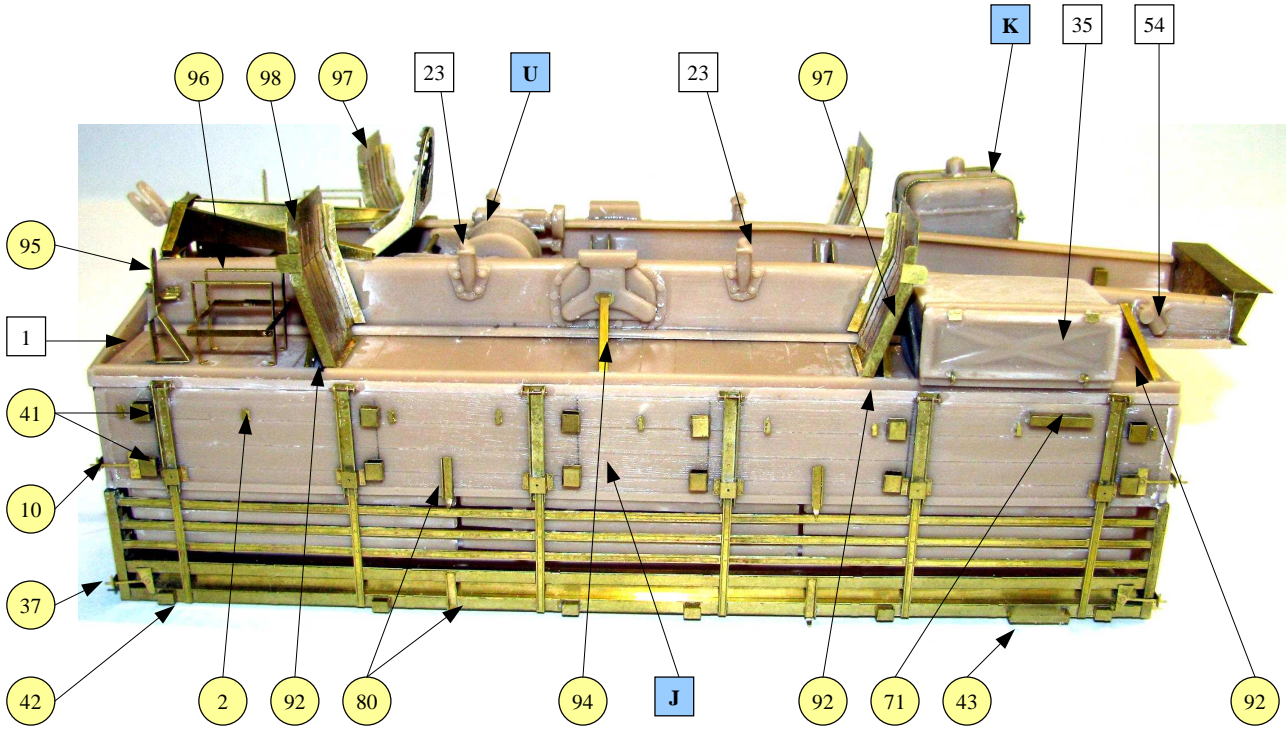
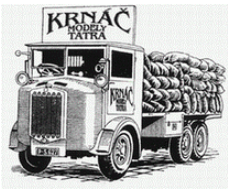

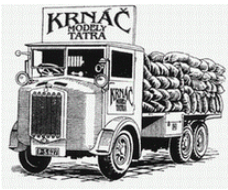

T138-VNM

1/35

35069

17/20

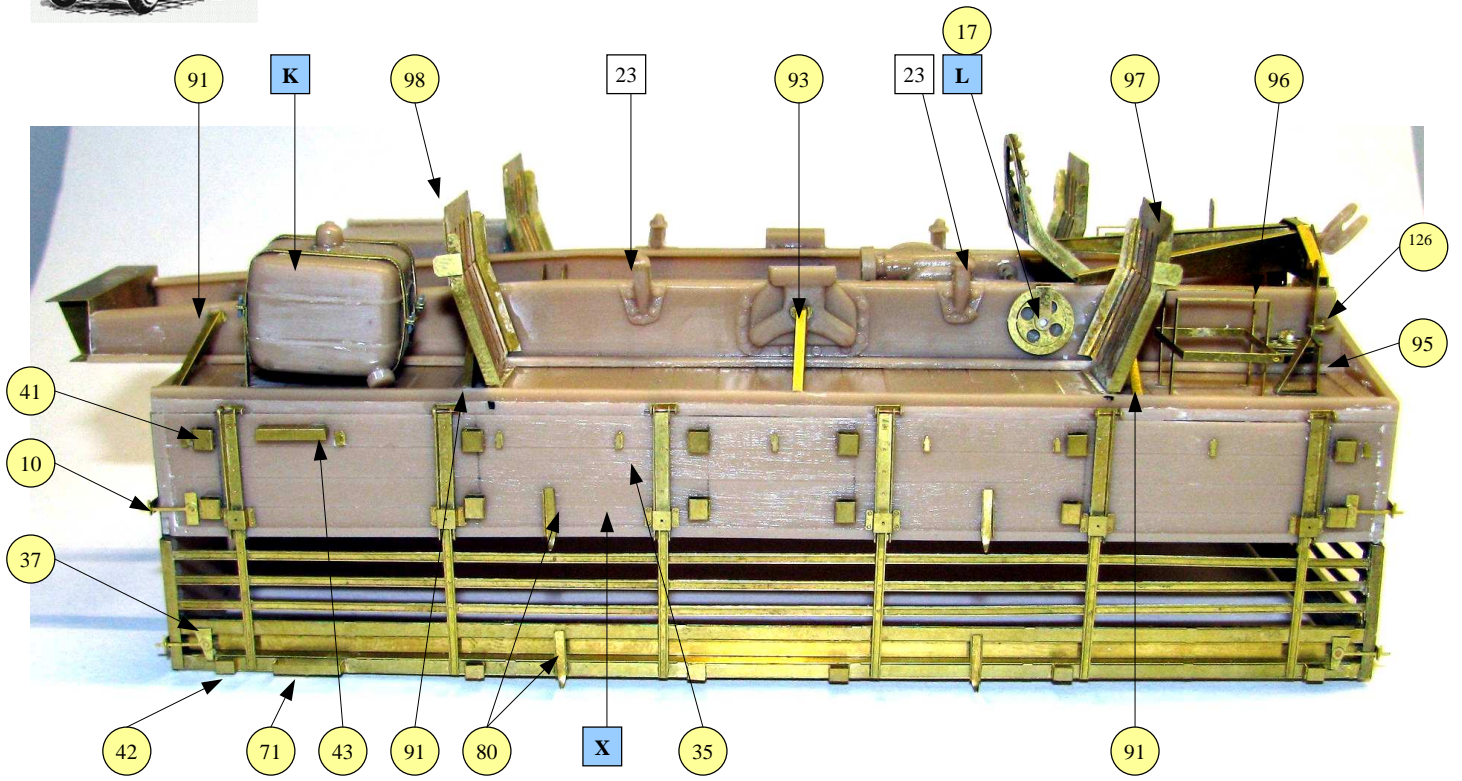

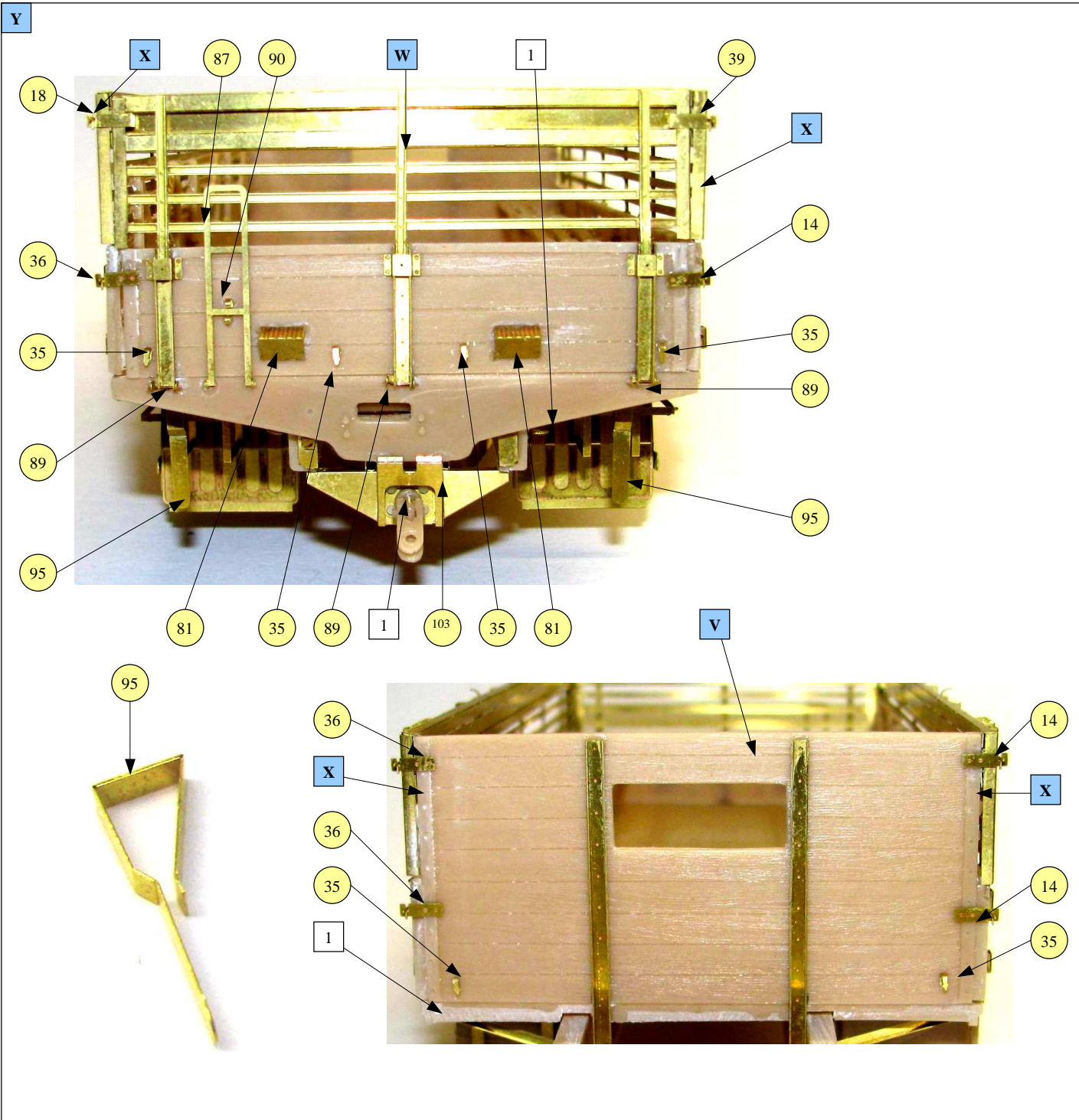

2x 97 / 2x mirrored 98

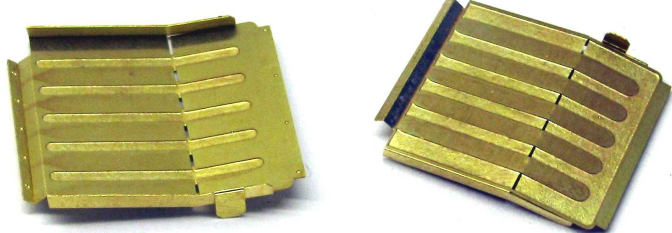

rack for canvas 6x

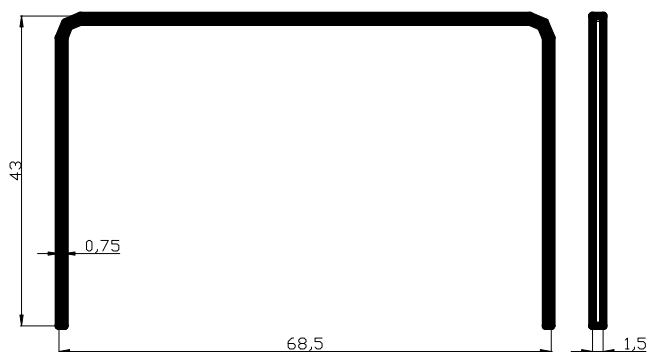

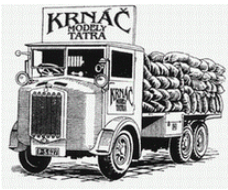

T138-VNM

1/35

35069

19/20

without rack for canvas

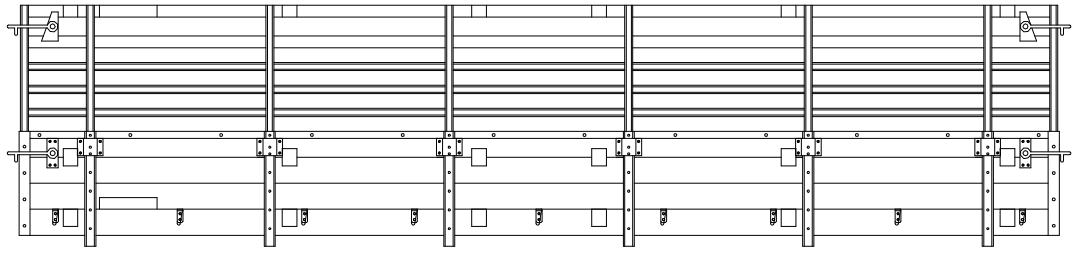

The rack for canvas in transport position

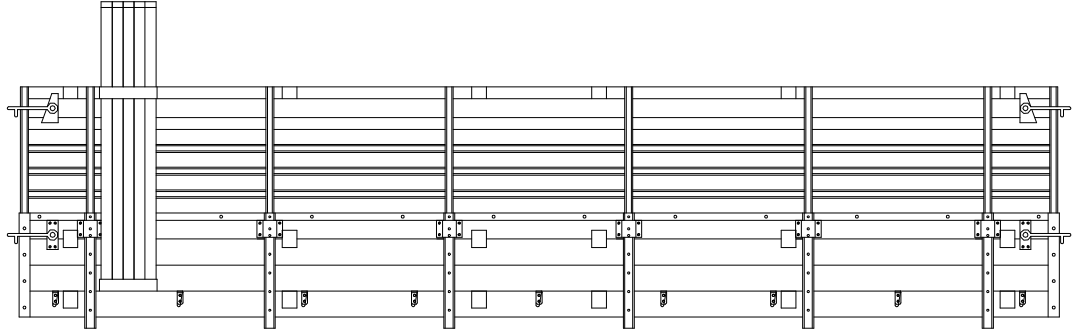

The rack for canvas

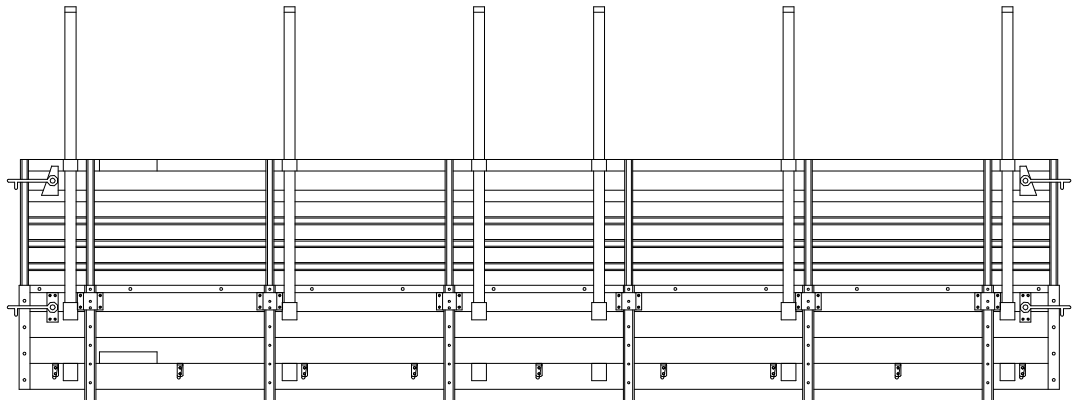



T138-VNM

1/35

35069

20/20

