

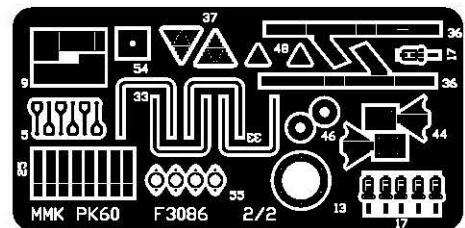

MMK Folknáře 70 40501 Děčín www.mmk.cz mk.model@volny.cz

F 3086 PK 60

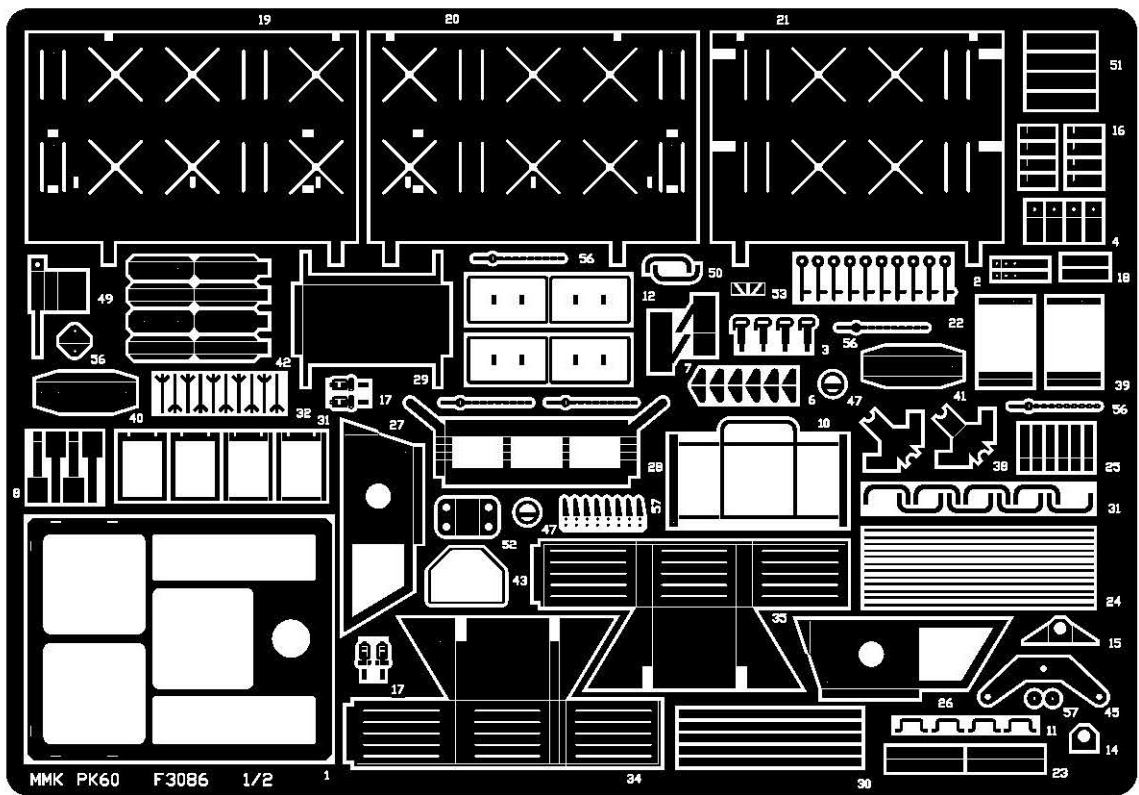

resin parts
 photoetched parts
 not included

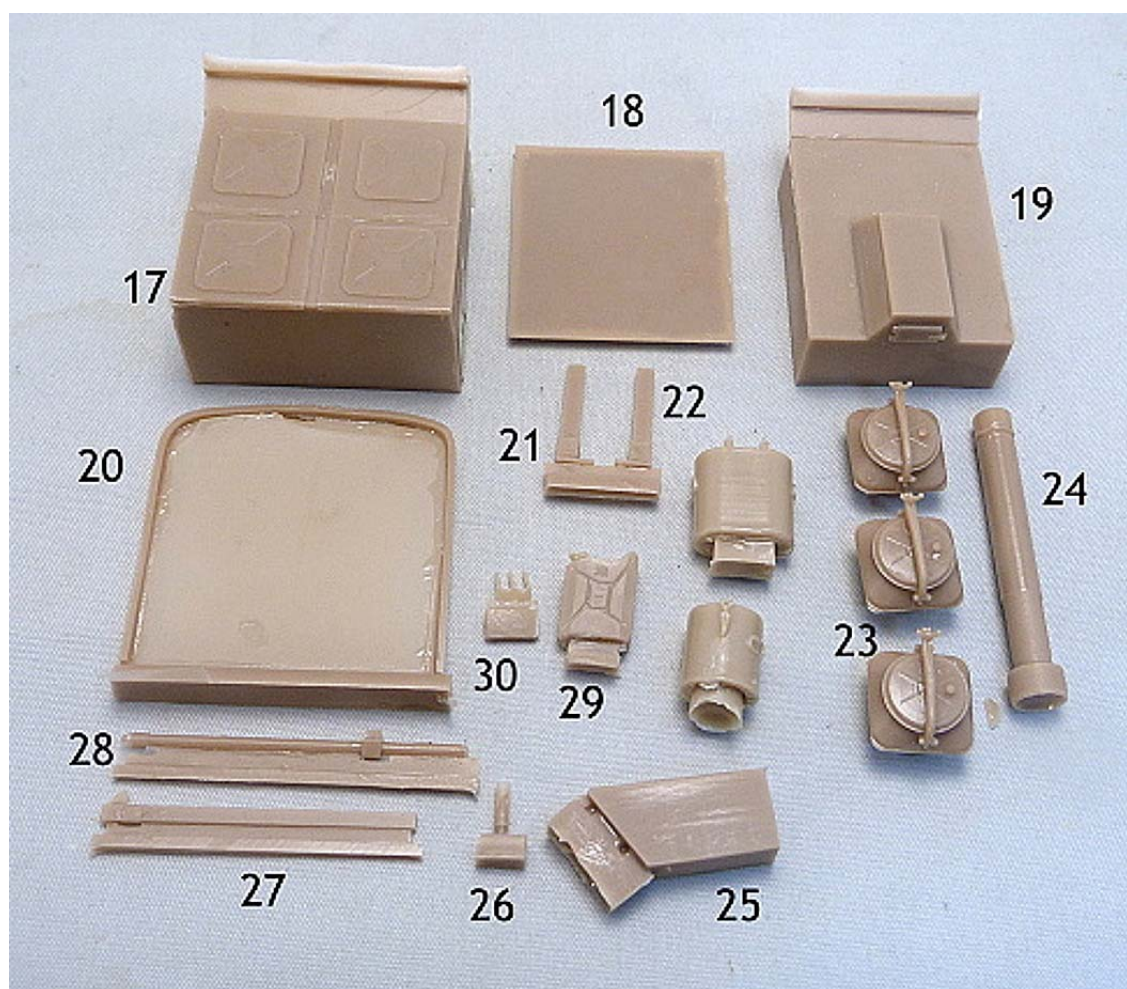
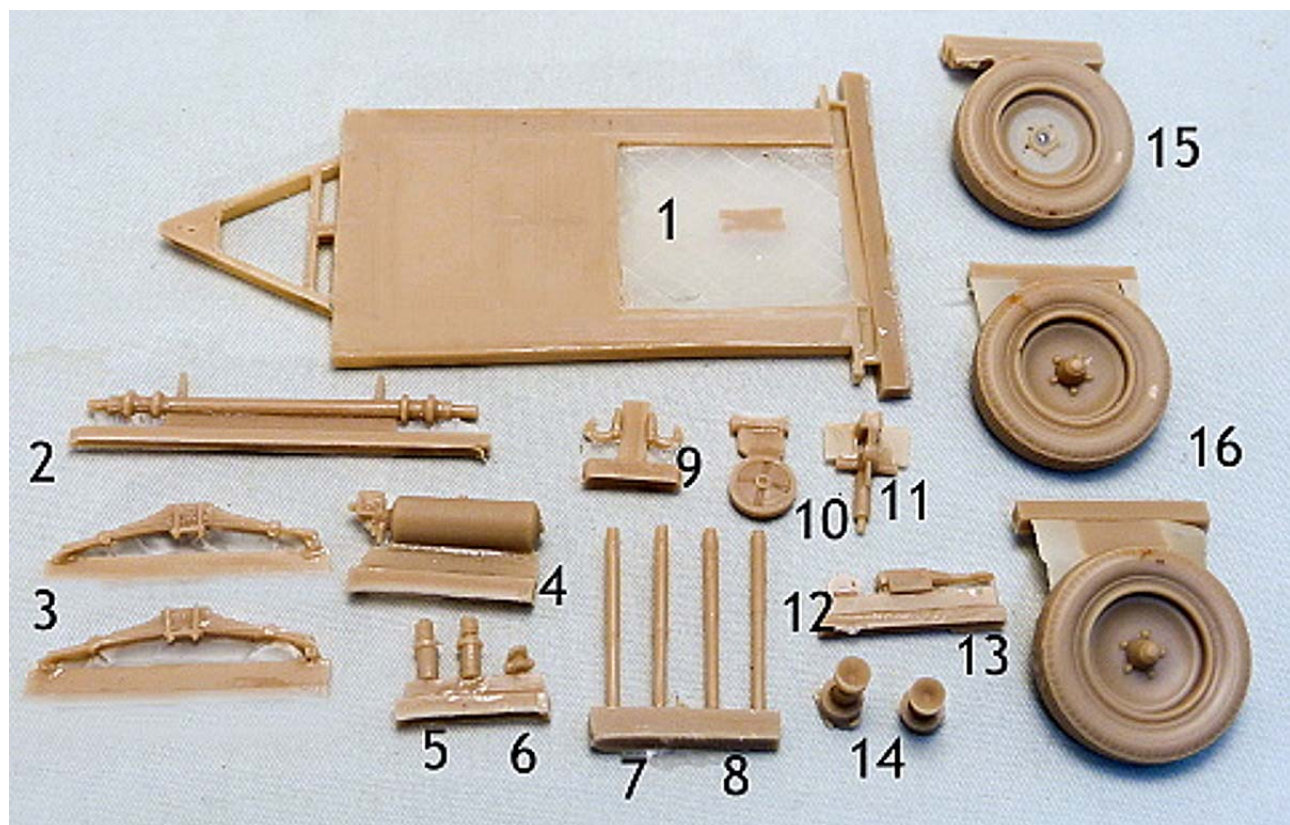

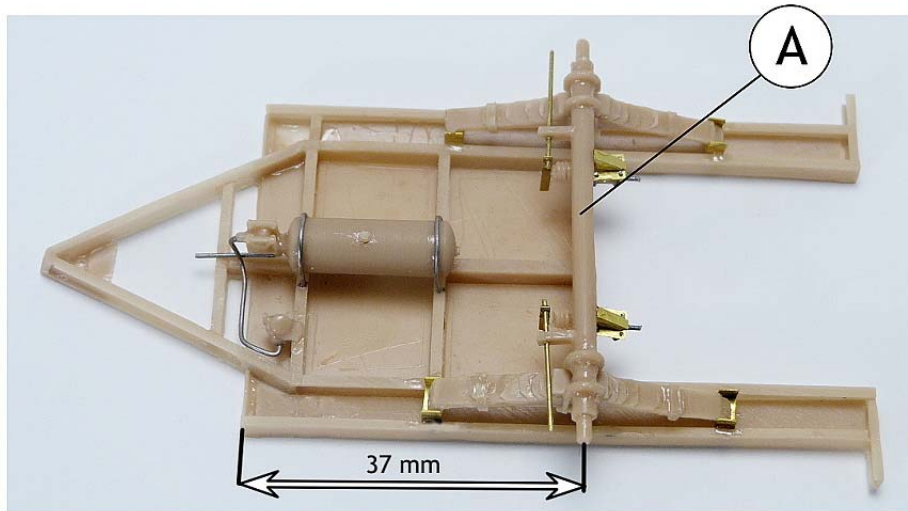
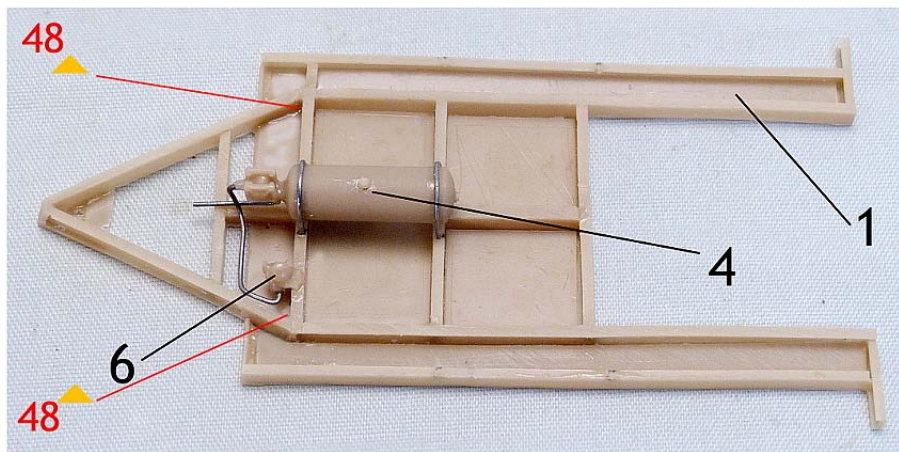
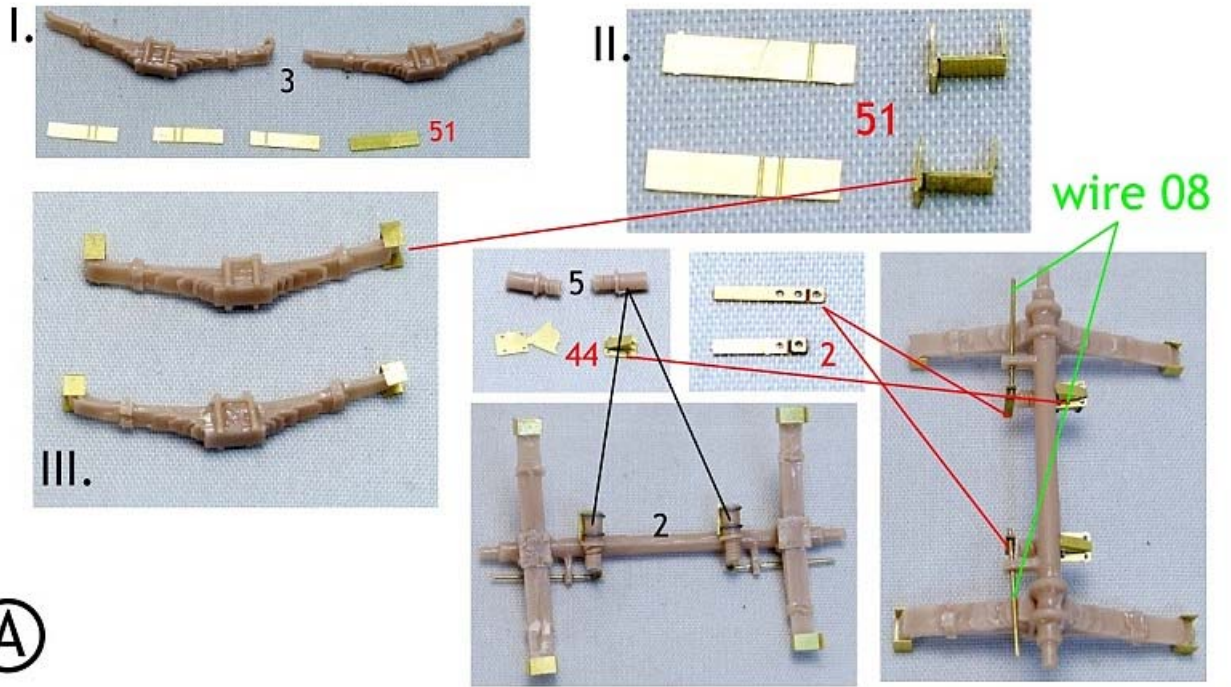

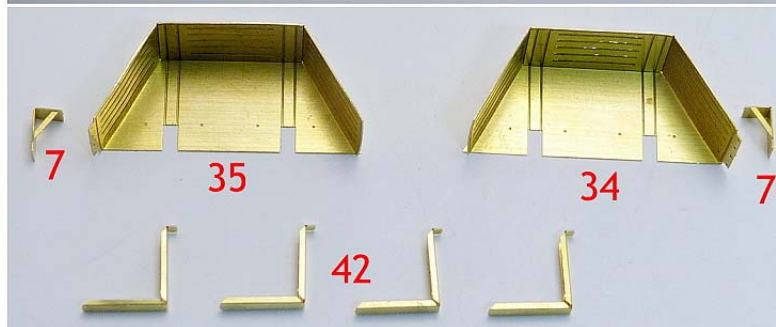
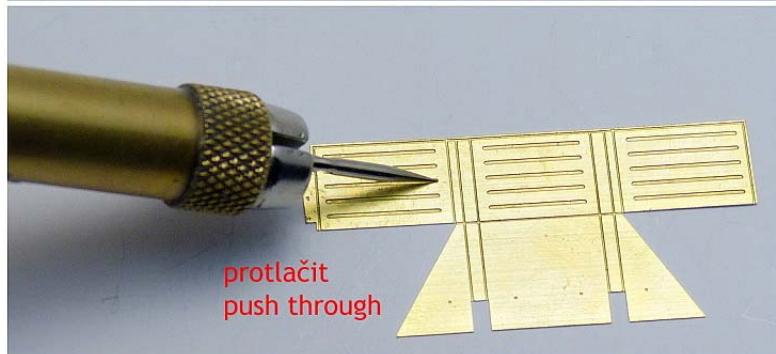
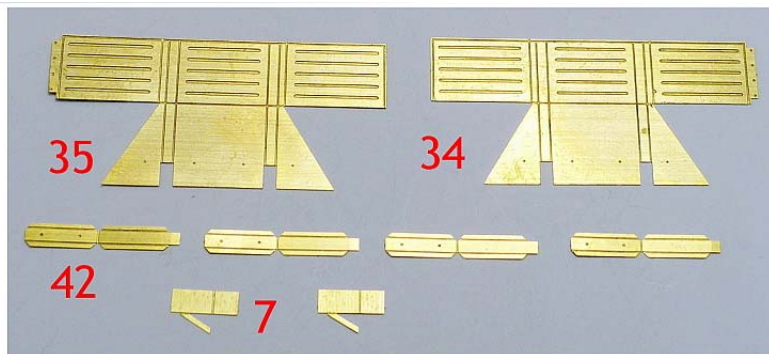
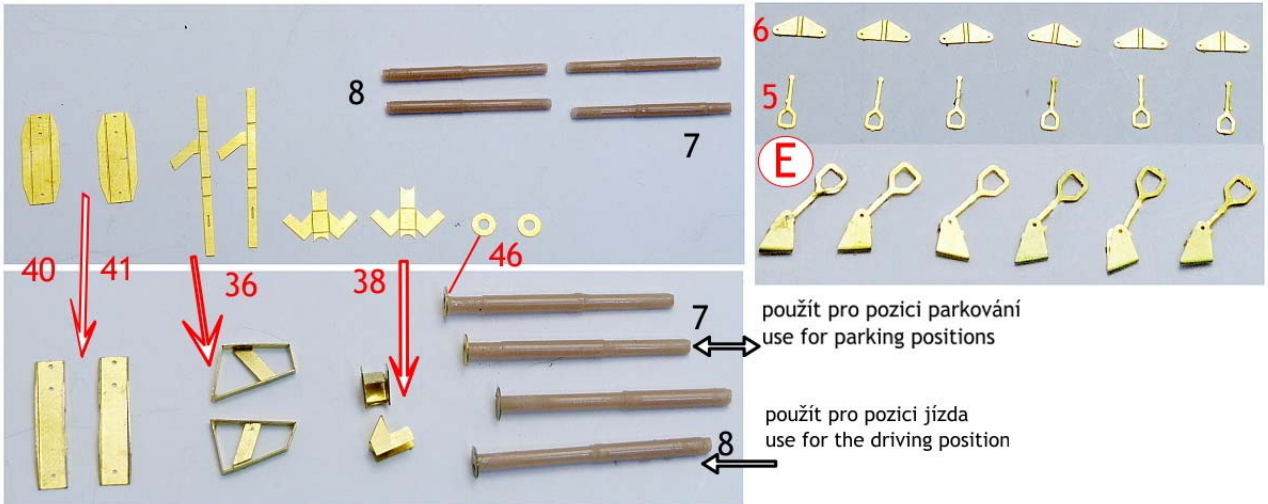
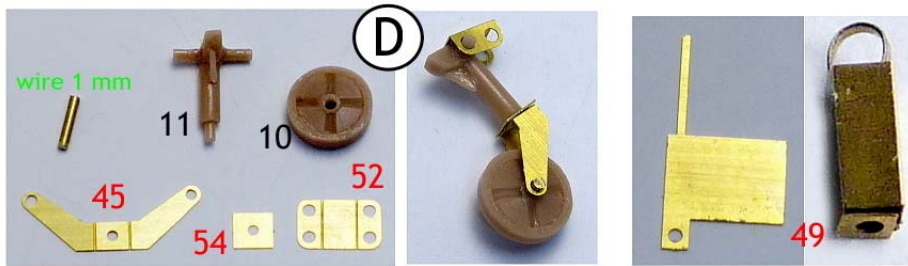

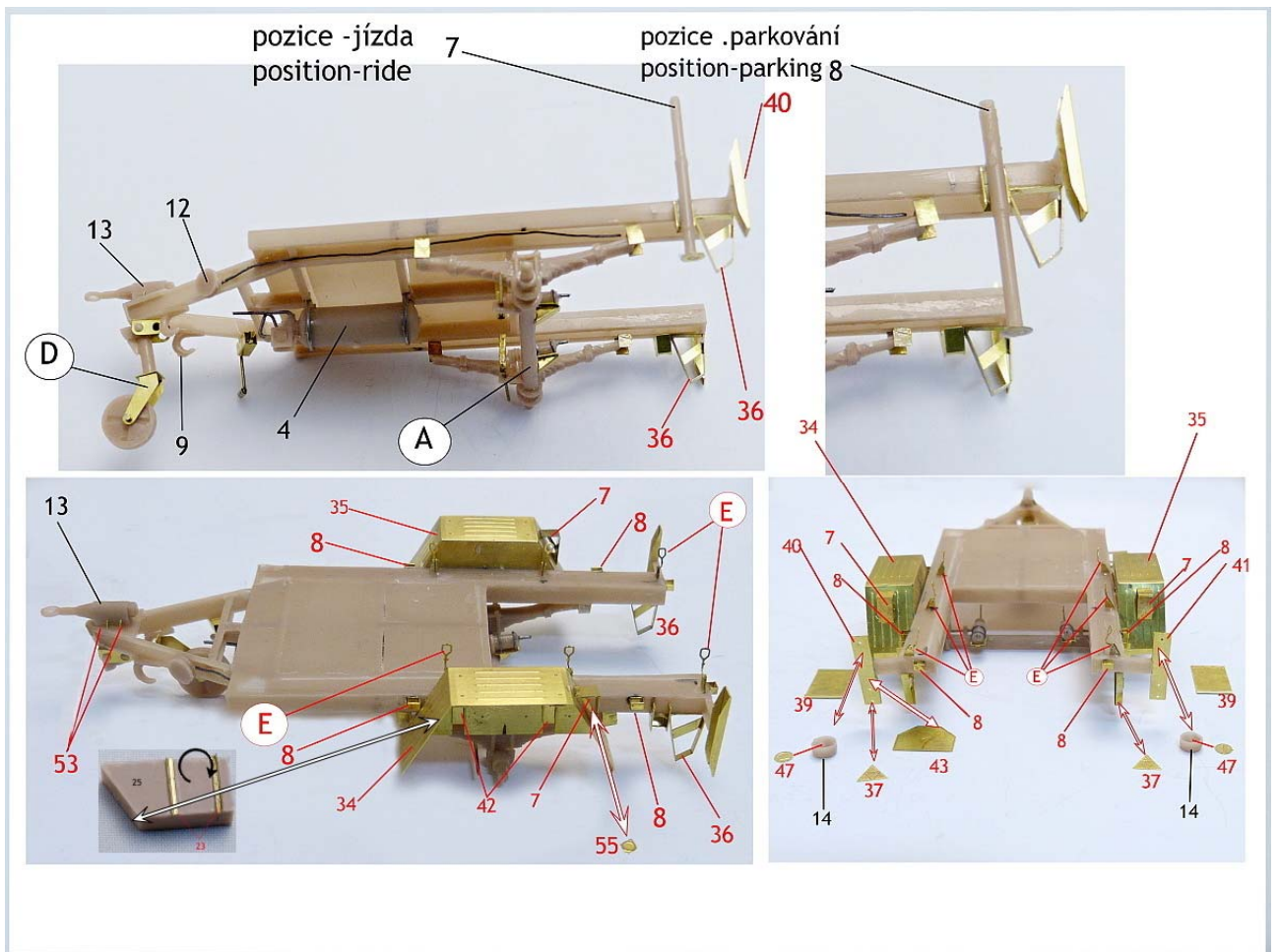
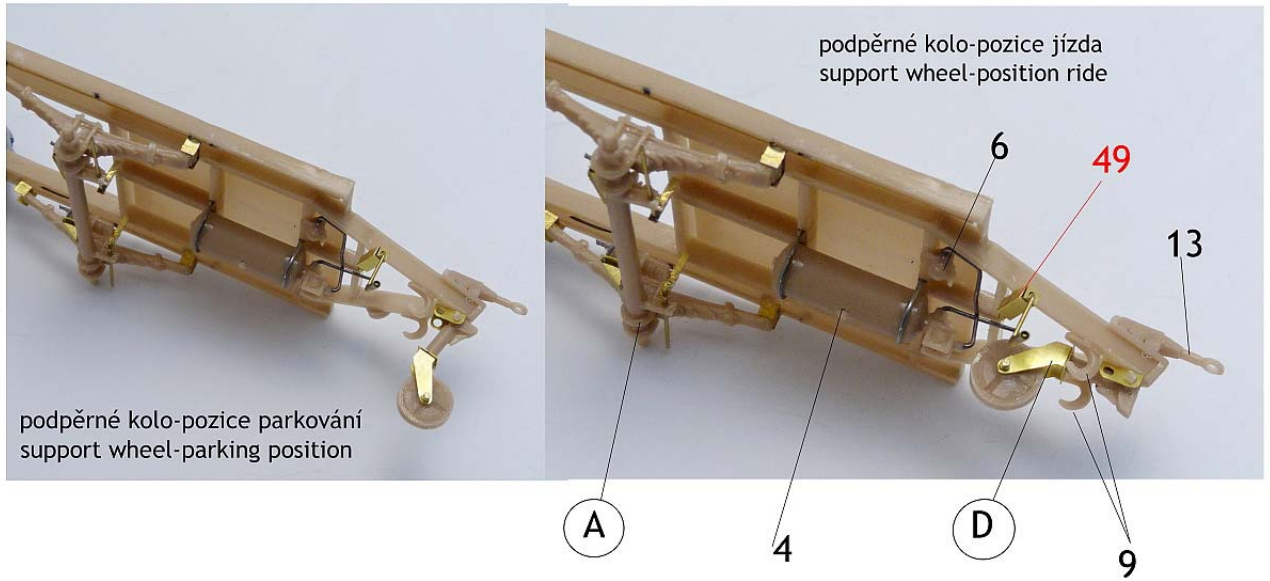

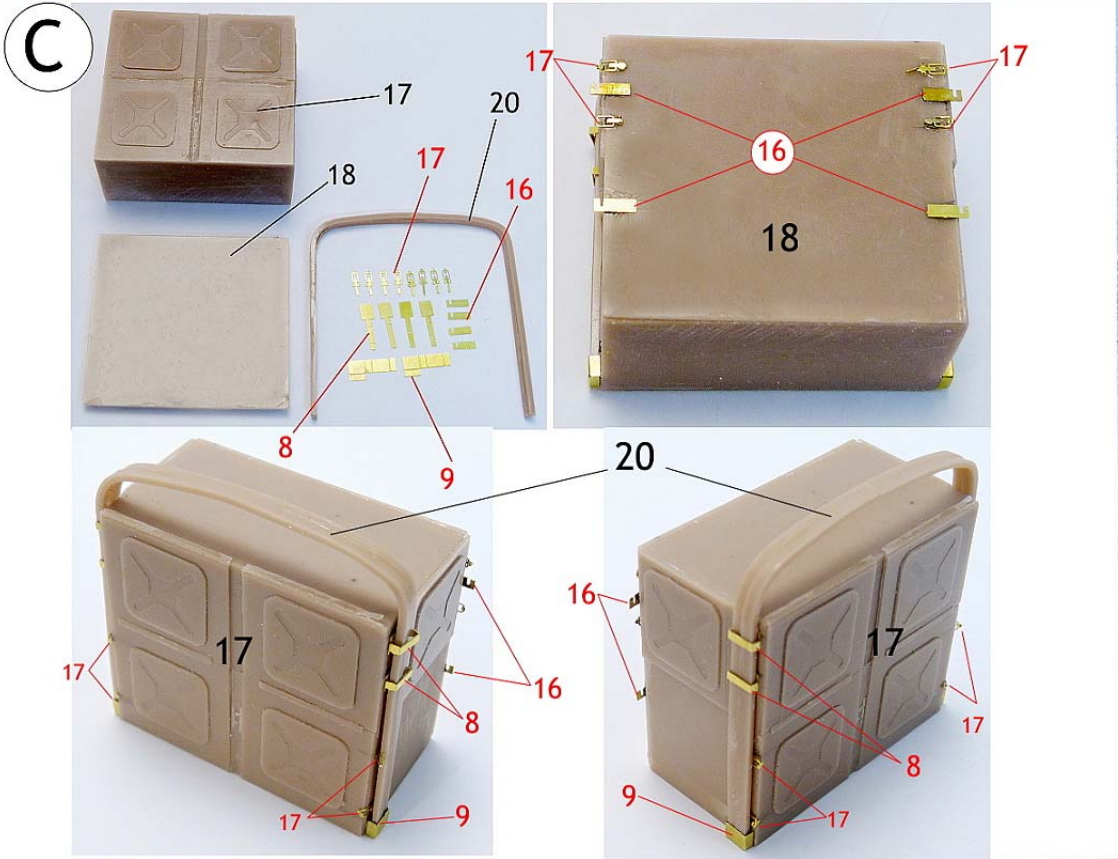
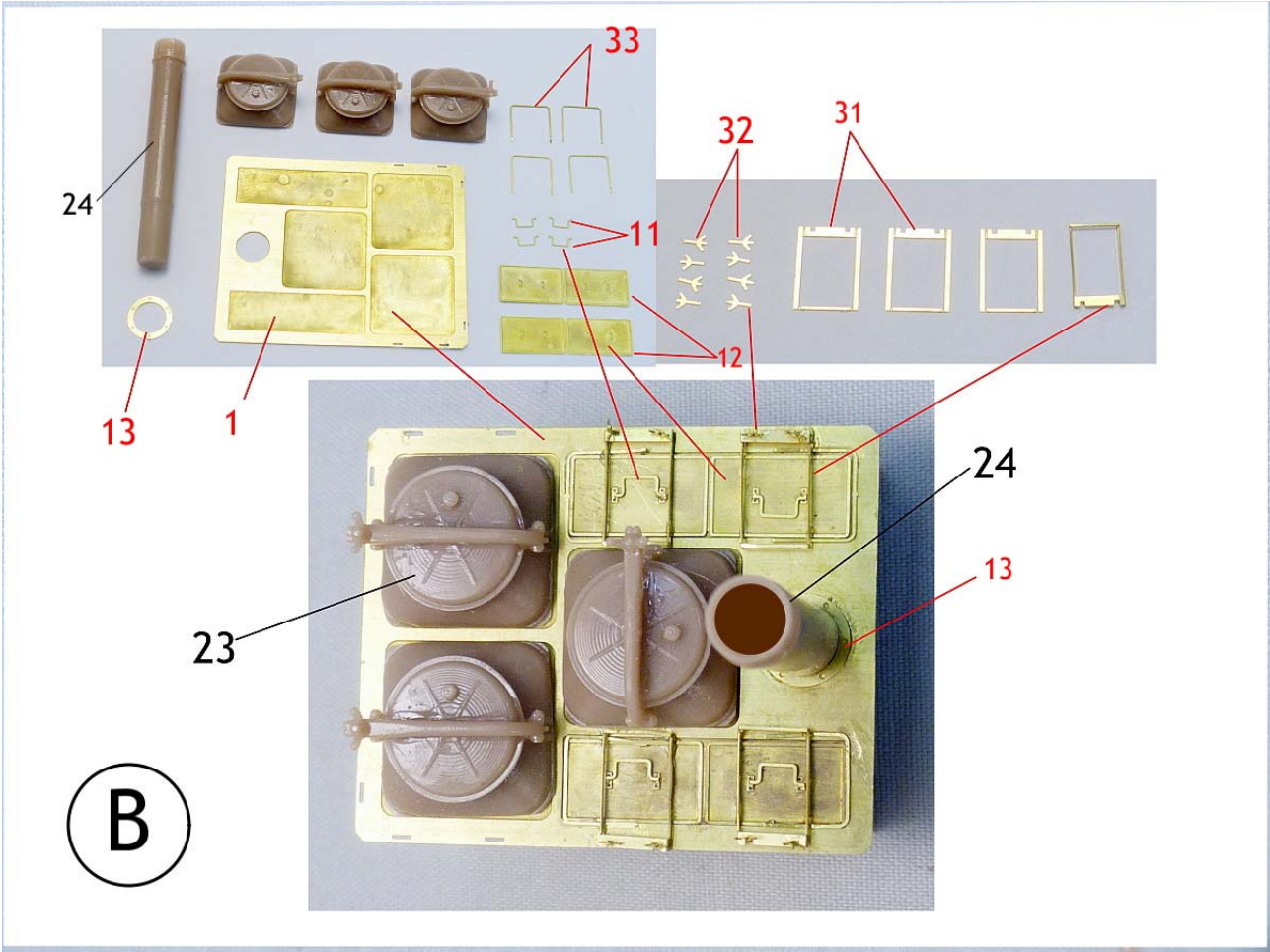

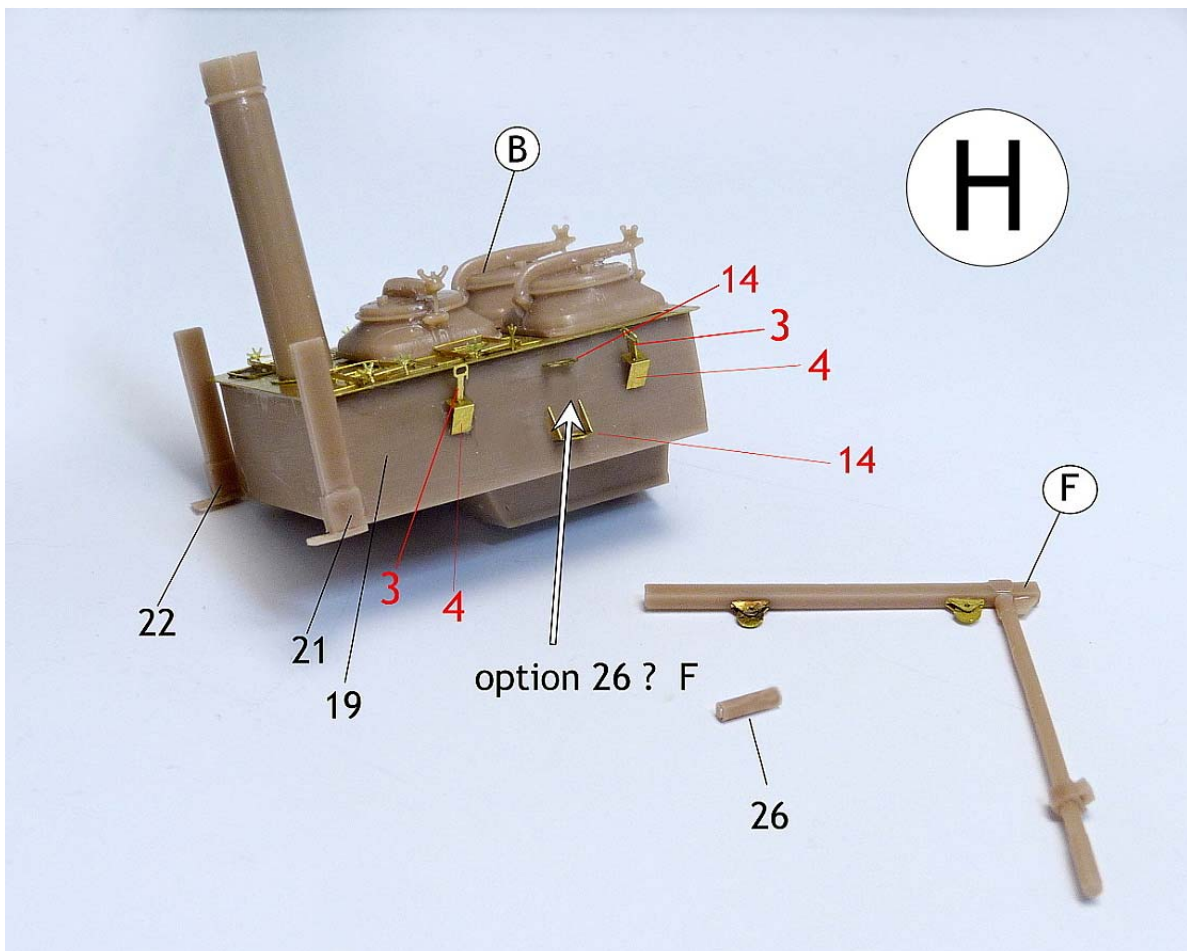
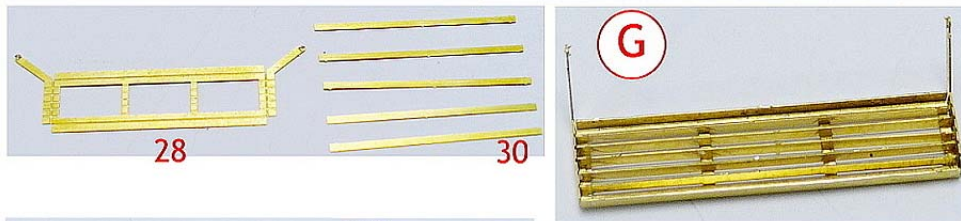
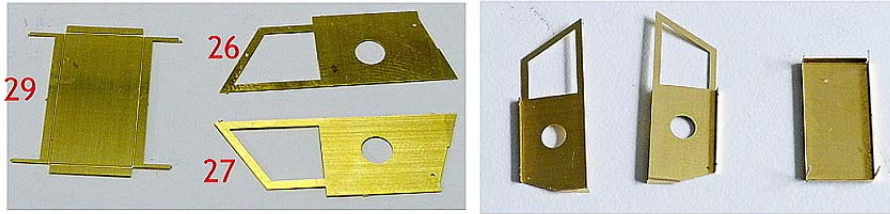
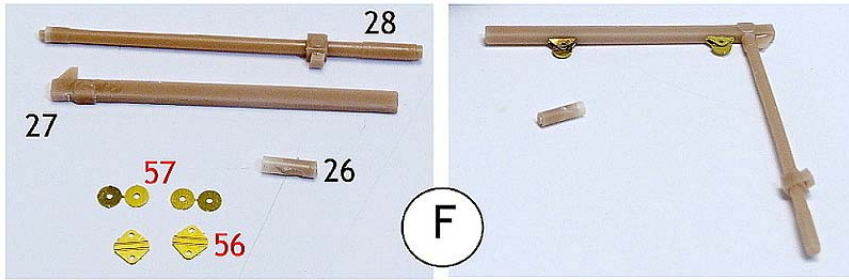

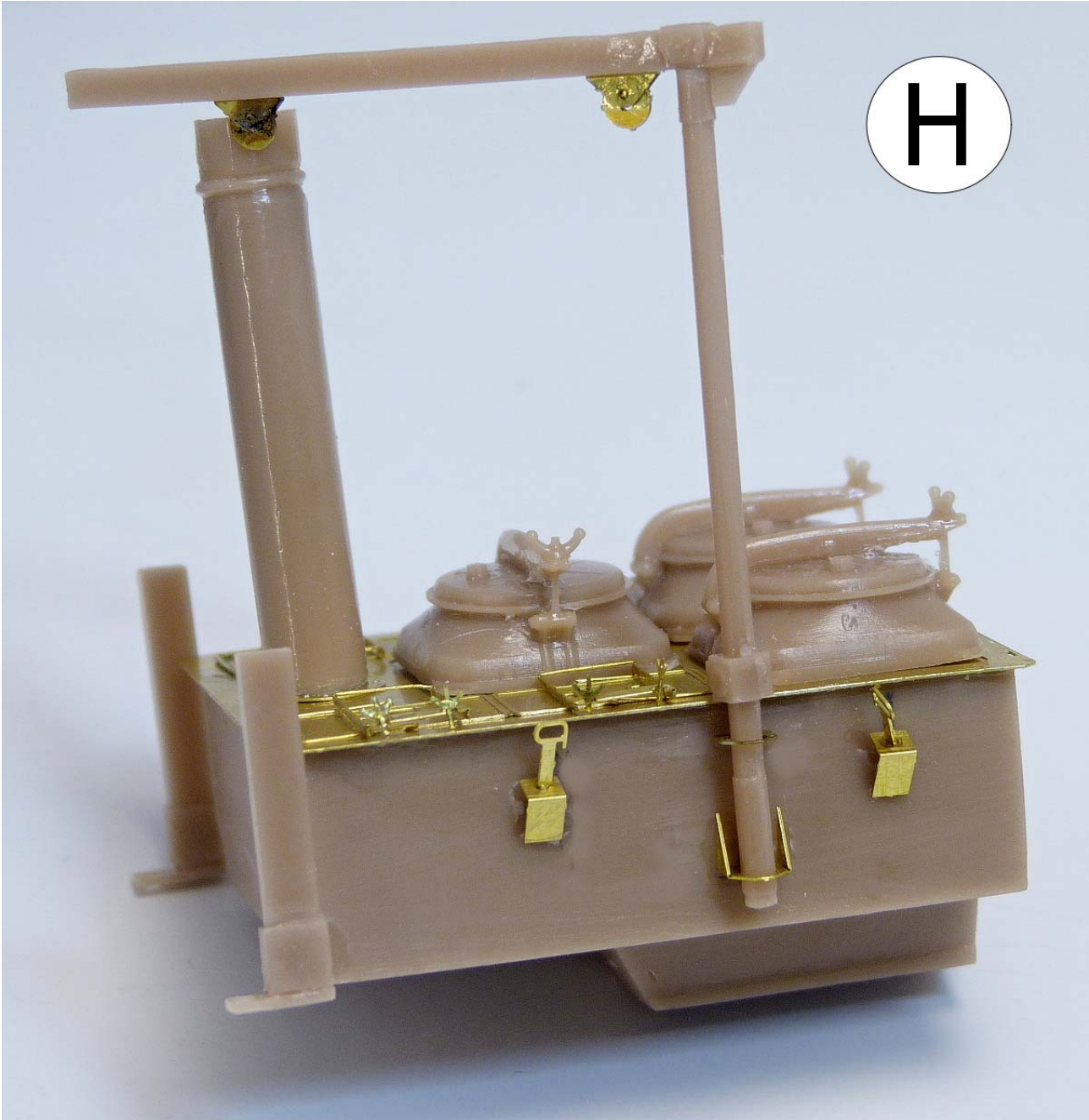

H

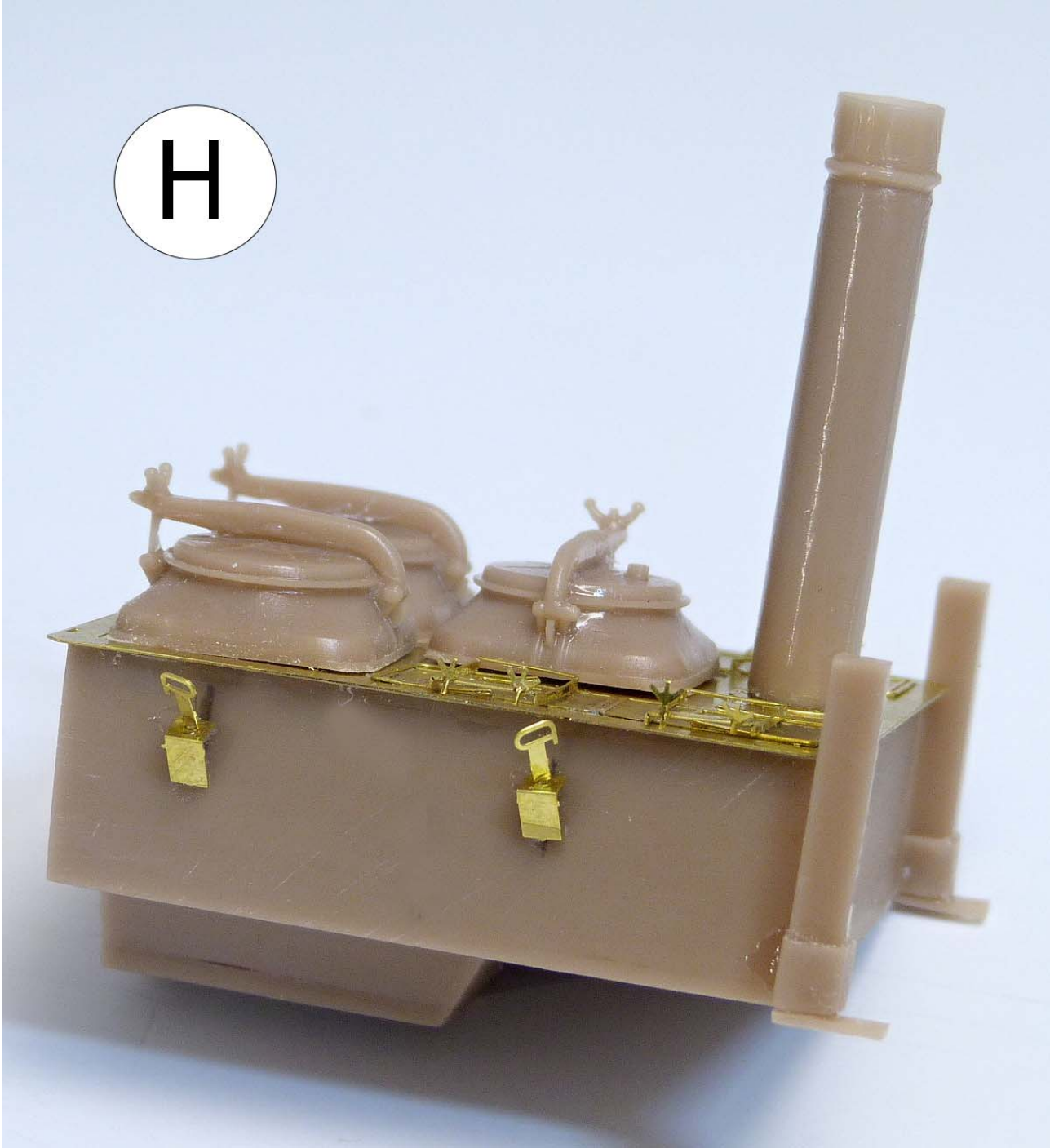

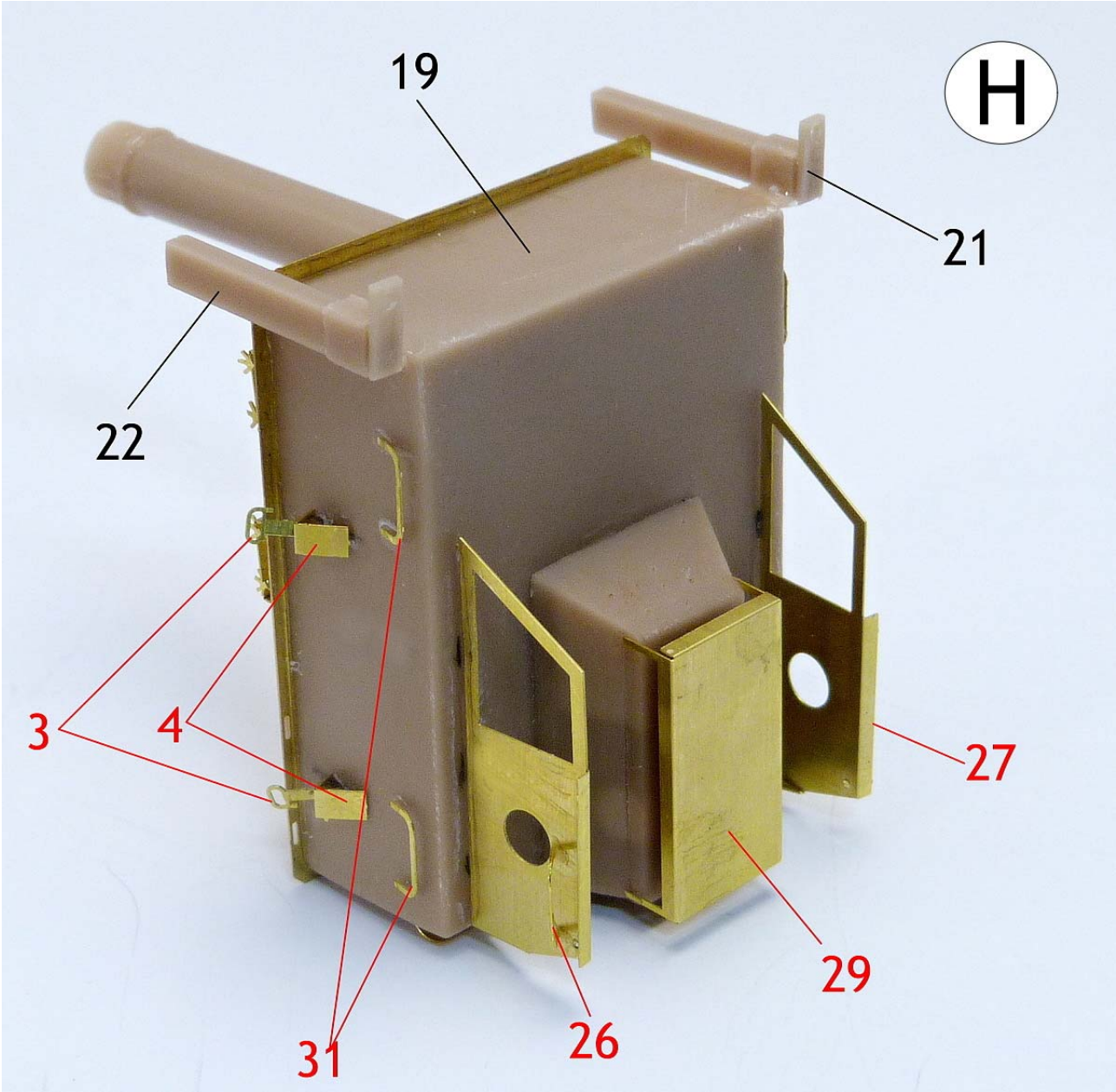

H

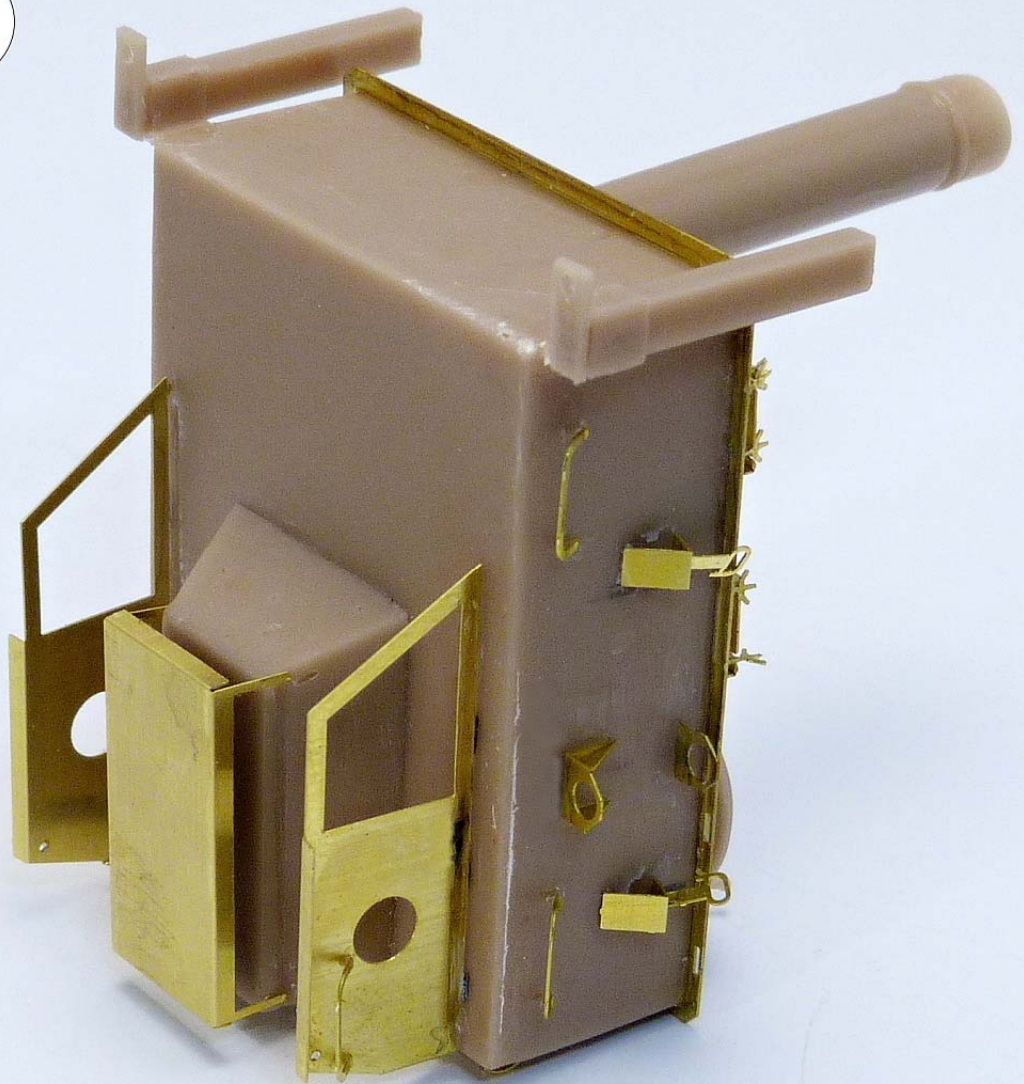

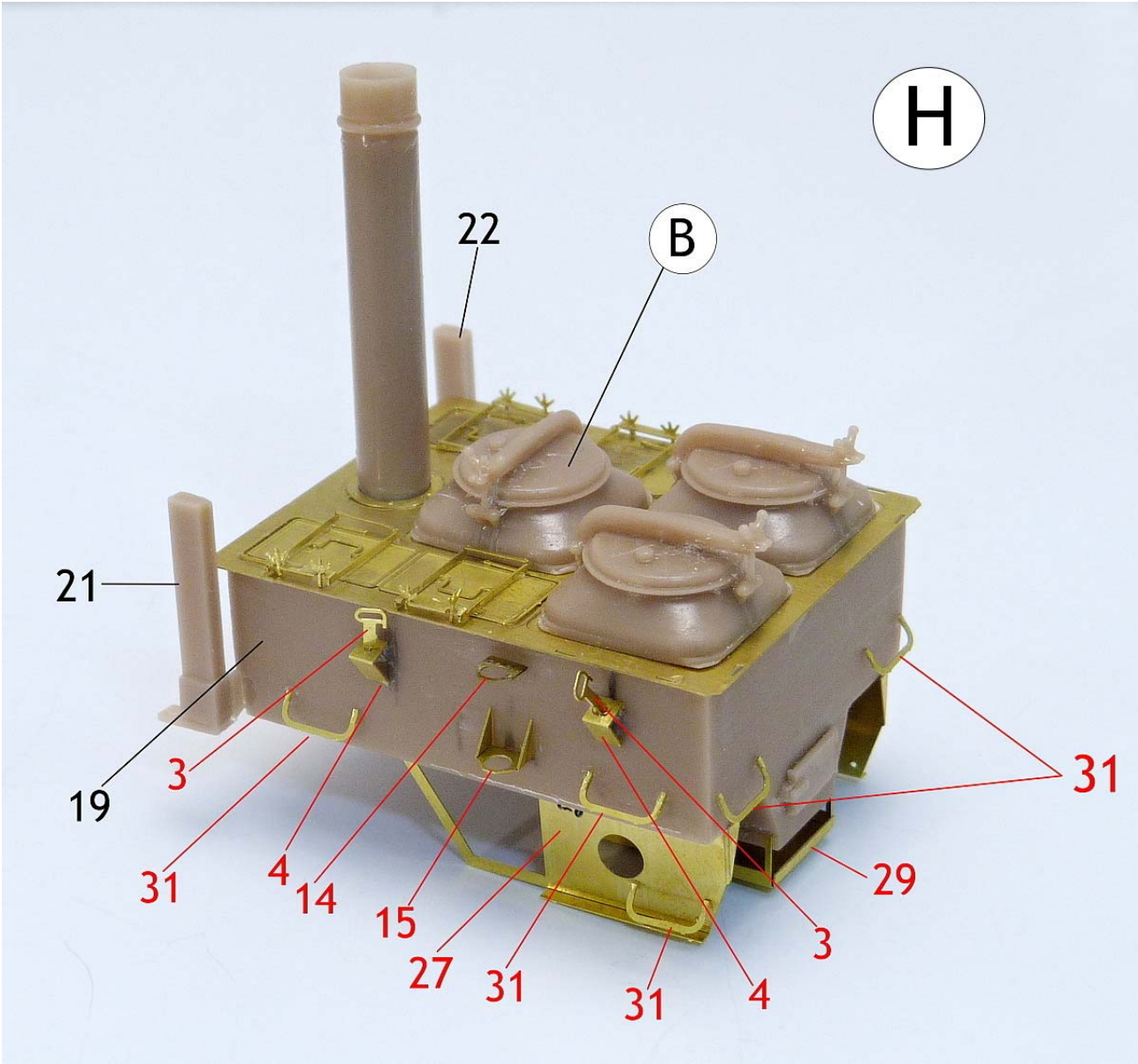

H

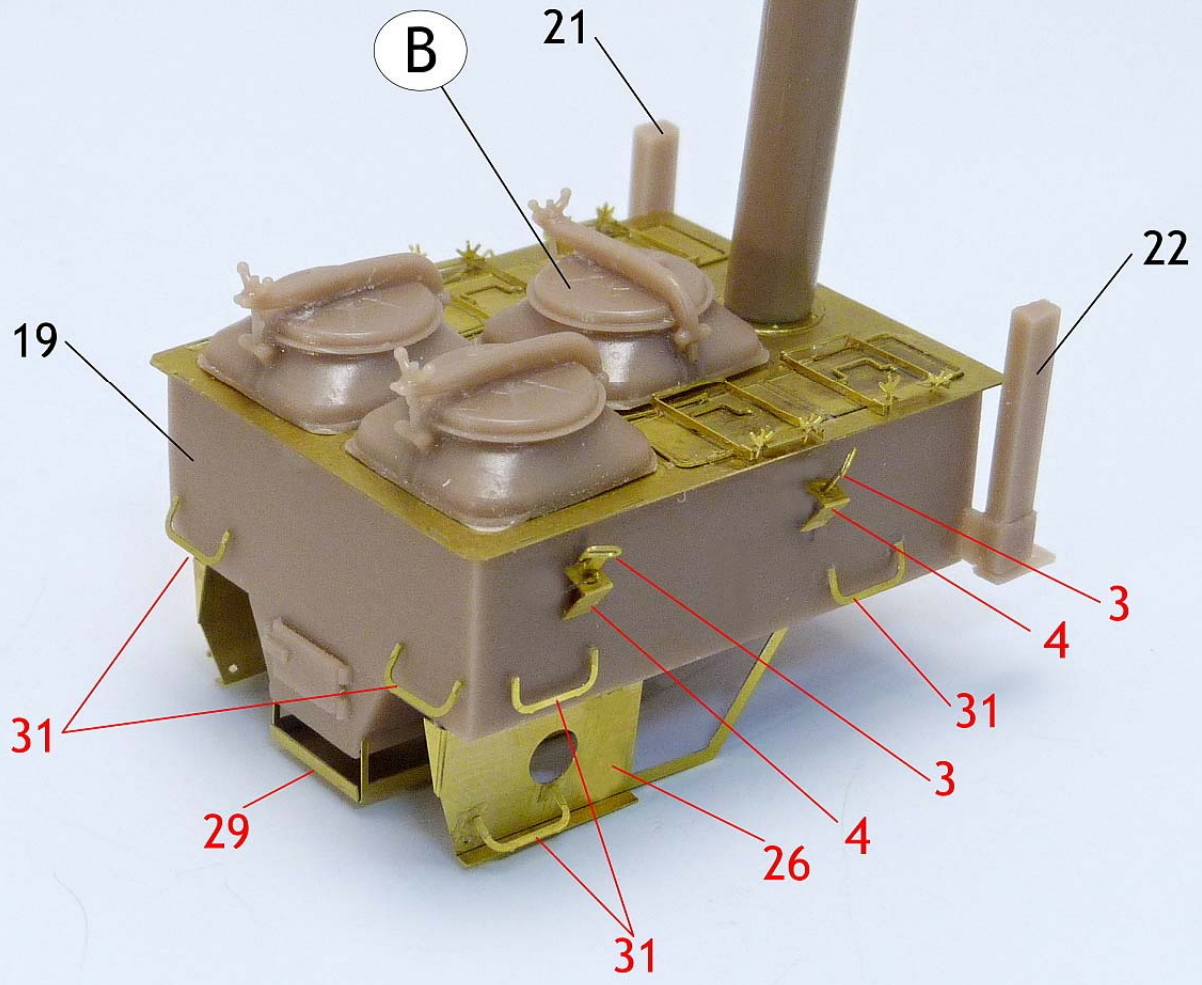

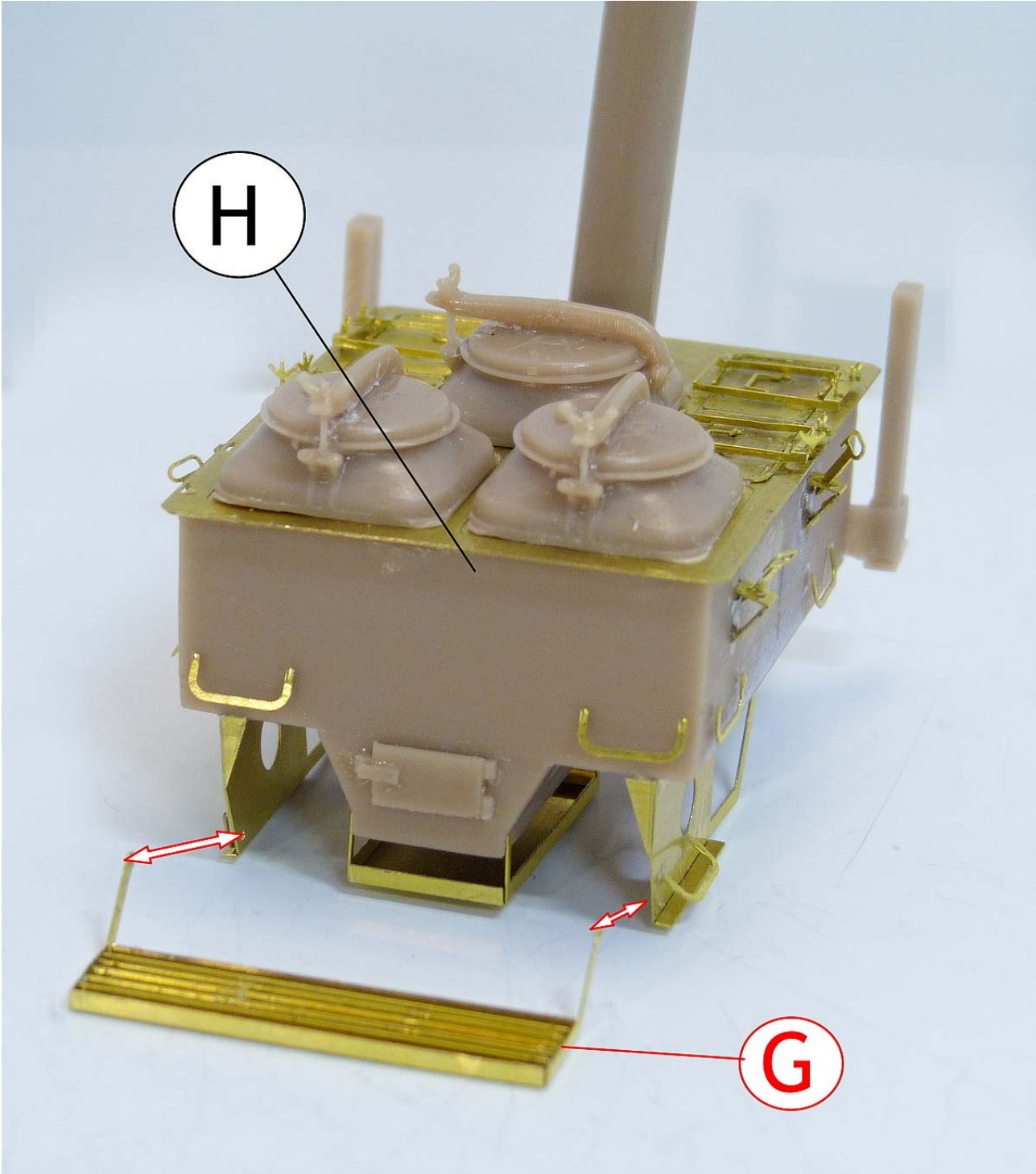

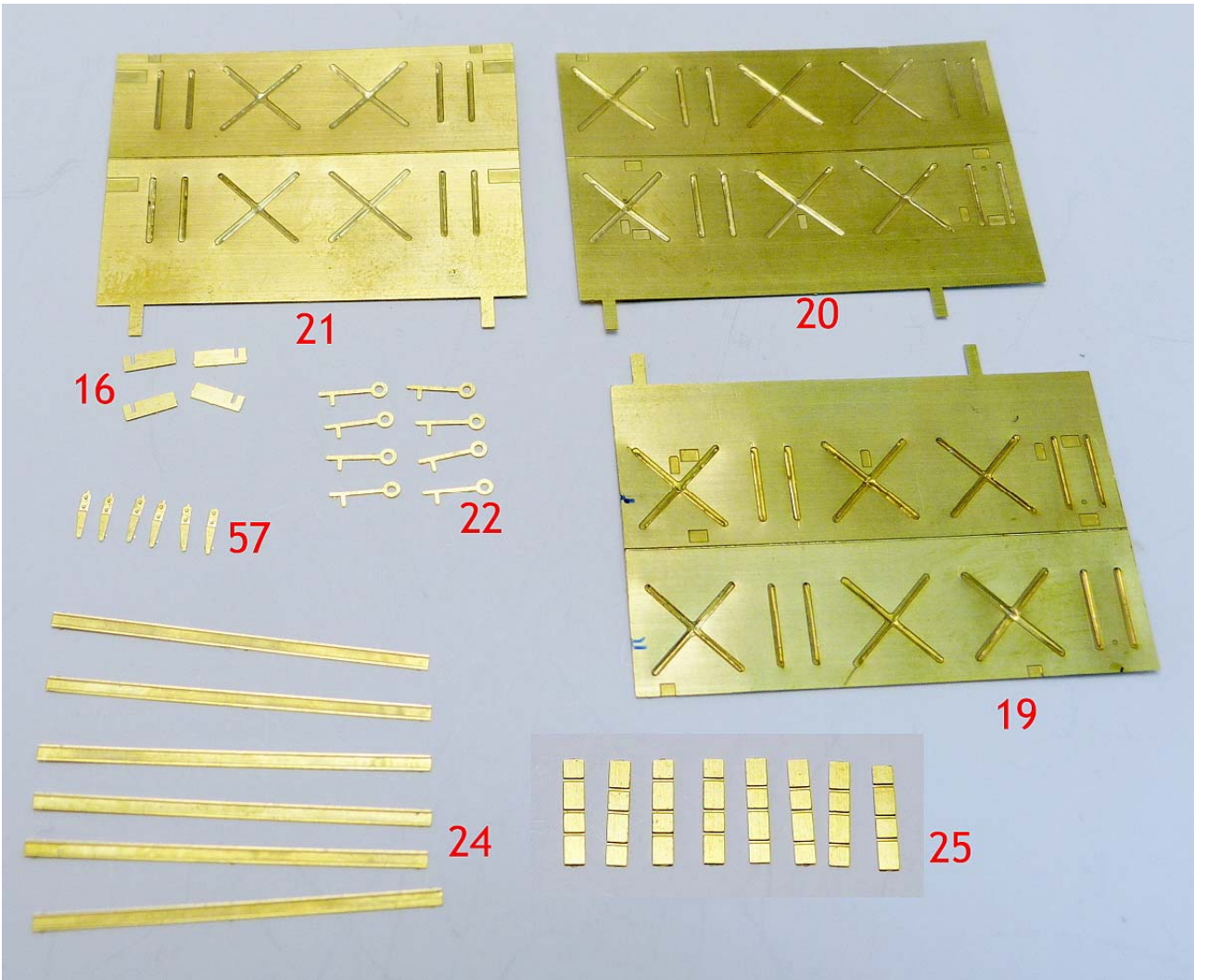

protlačit
 push trough

