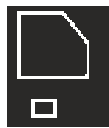
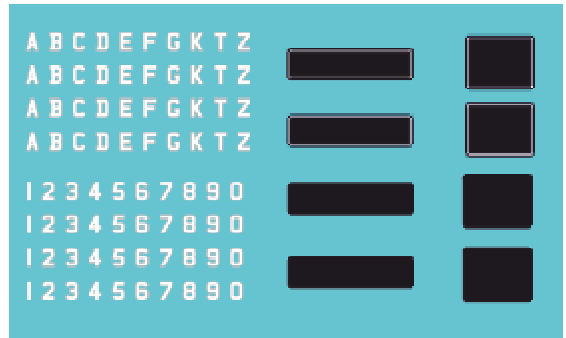

PHOTO-ETCHED PARTS



FILM



DECALS

RESIN PARTS

xx

PHOTO-ETCHED PARTS F3054

xx

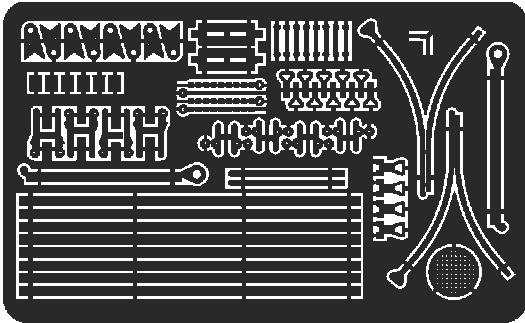
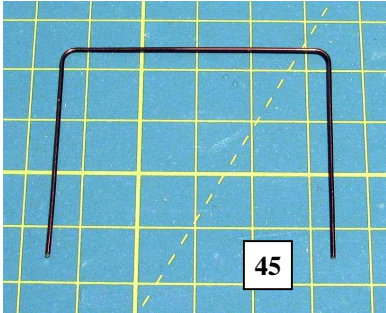
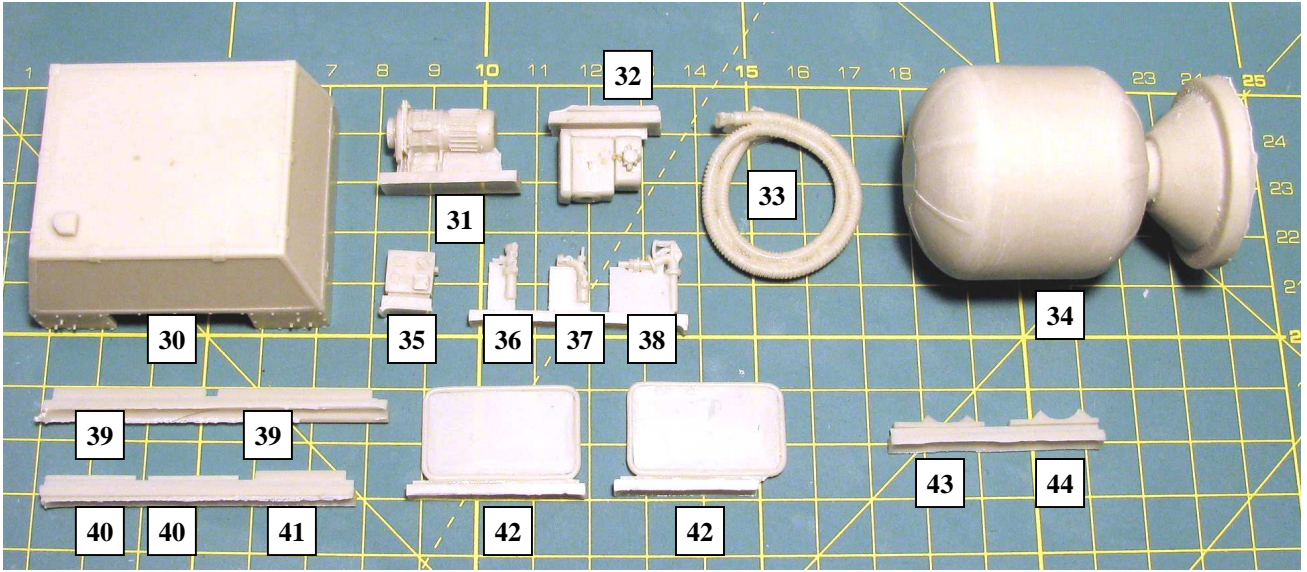

PHOTO-ETCHED PARTS F3065

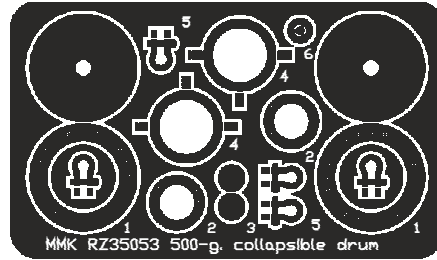

PHOTO-ETCHED PARTS RZ35053

RESIN PARTS

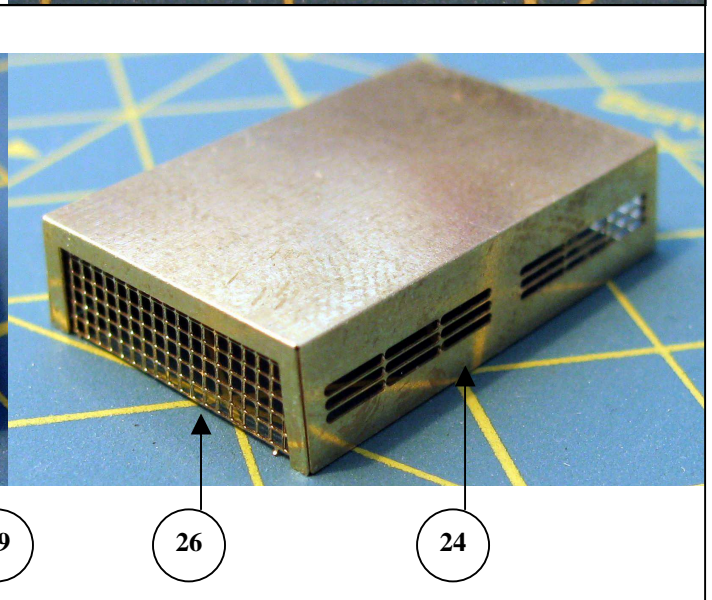
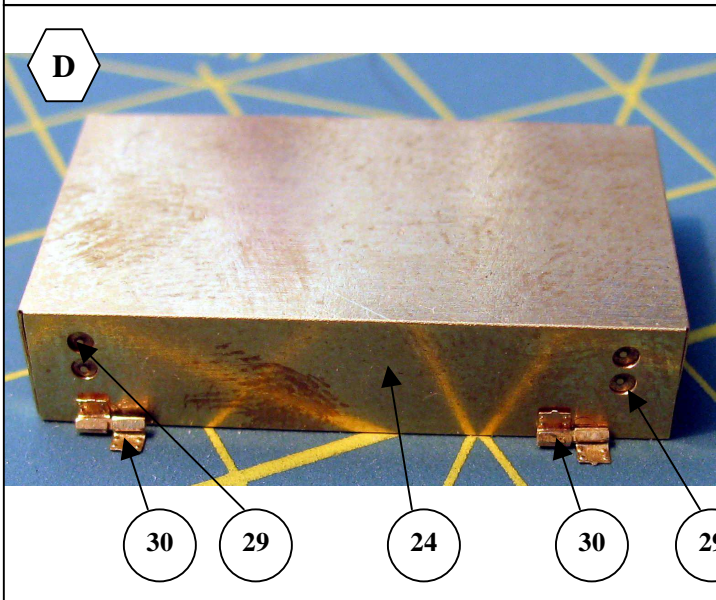
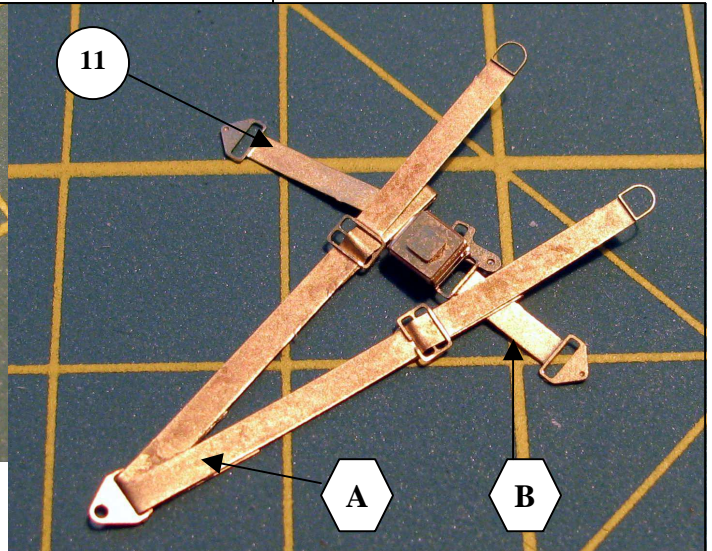
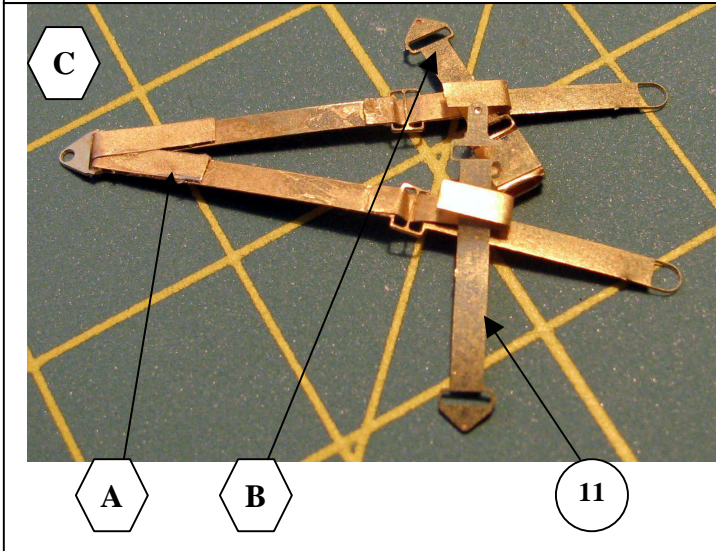
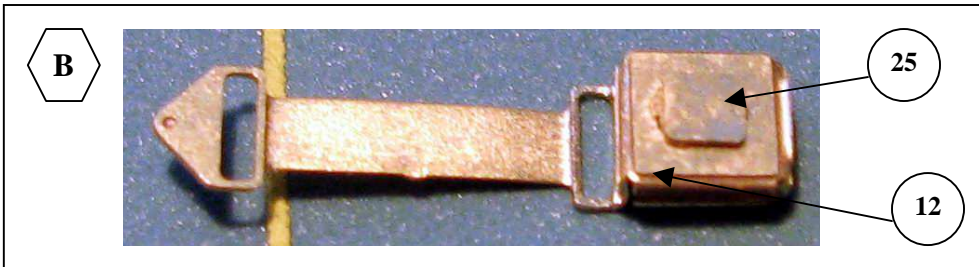
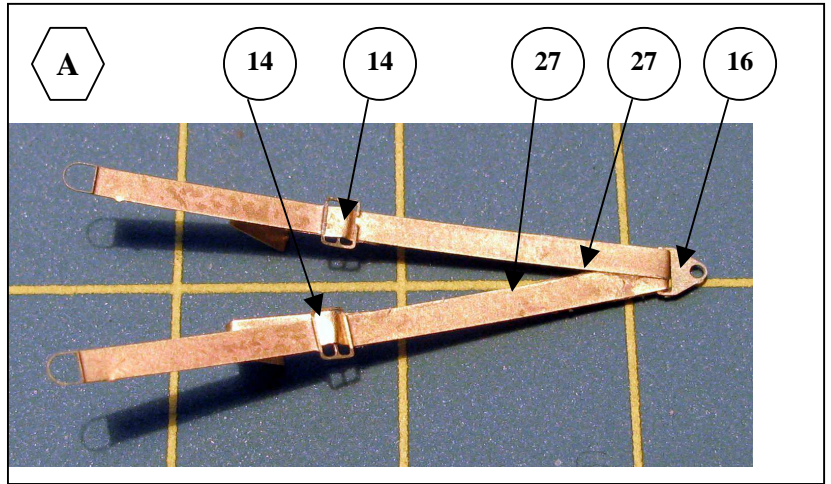

PHOTO-ETCHED PARTS F3065



PHOTO-ETCHED PARTS RZ35053





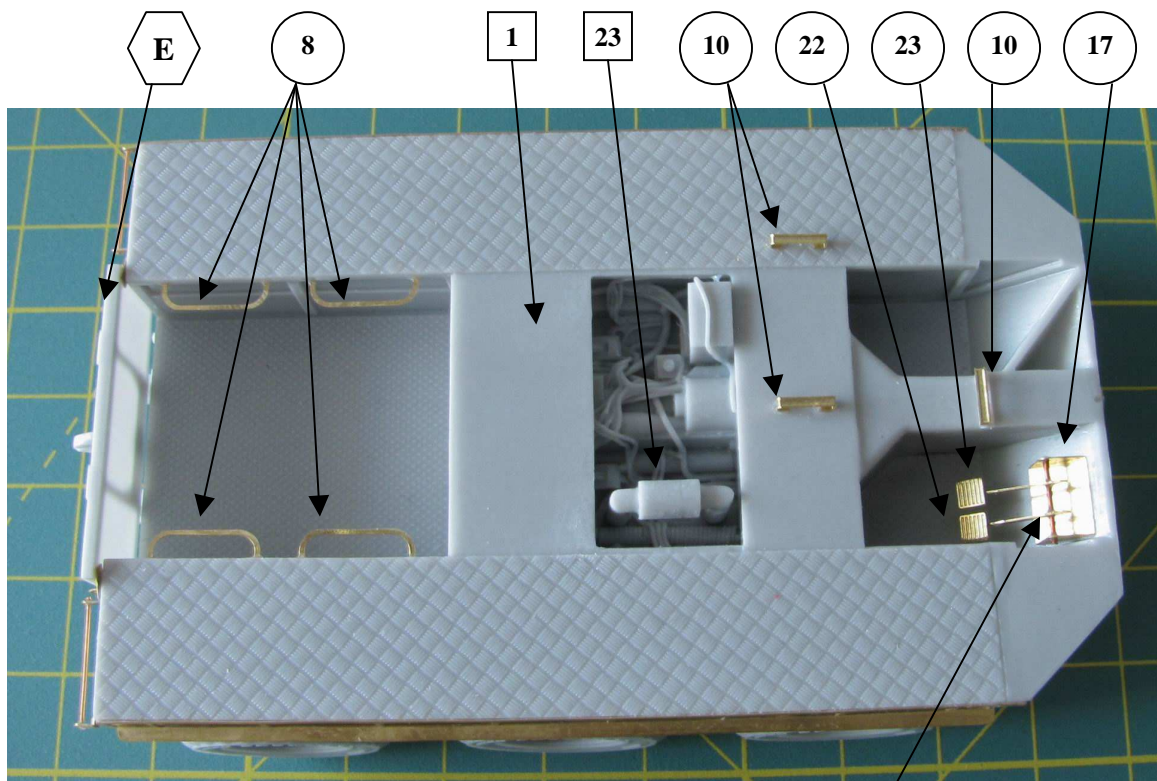
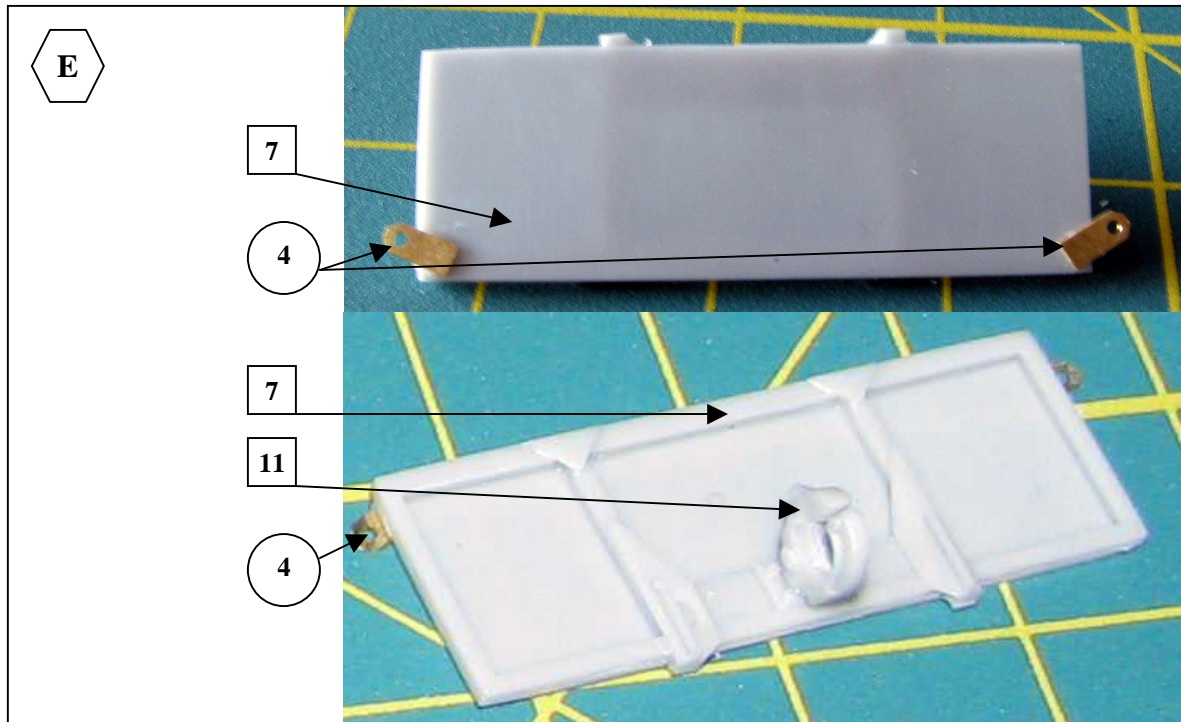

WIRE  $\varnothing 0,5 - 8mm$



Supacat ATMP with Collapsible Fuel Drum 1/35

F3065  
5/16

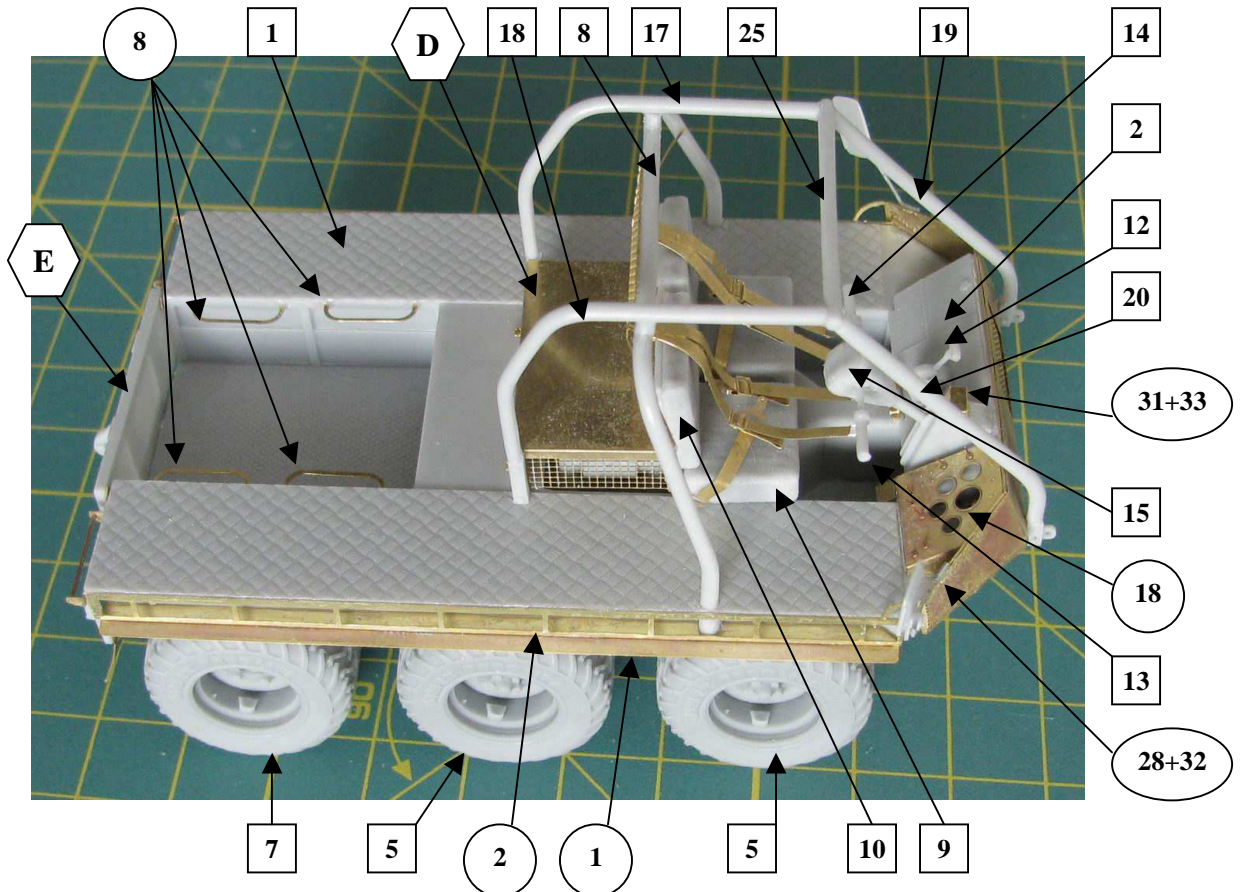
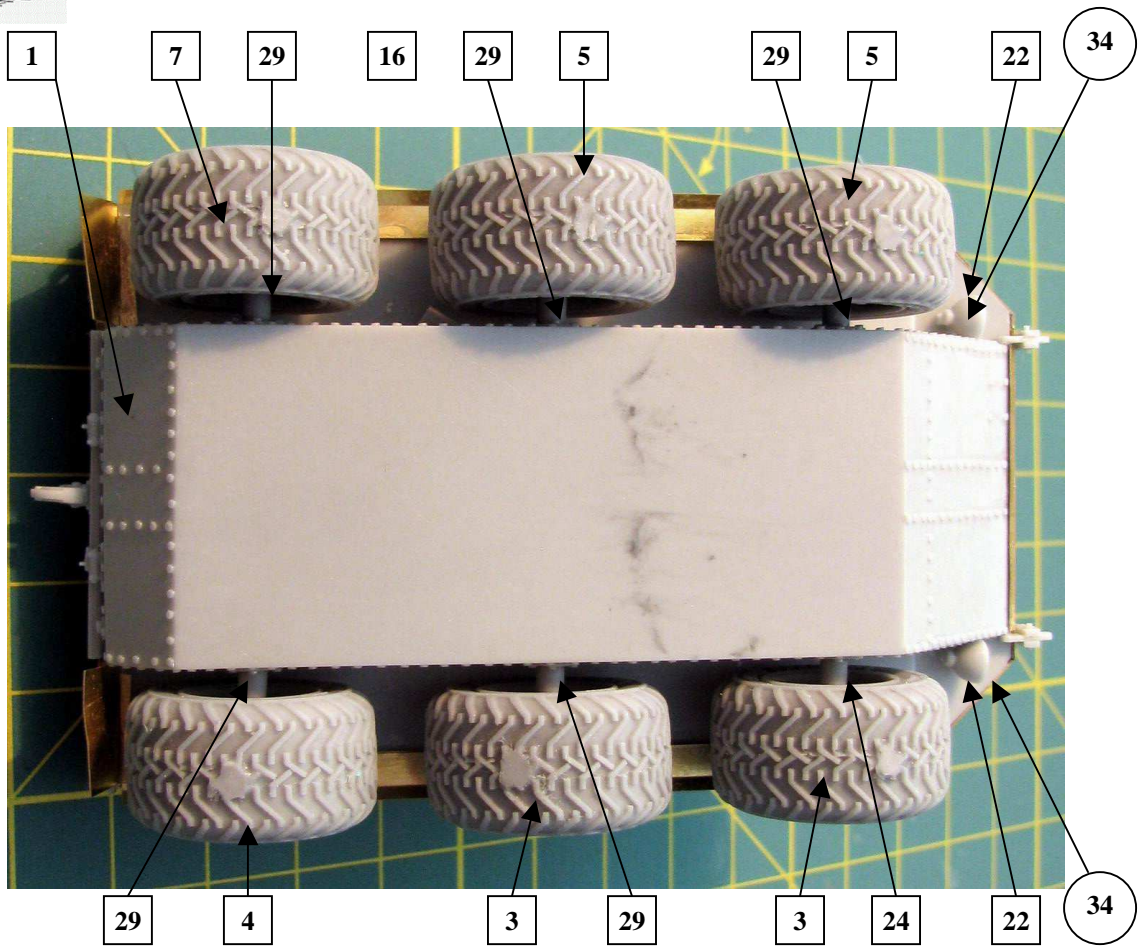



Supacat ATMP with Collapsible Fuel Drum 1/35

F3065  
6/16

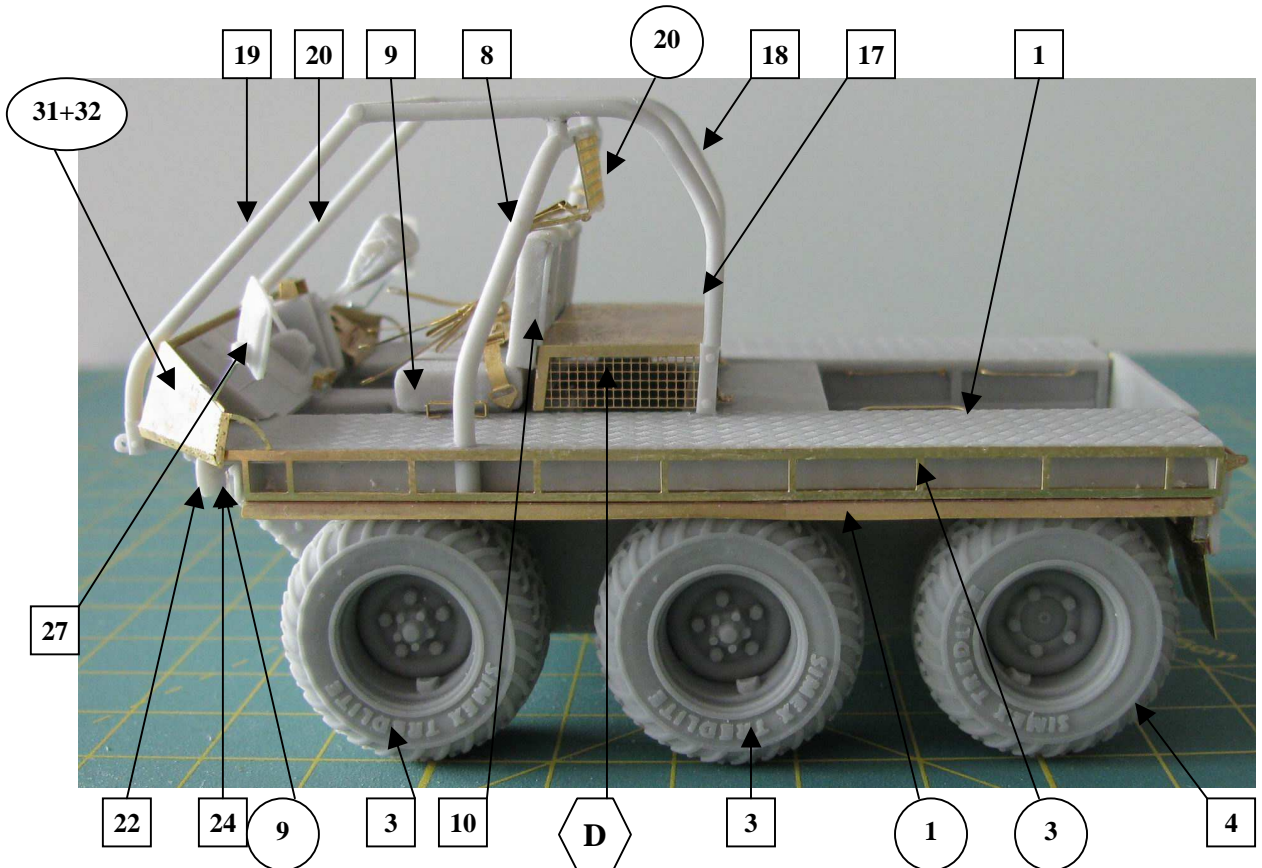
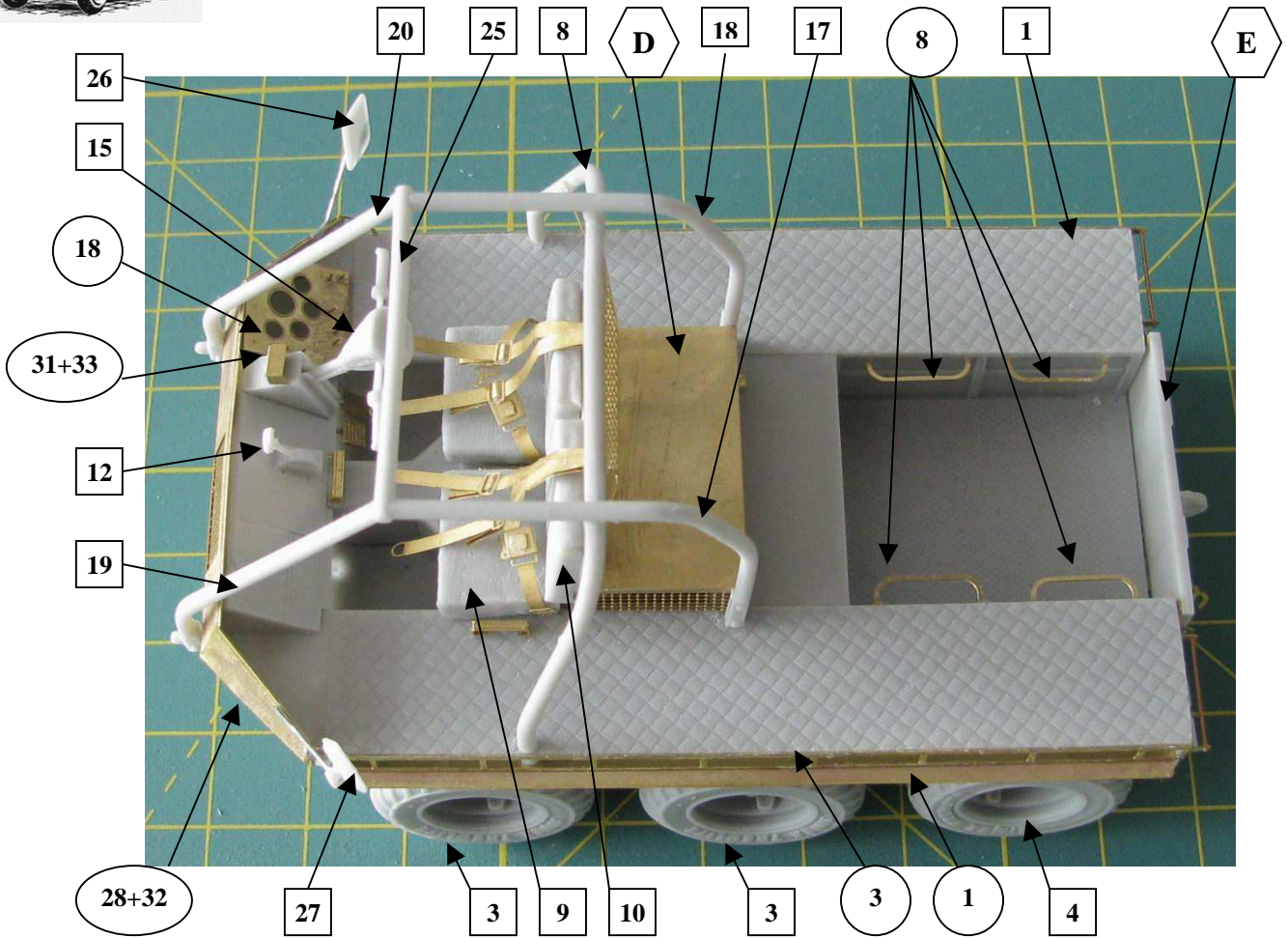

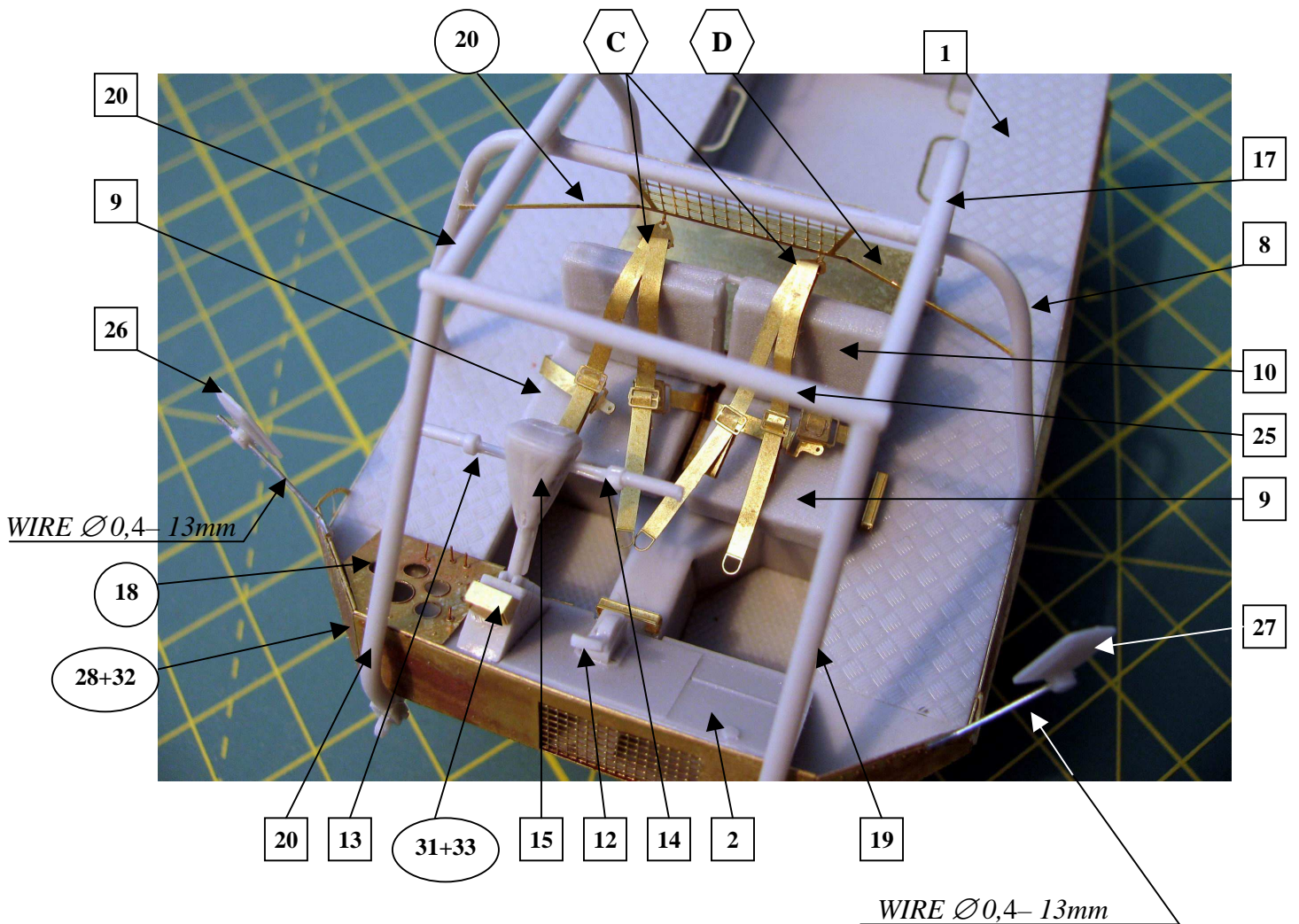
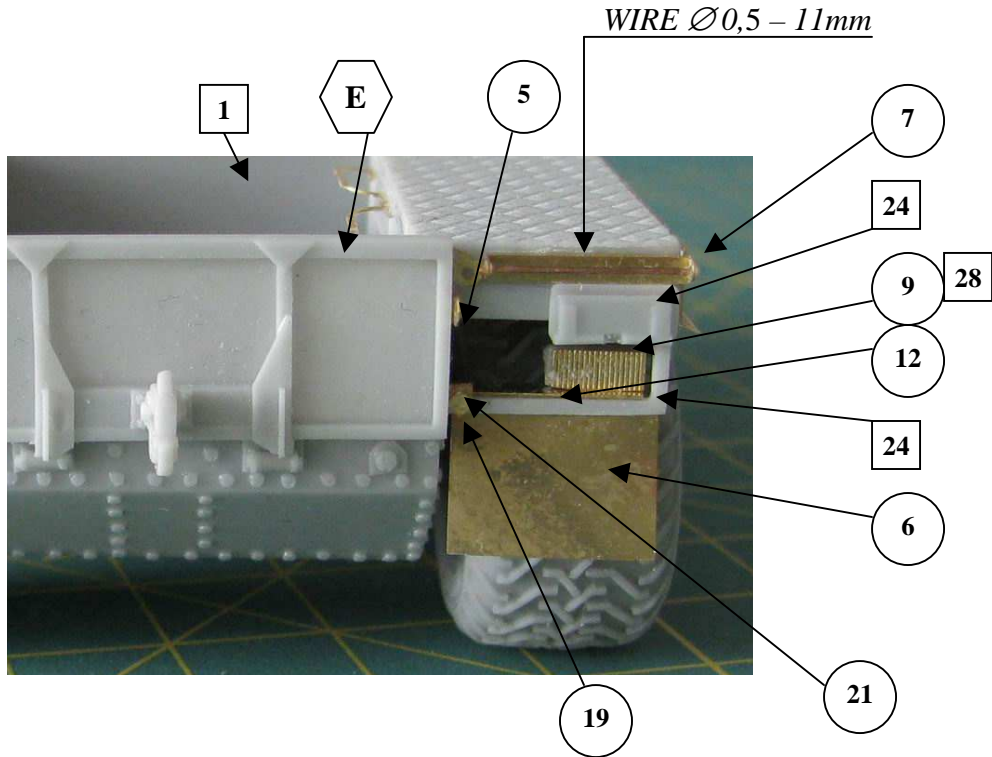



F

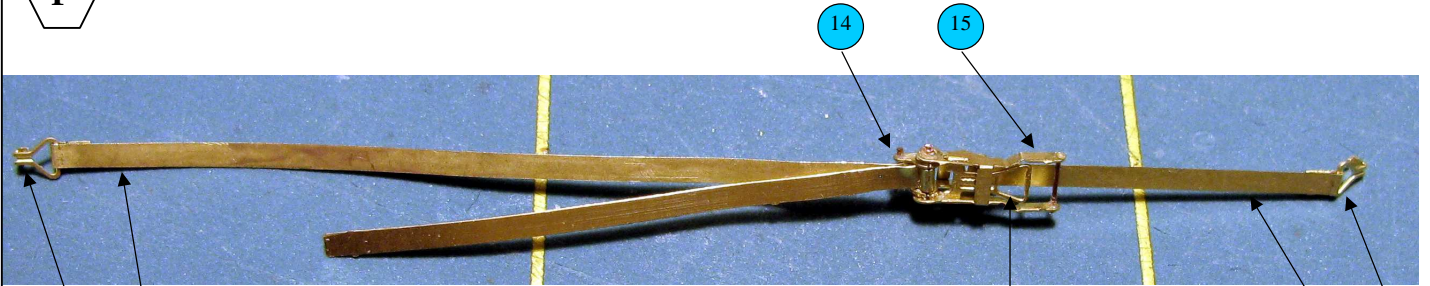

6 12

14 15

12 6

12 WIRE  $\varnothing$ .2-2.0mm 14 WIRE  $\varnothing$ .3-2.5mm 11 11 15 12 WIRE  $\varnothing$ .2-3.0mm

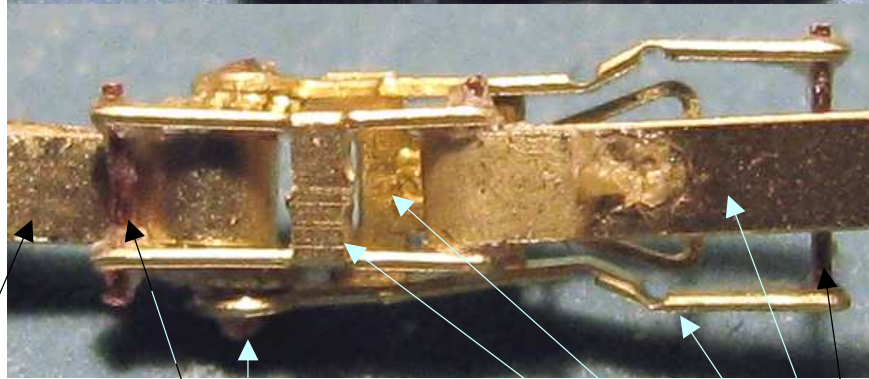
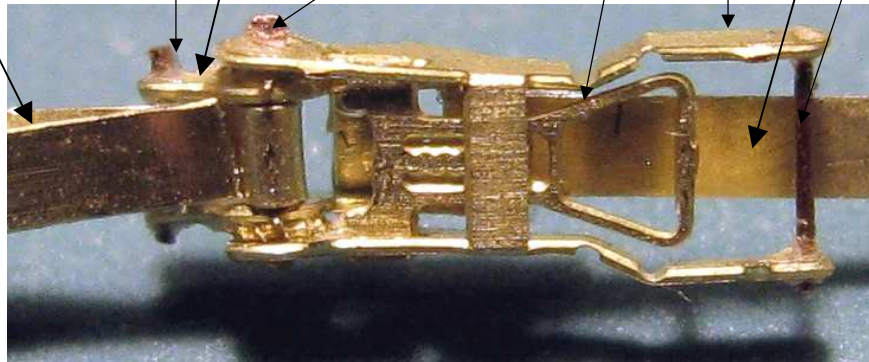

12 WIRE  $\varnothing$ .2-2.0mm WIRE  $\varnothing$ .3-2.5mm 14 11 15 12 WIRE  $\varnothing$ .2-3.0mm







G

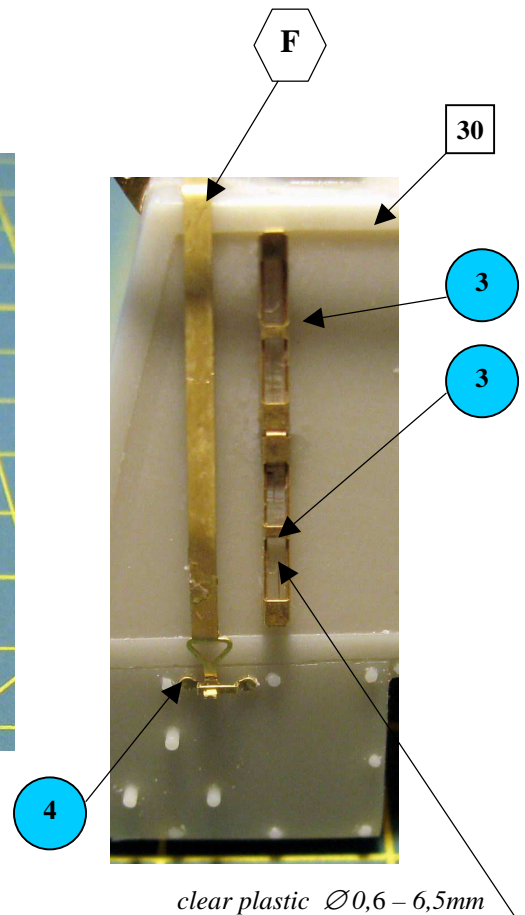
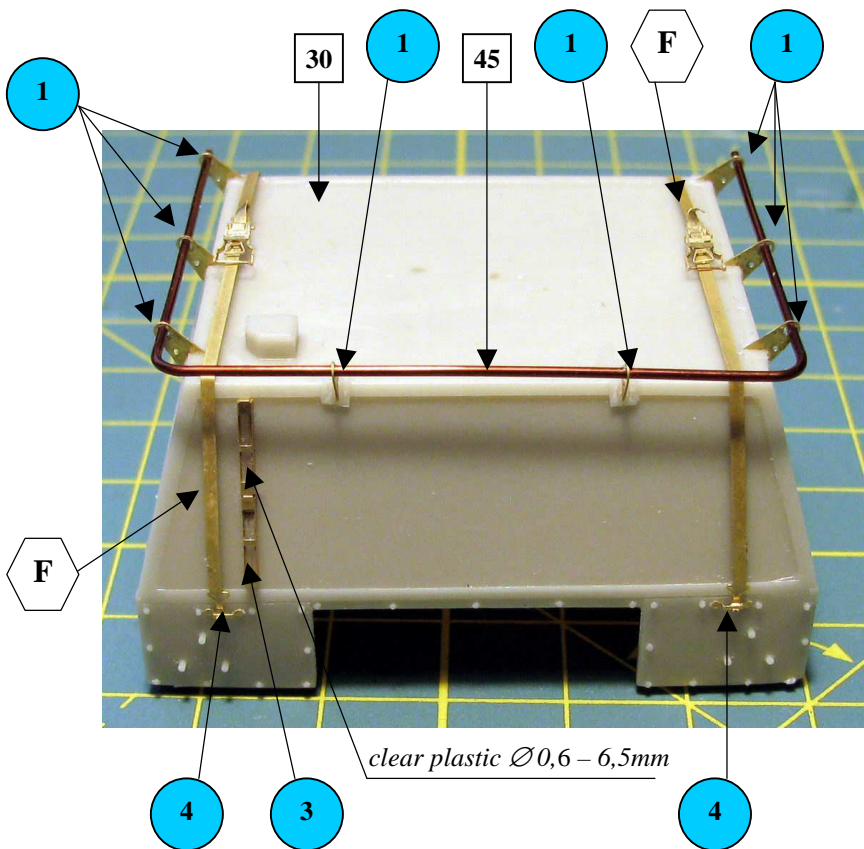
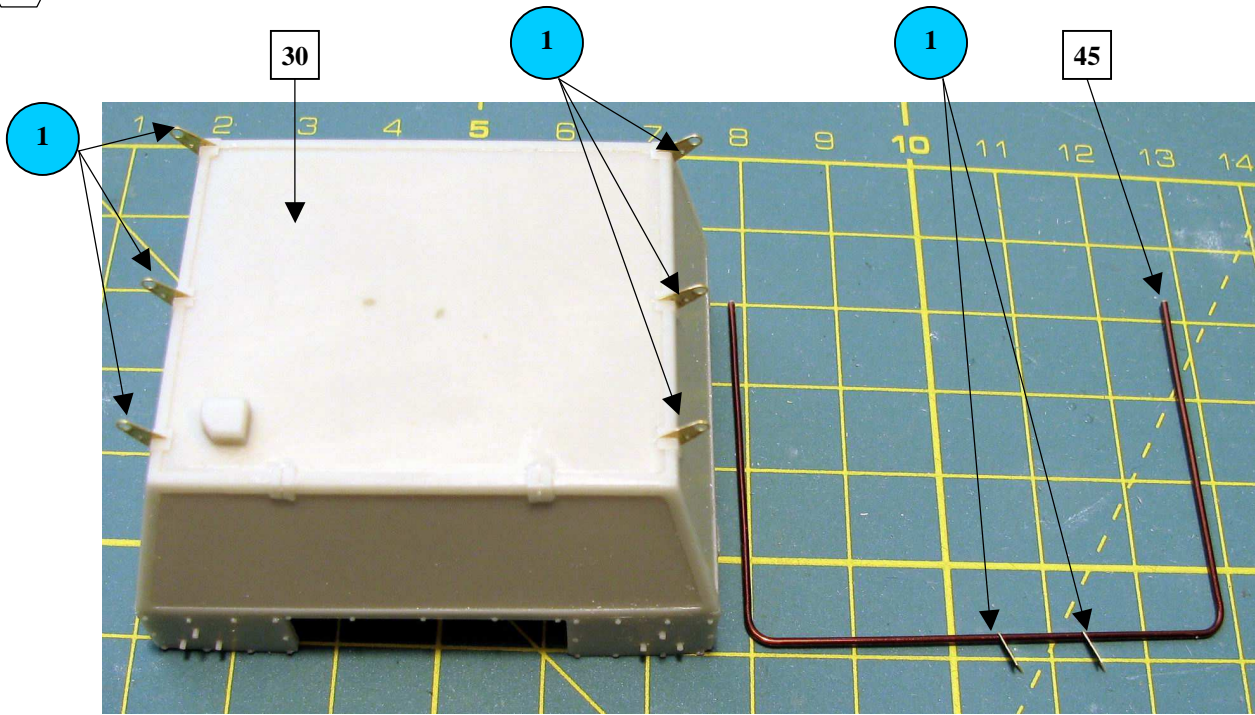



G

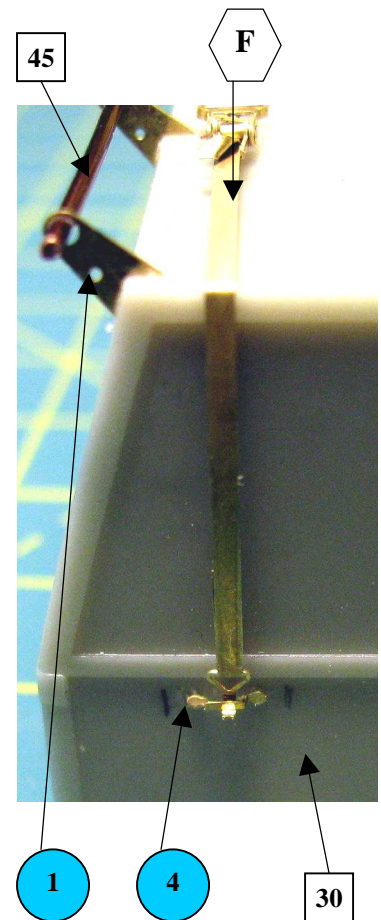
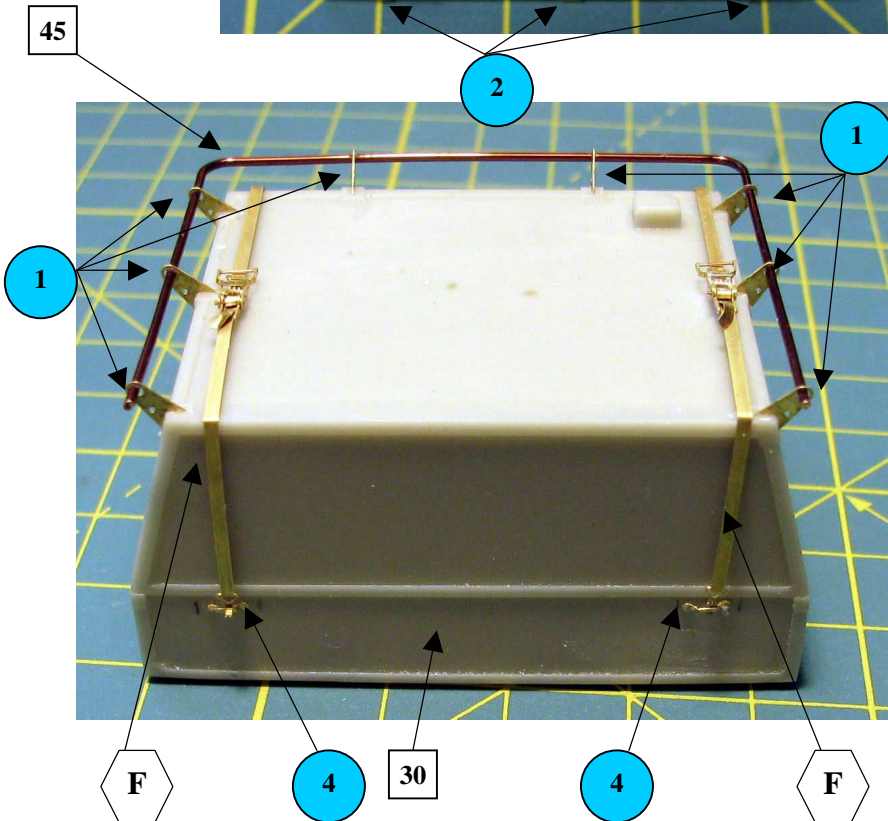
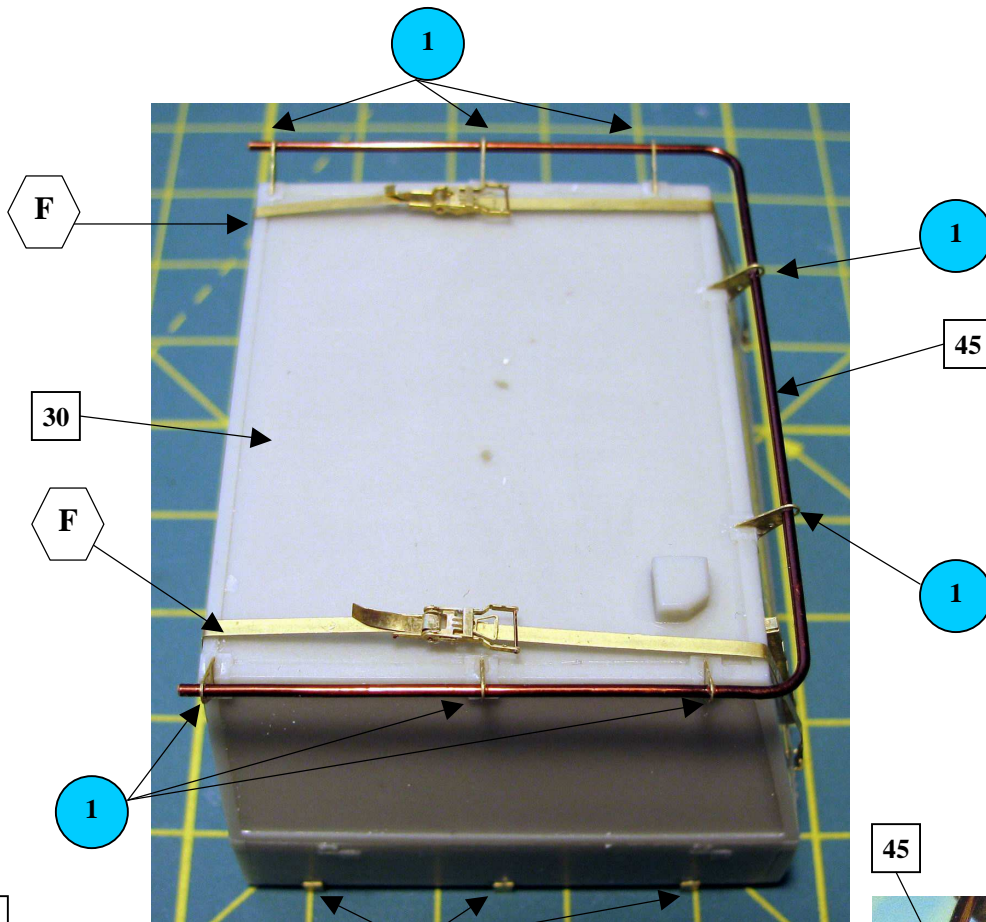



H

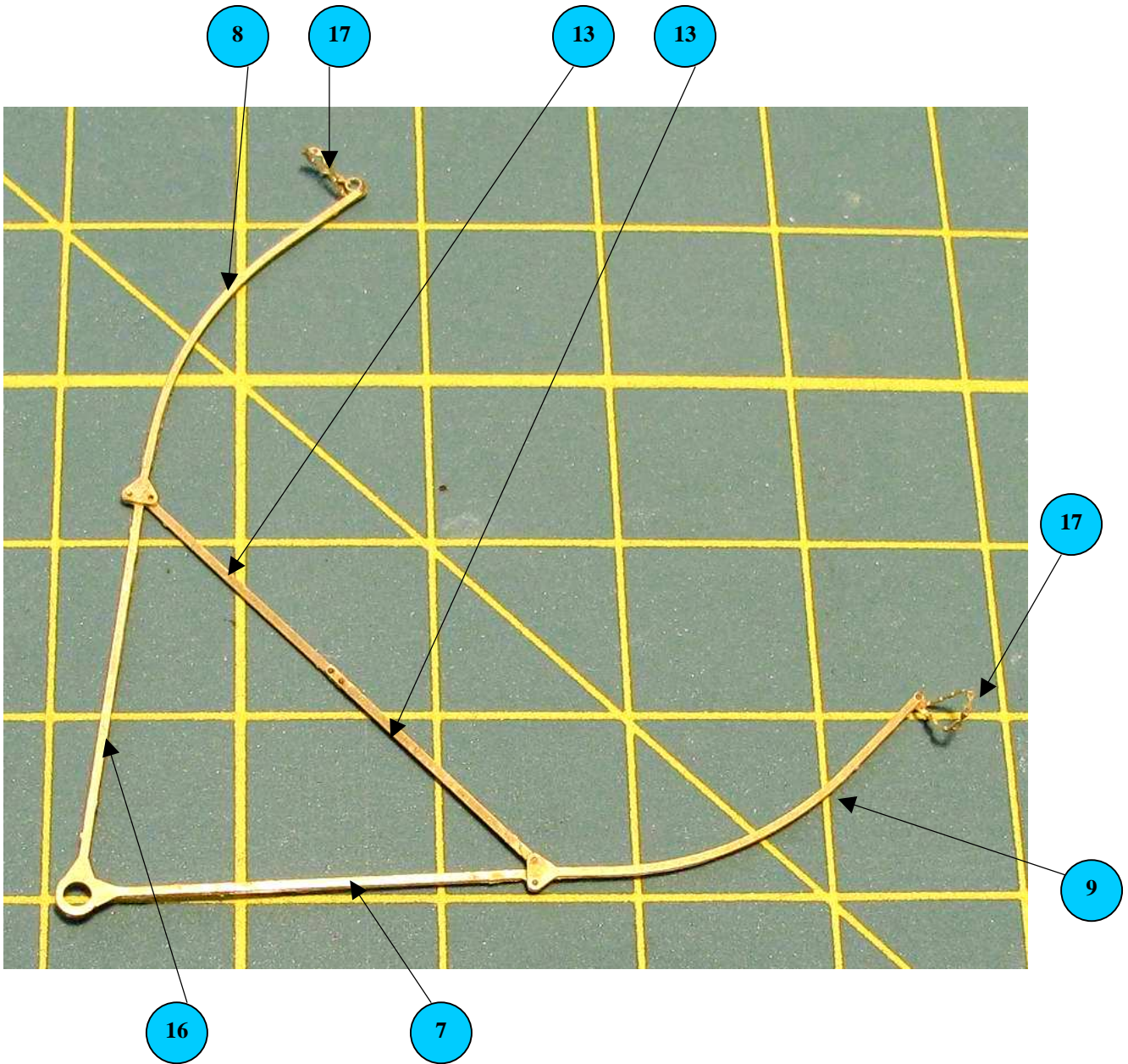



I

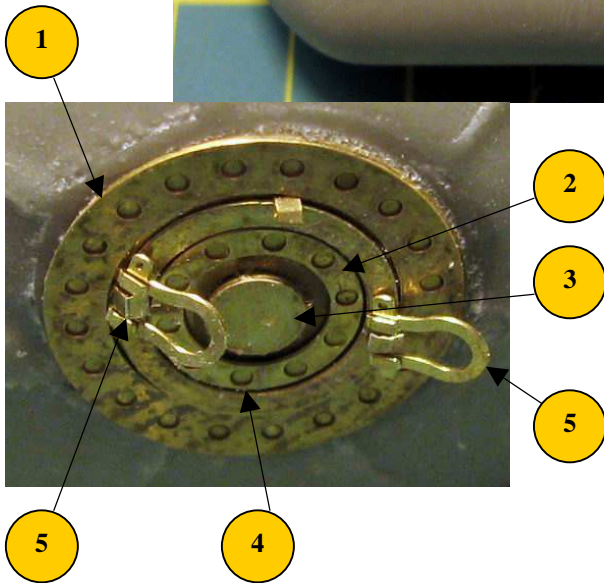
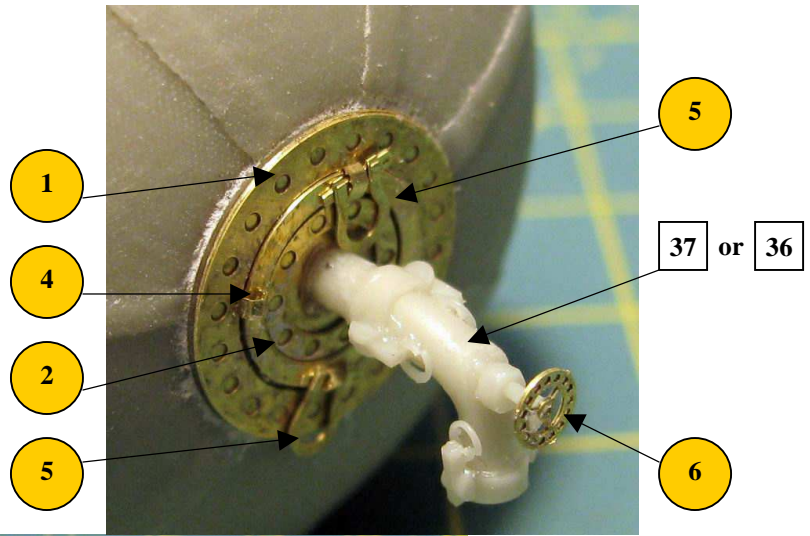



J

