

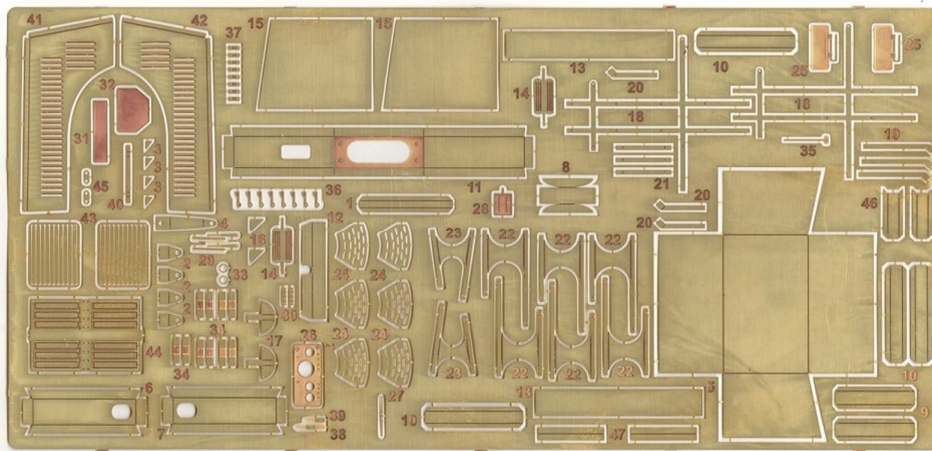

MMK Folknáře 70 40501 Děčín www.mmk.cz mk.model@volny.cz

35054

TATRA T 141



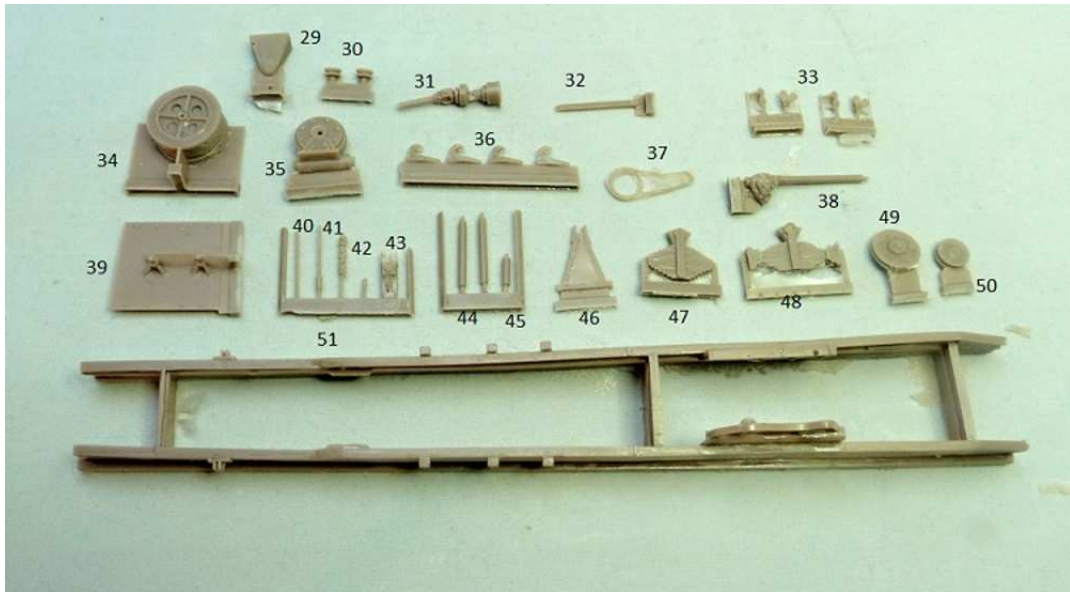
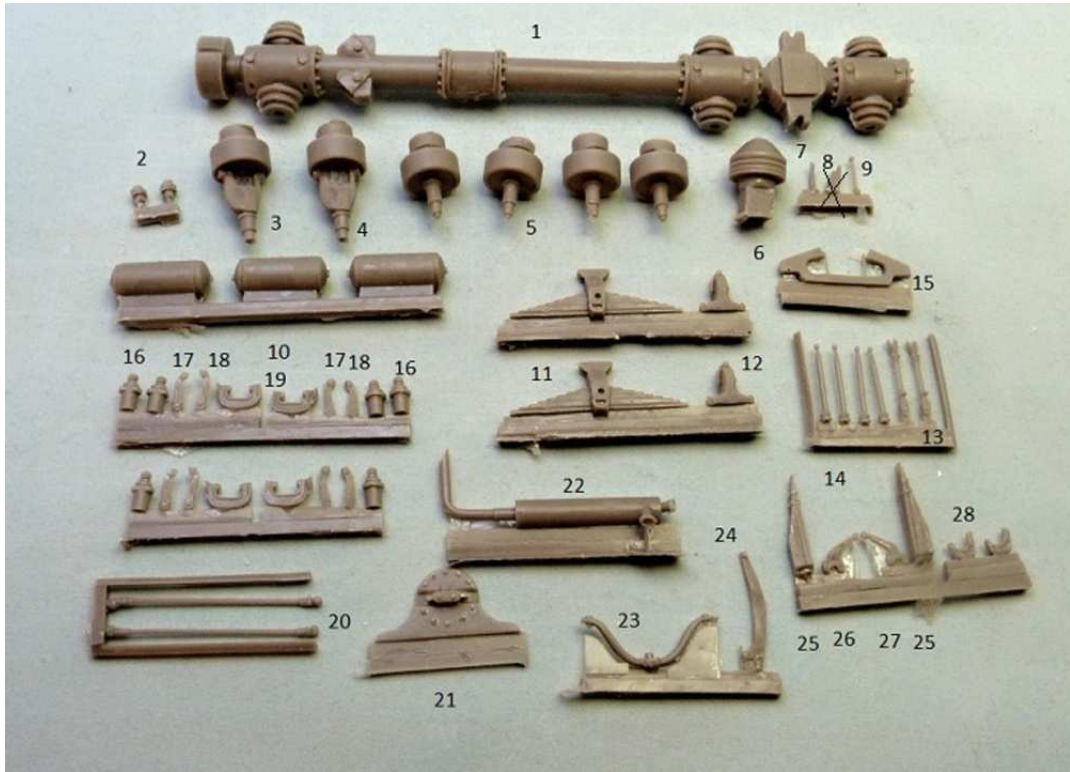

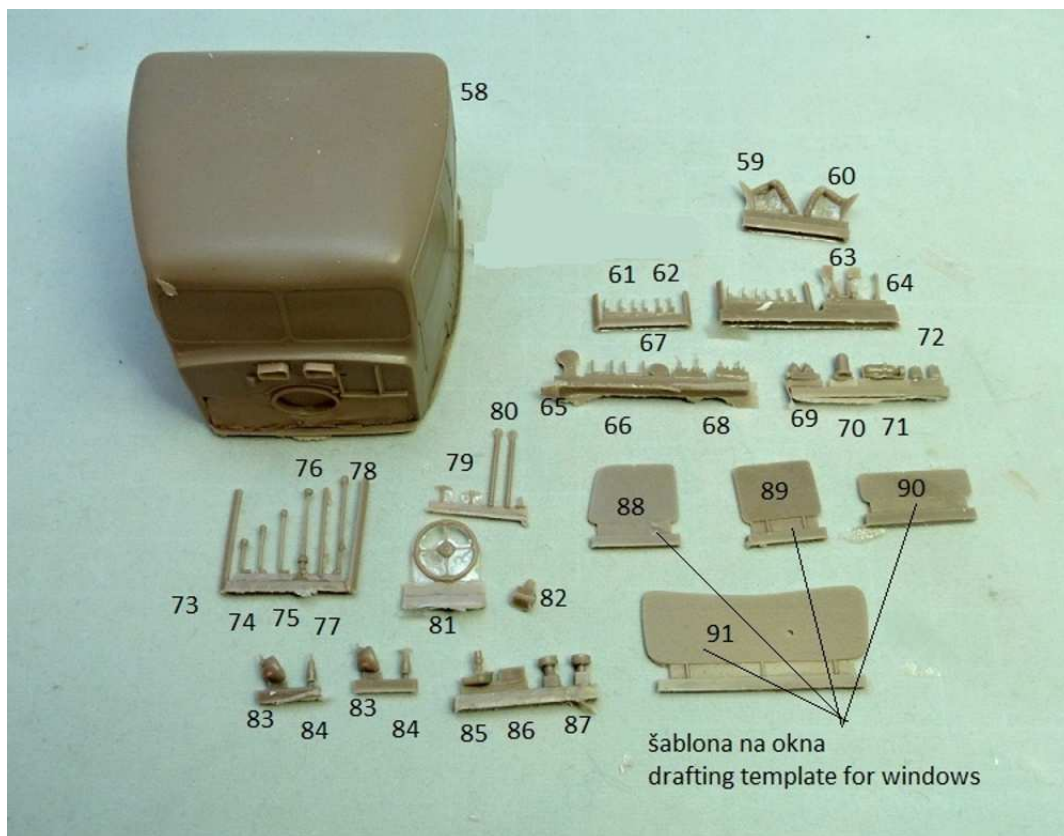
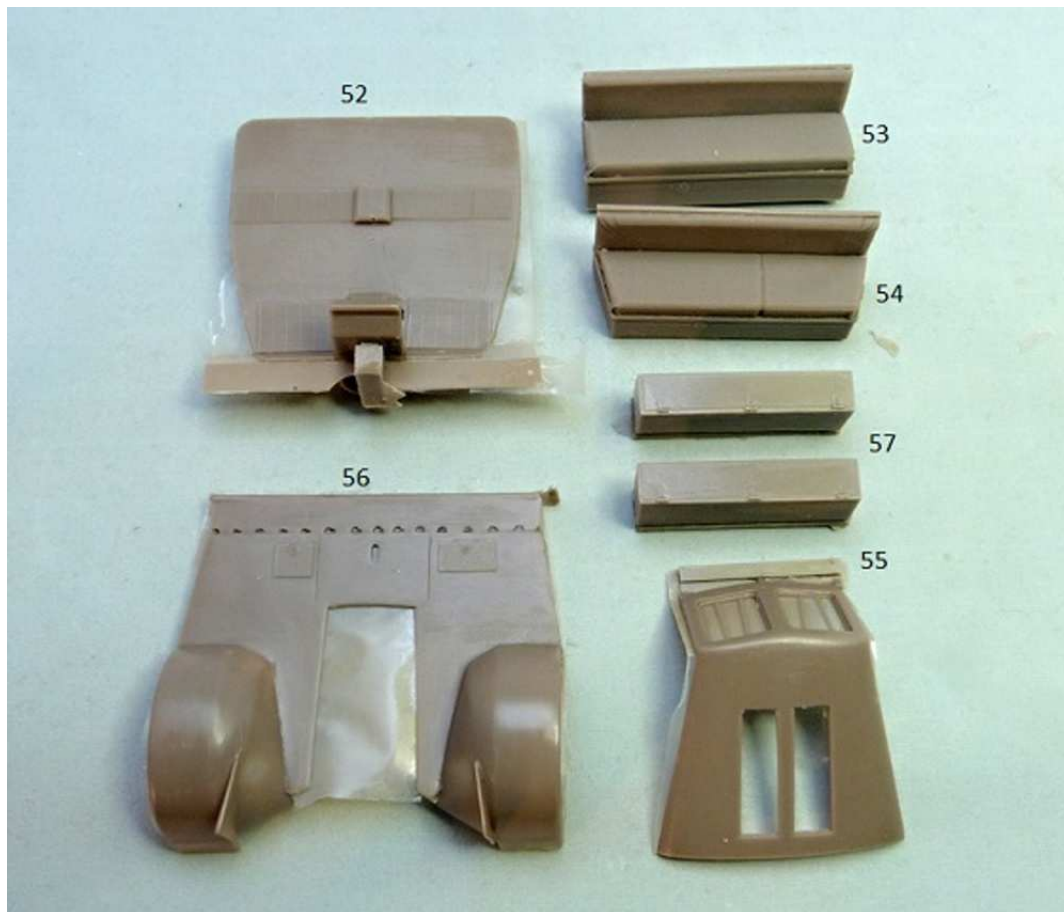

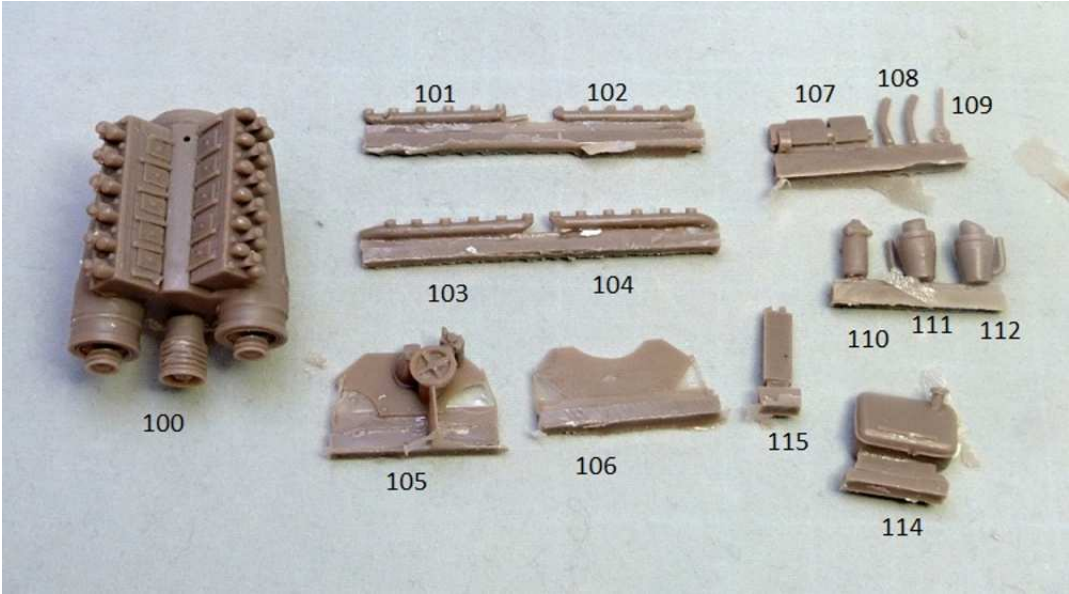
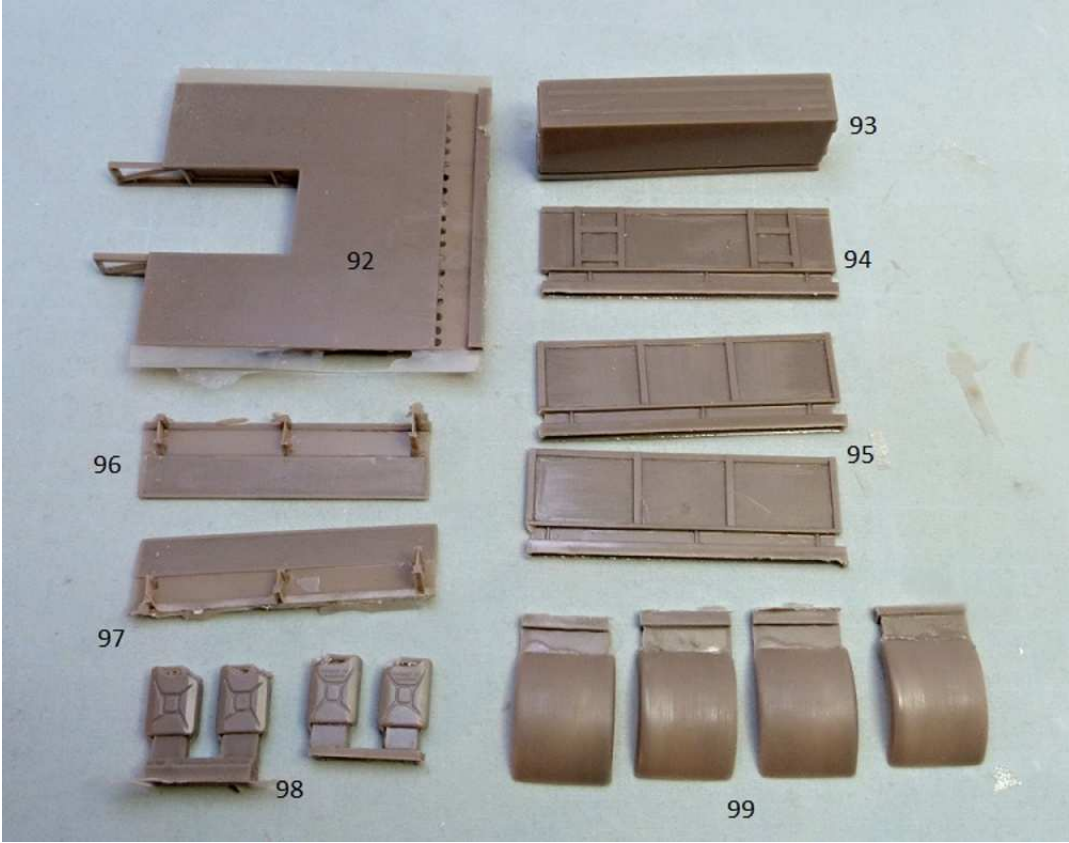

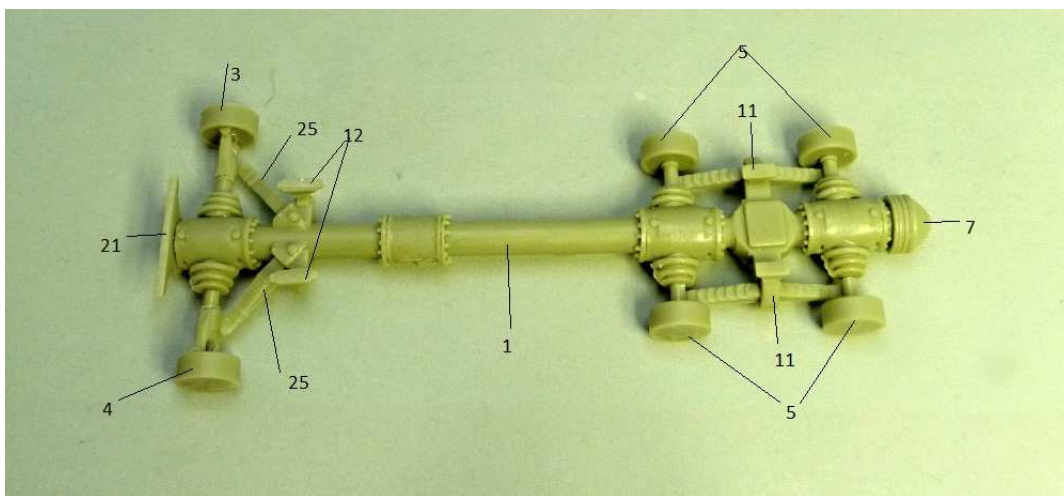
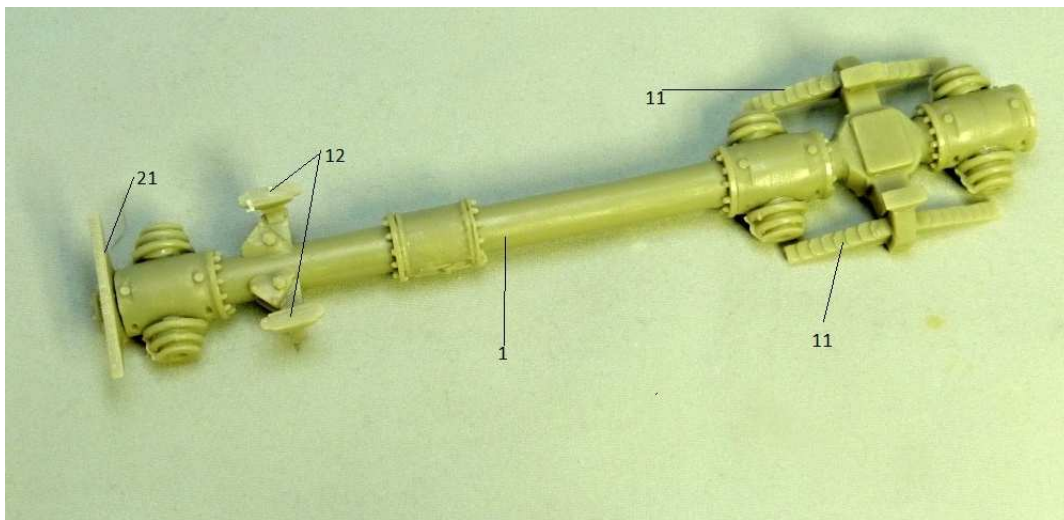
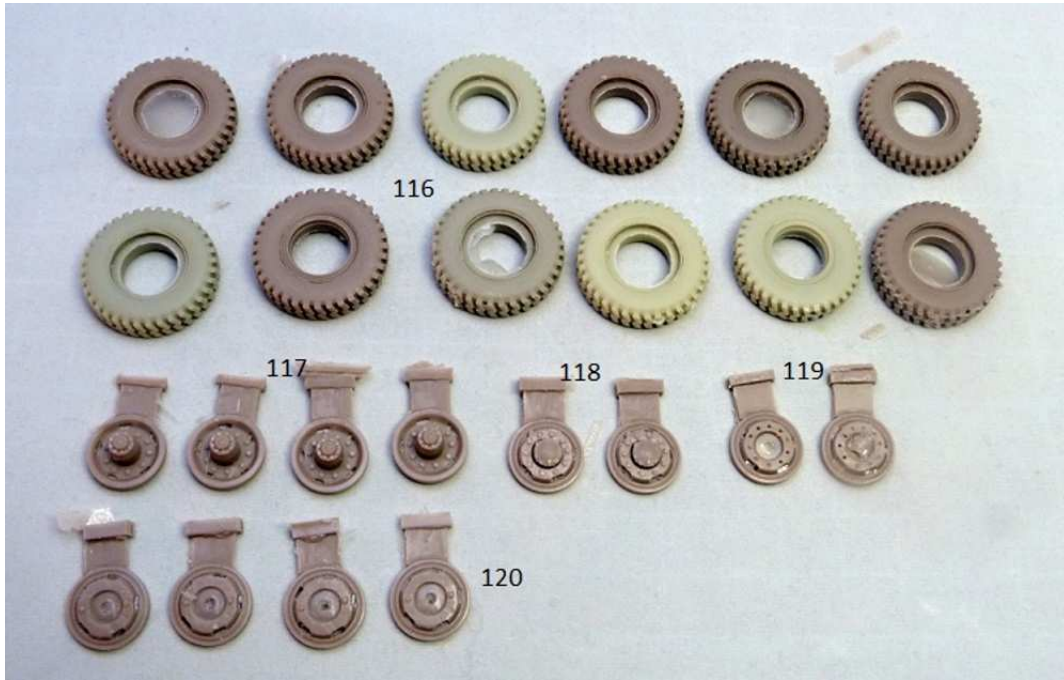

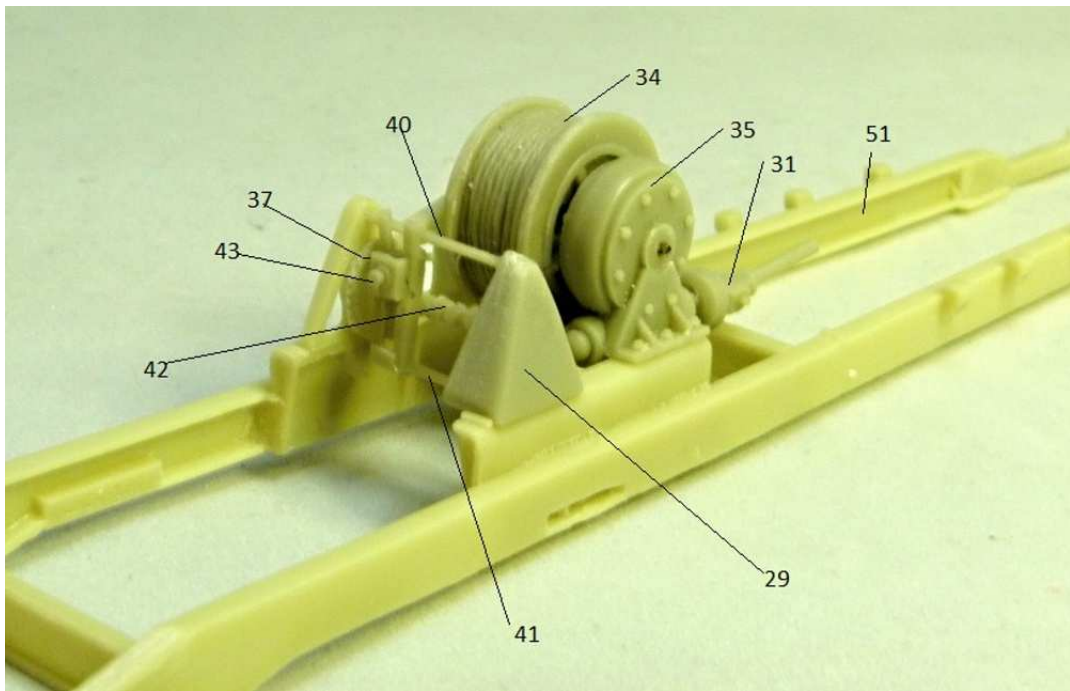
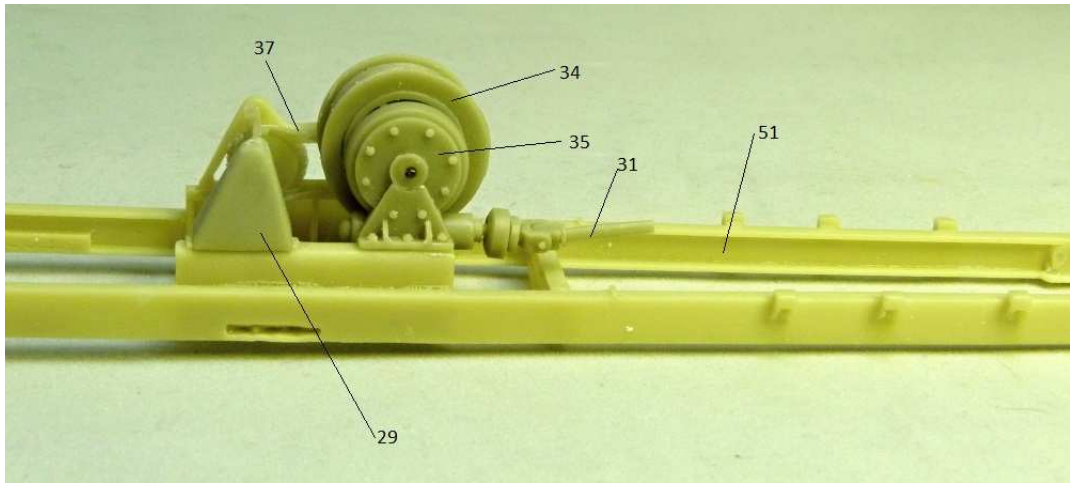
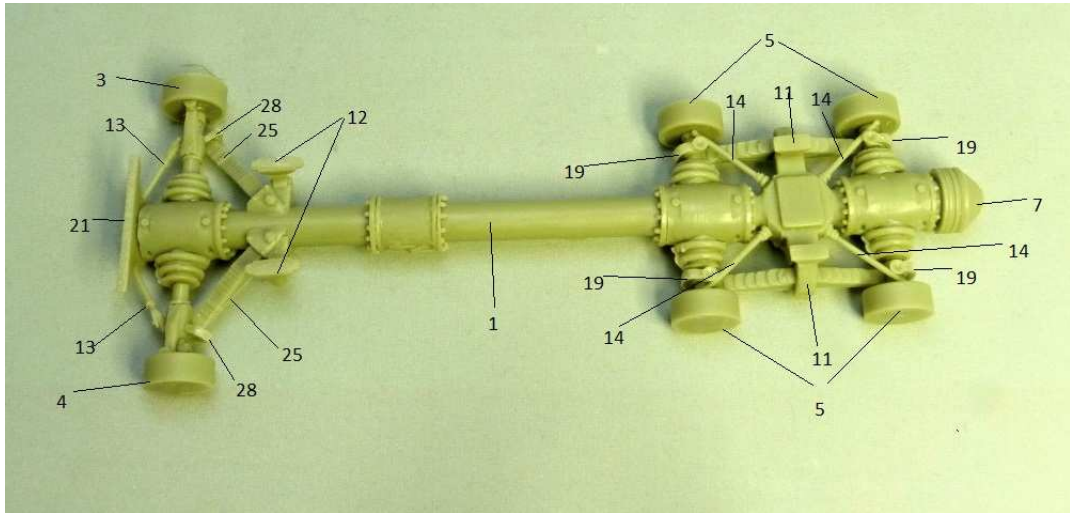

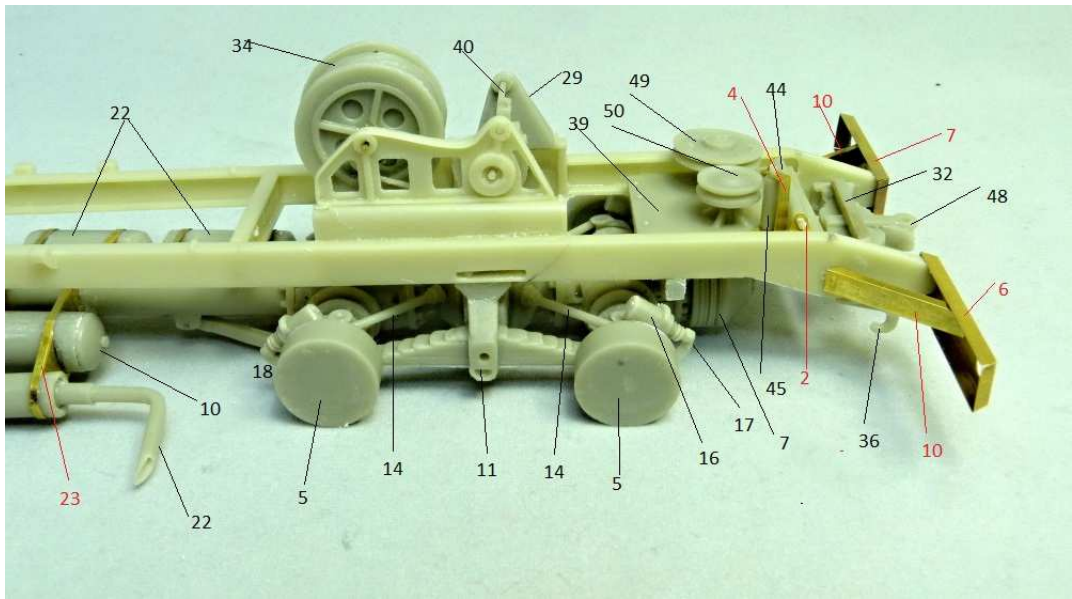
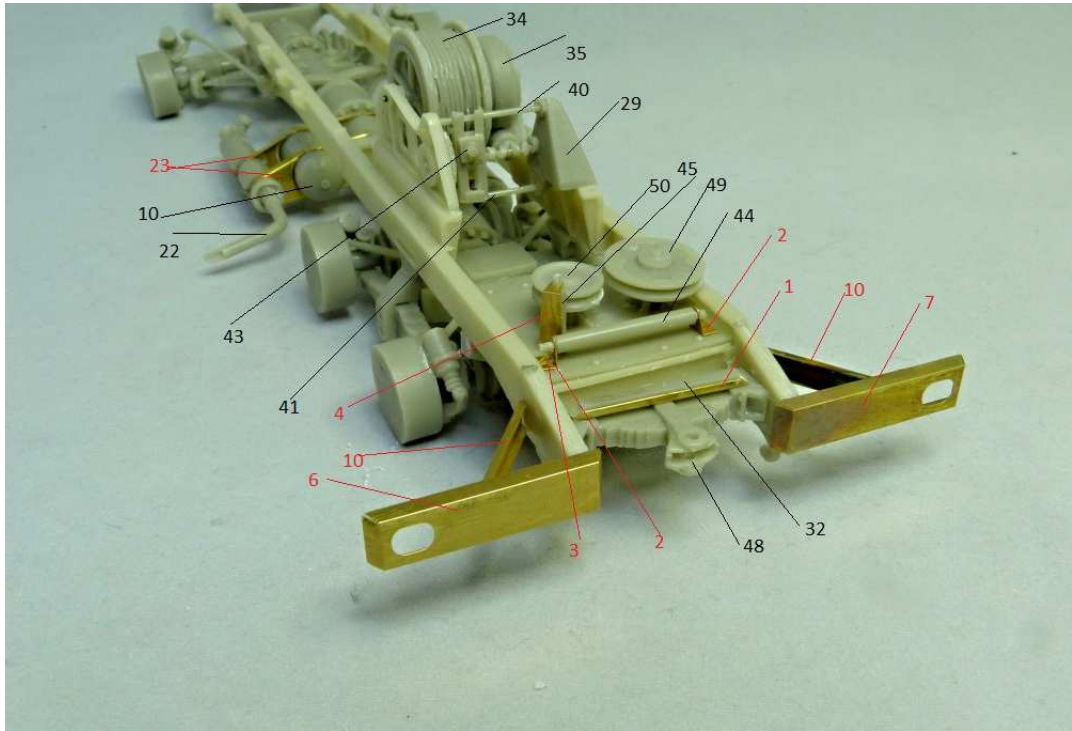

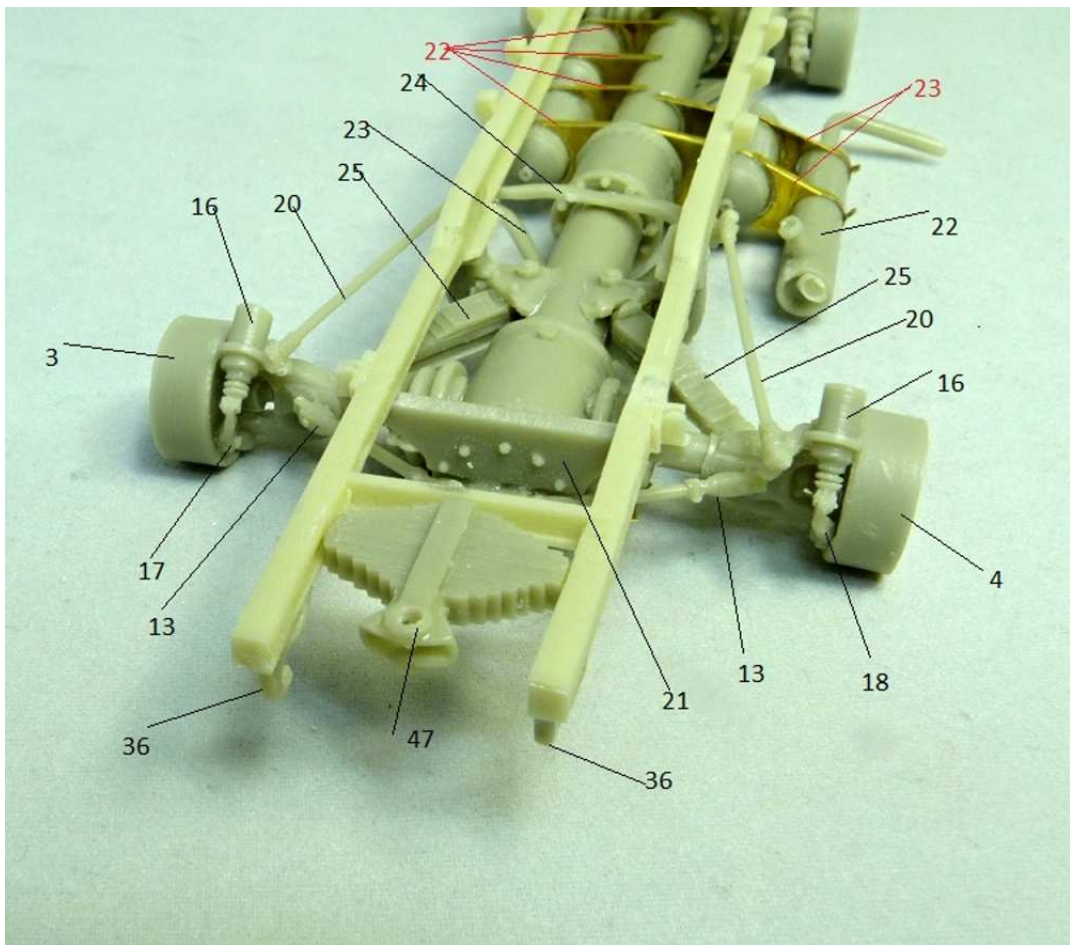
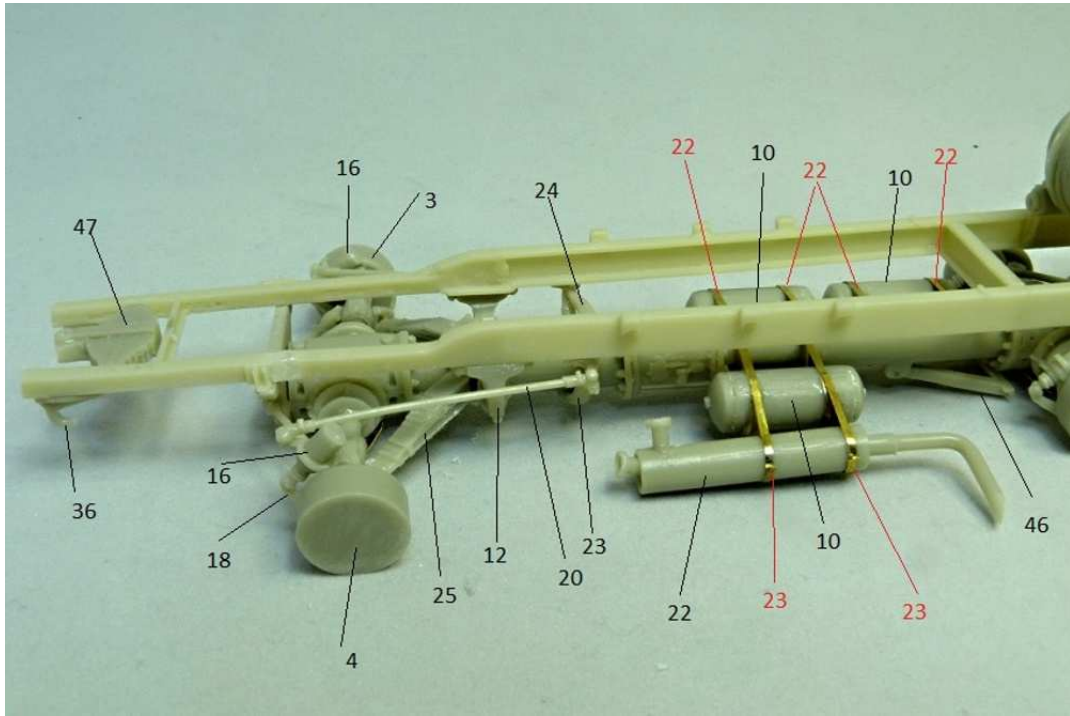

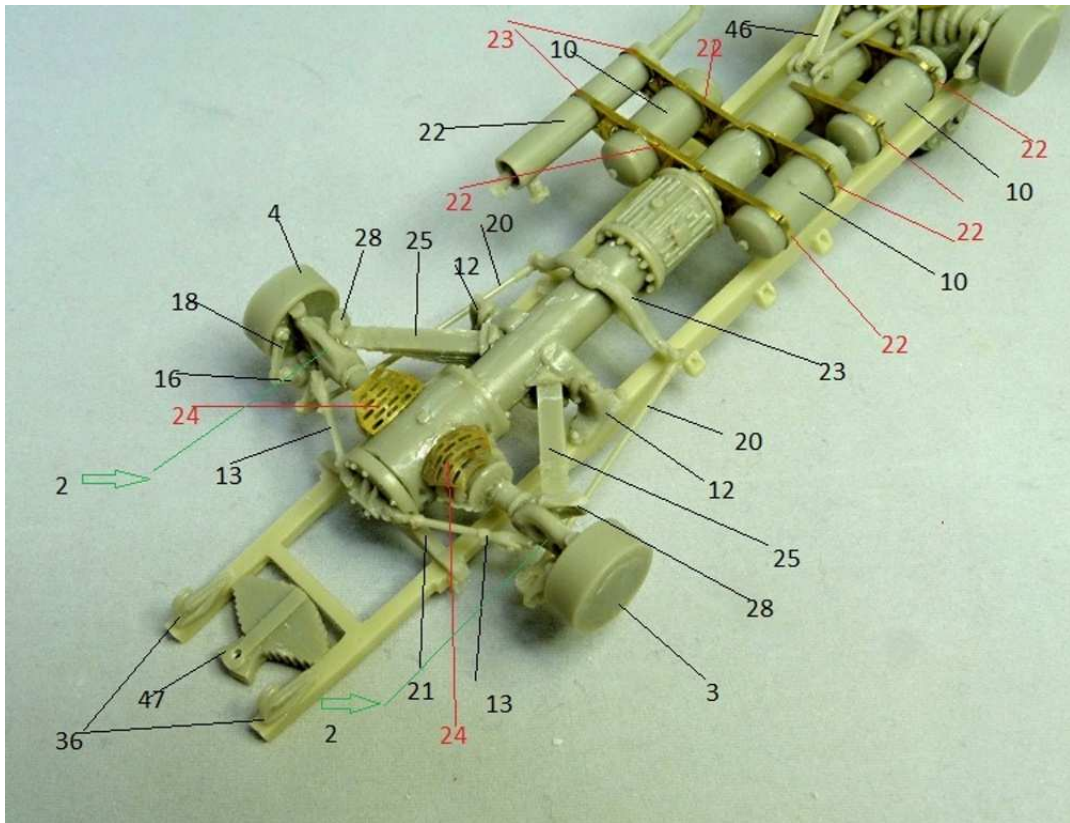
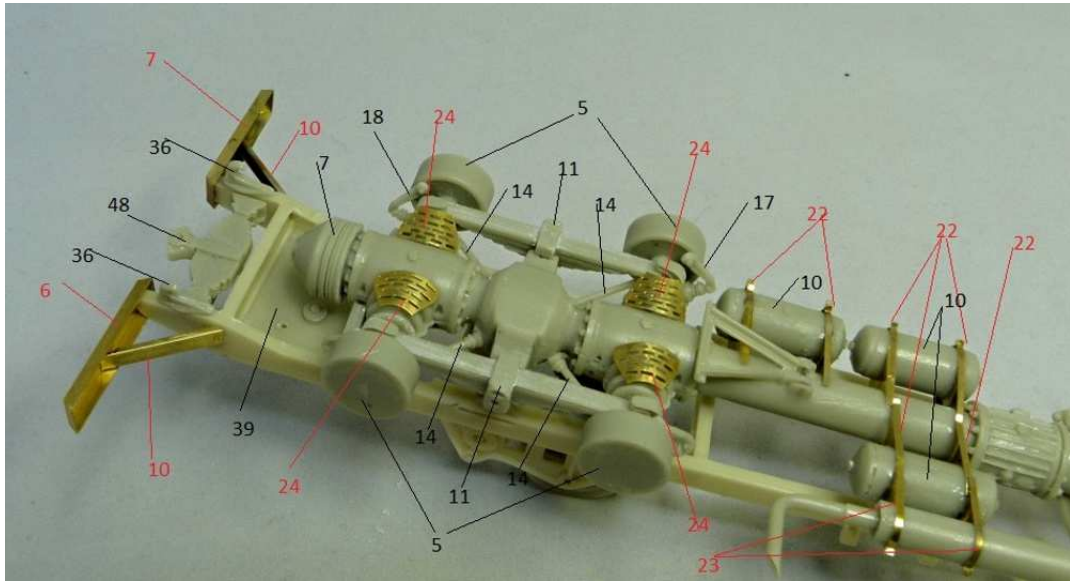

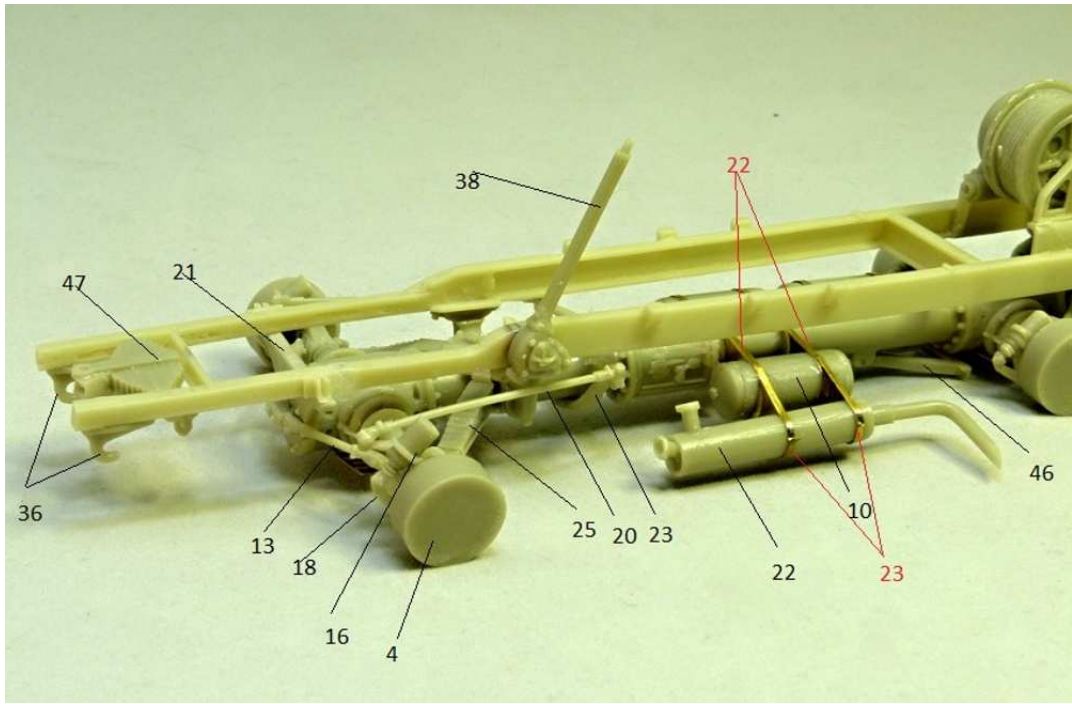
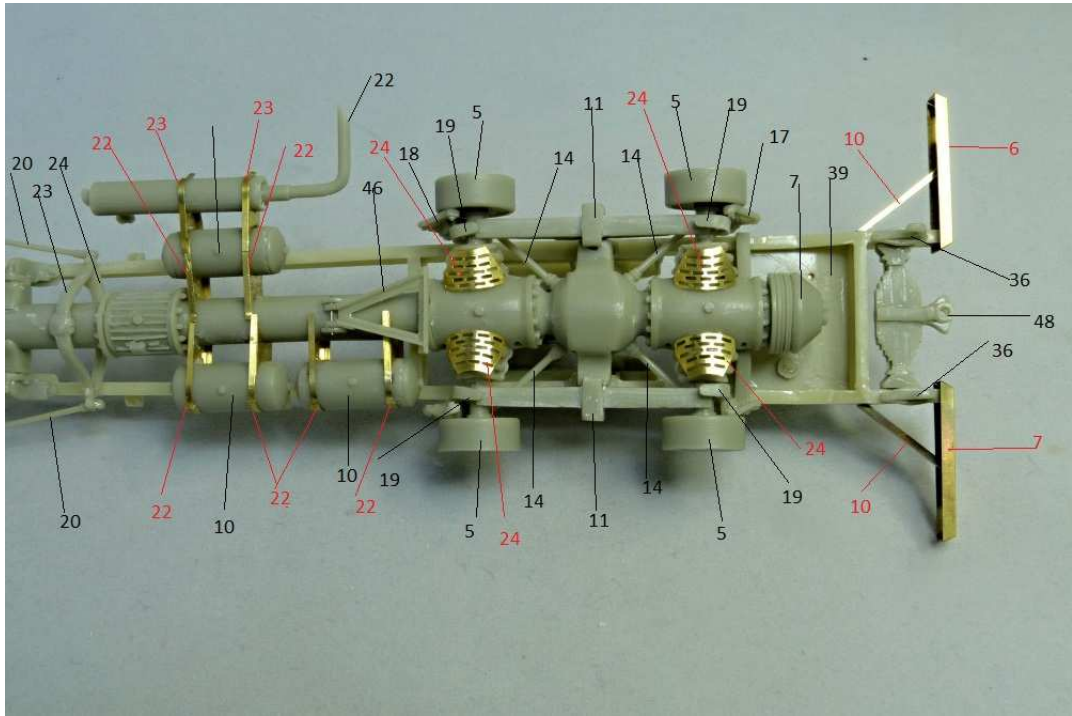

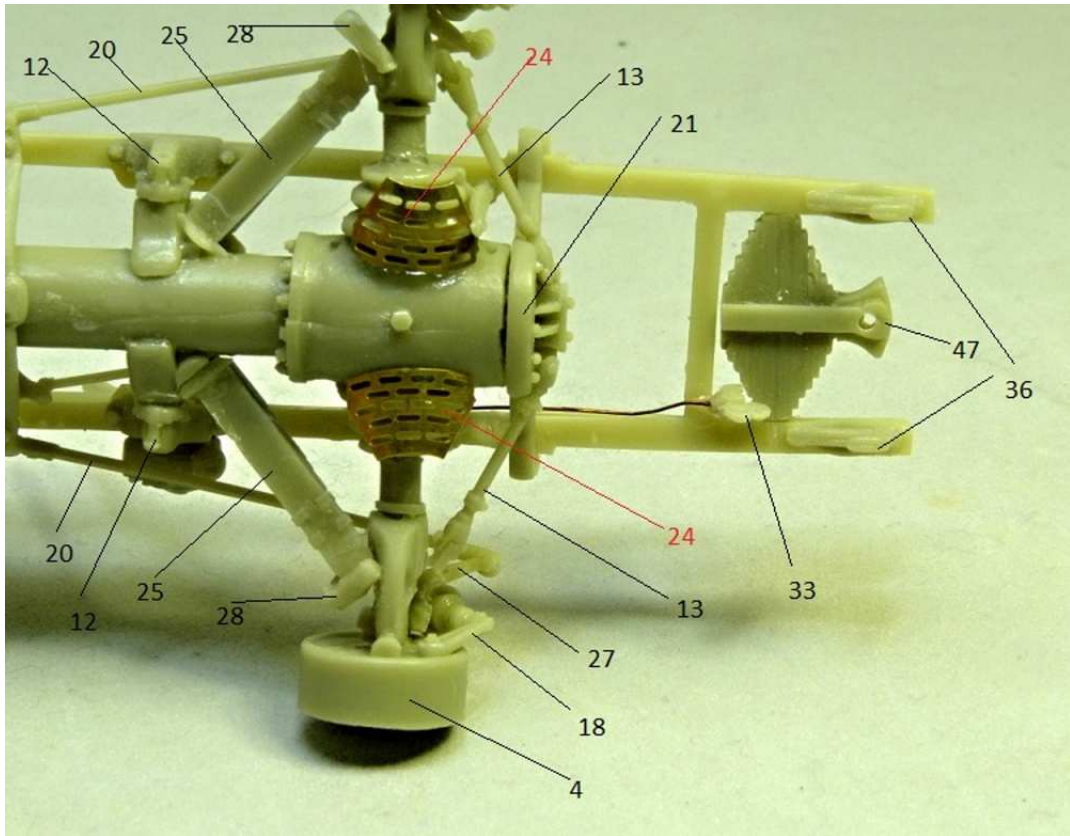
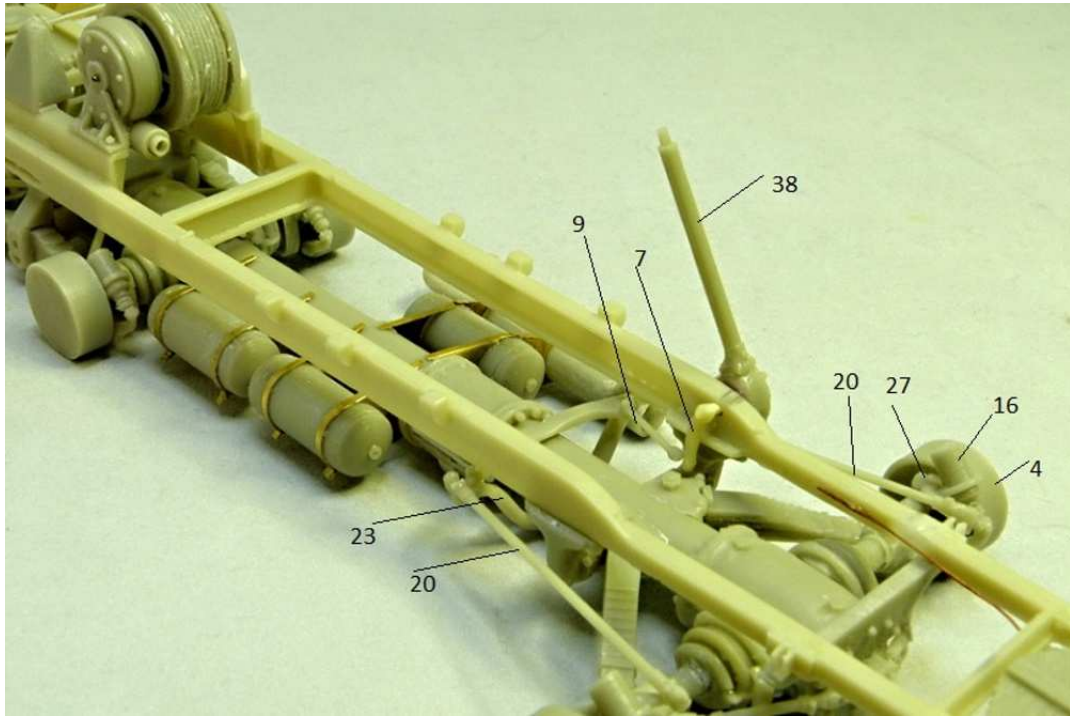

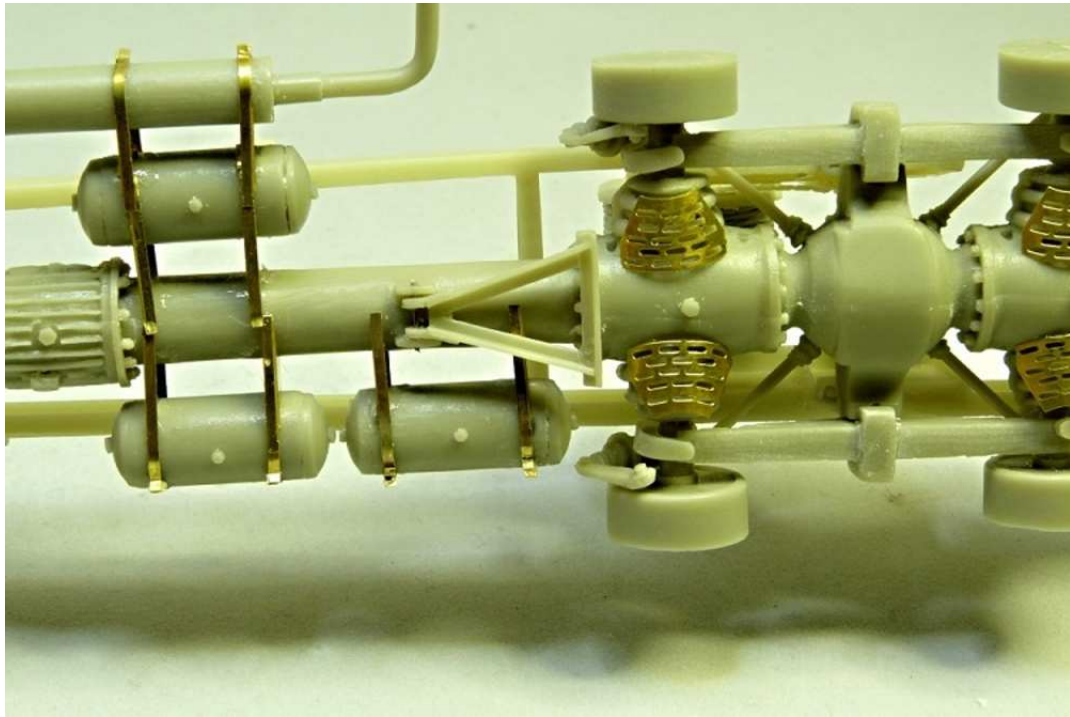
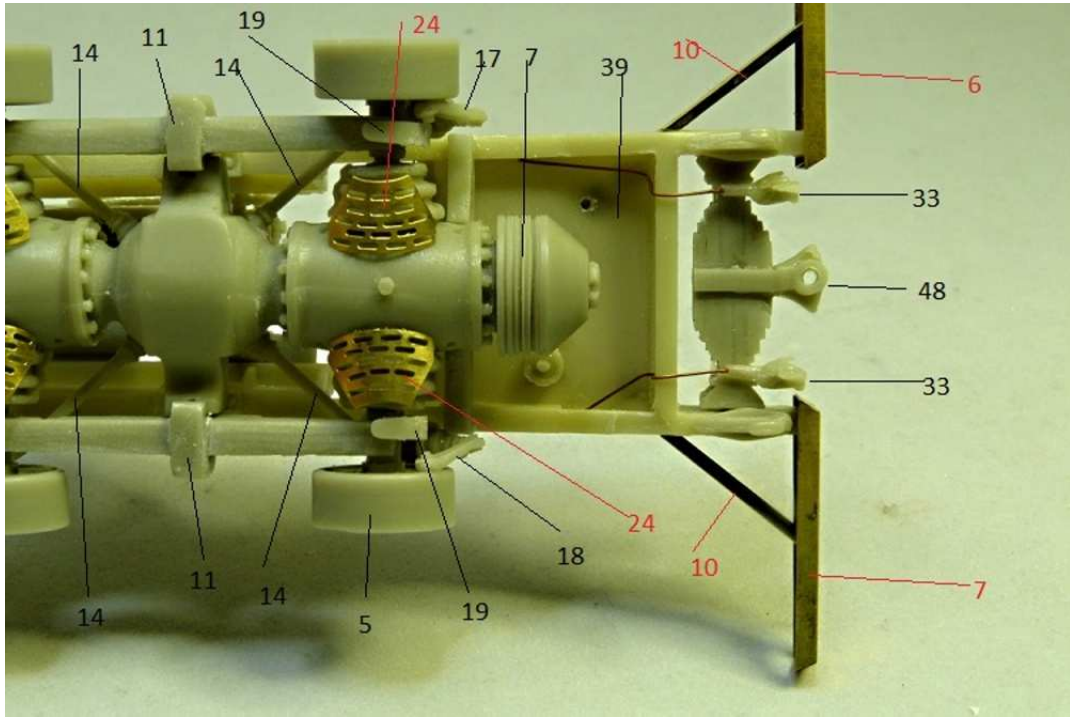

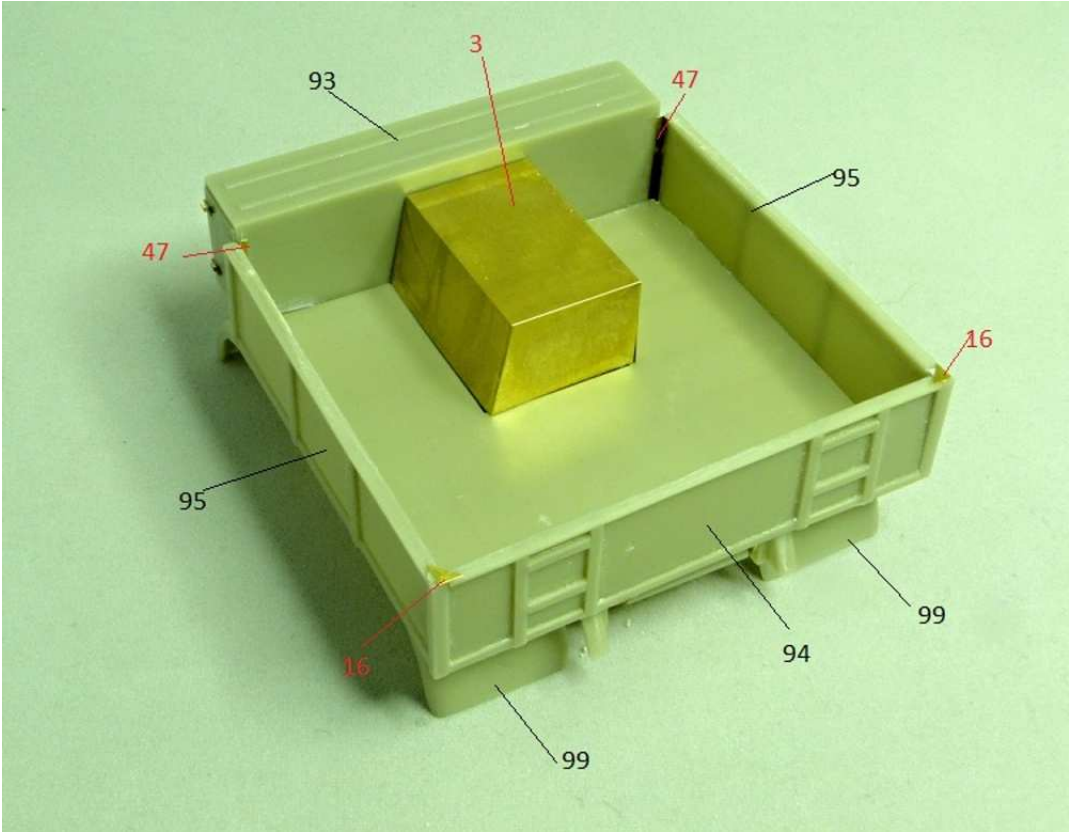
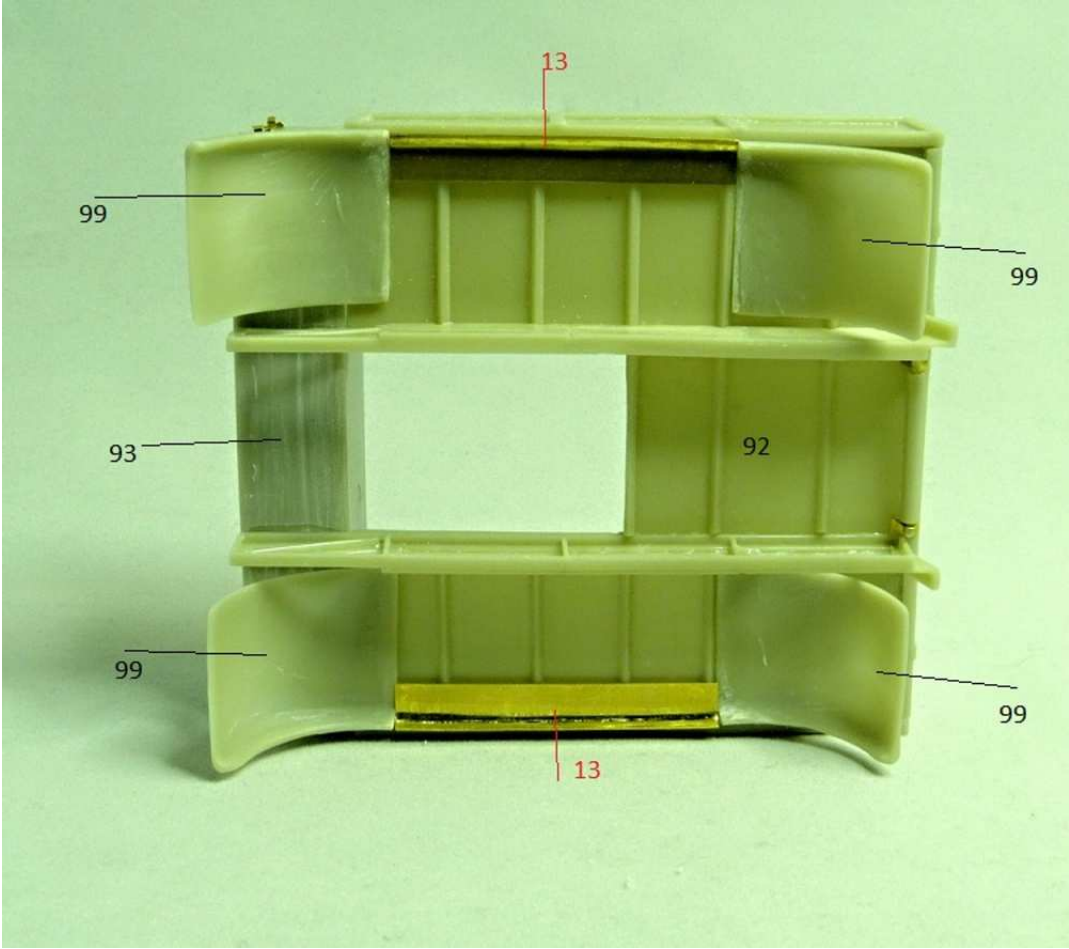

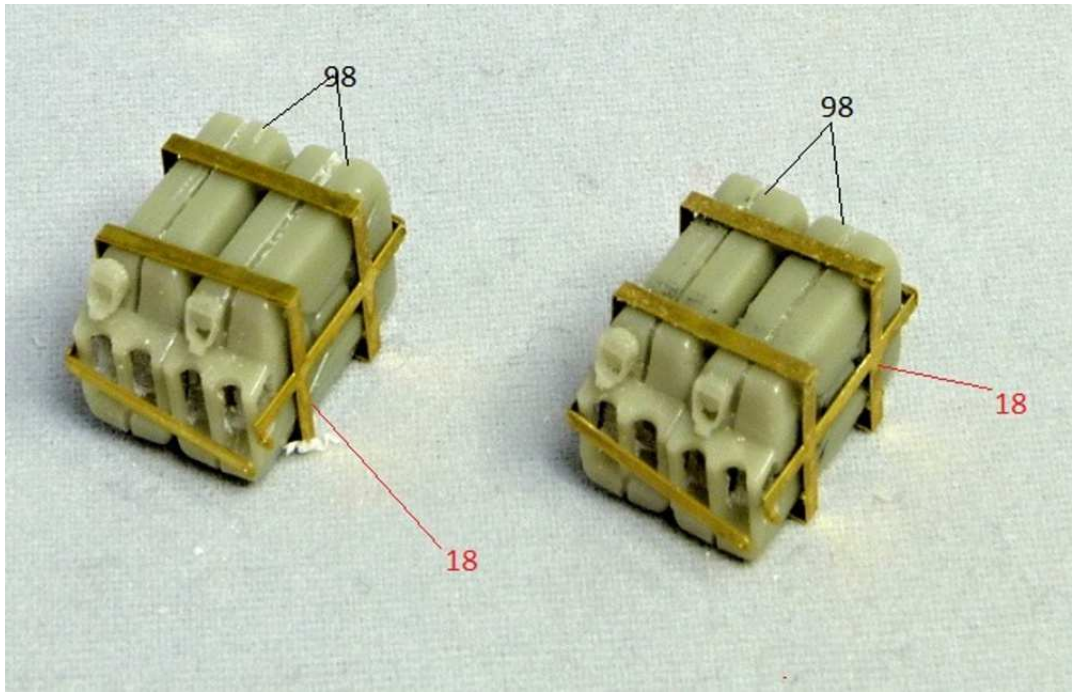
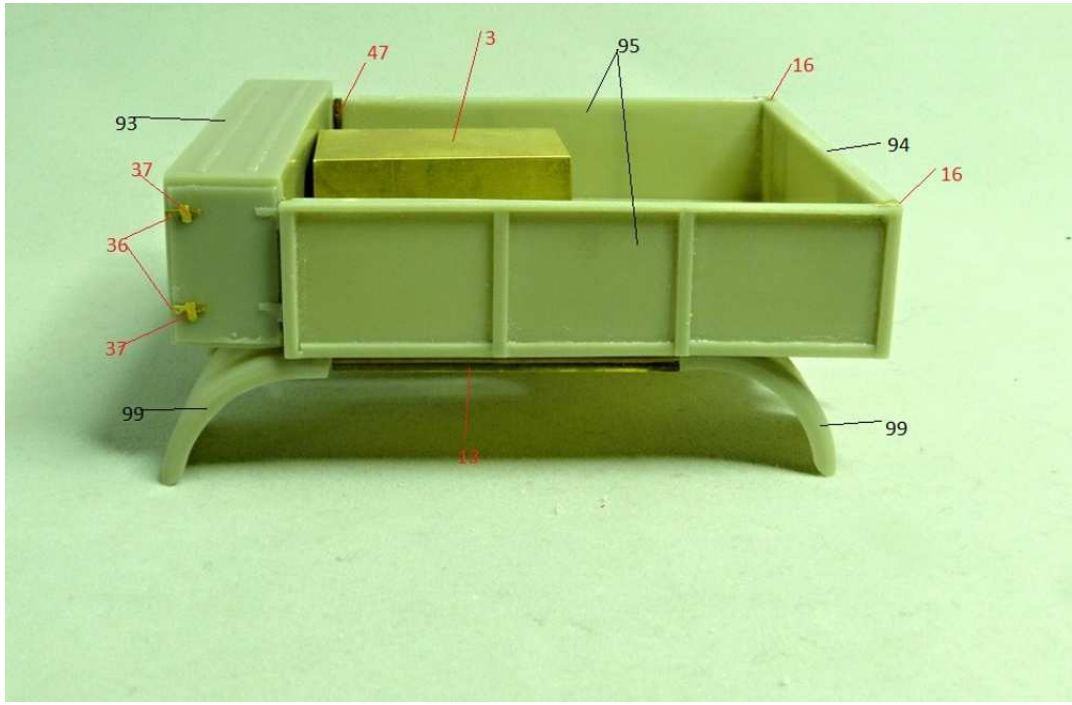

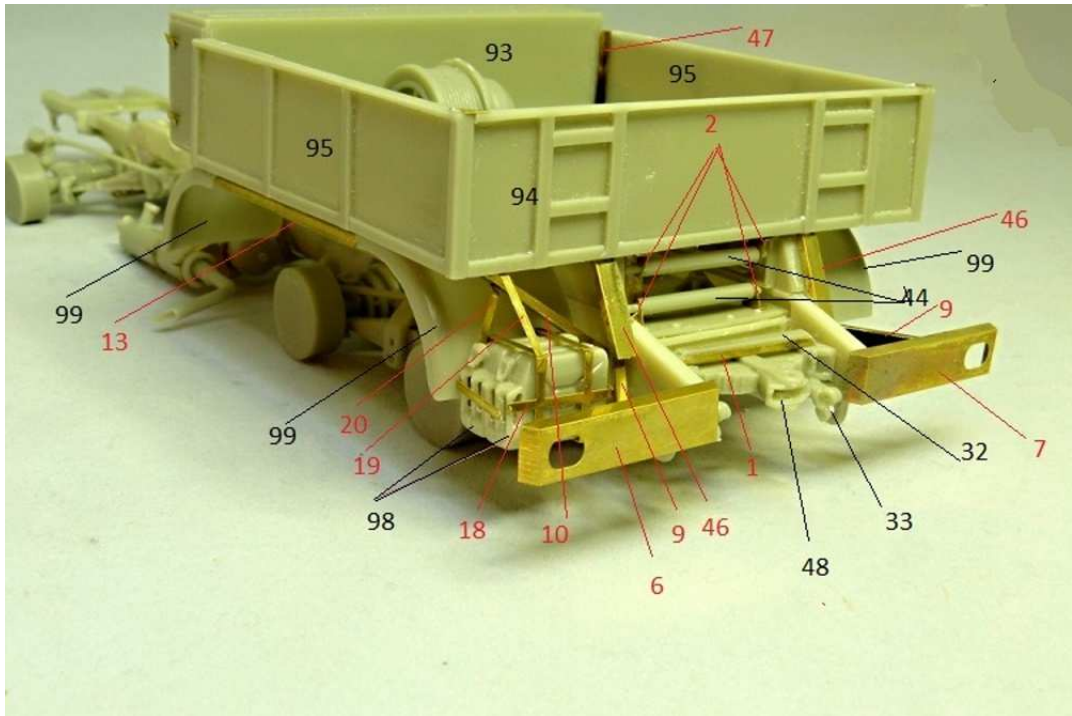
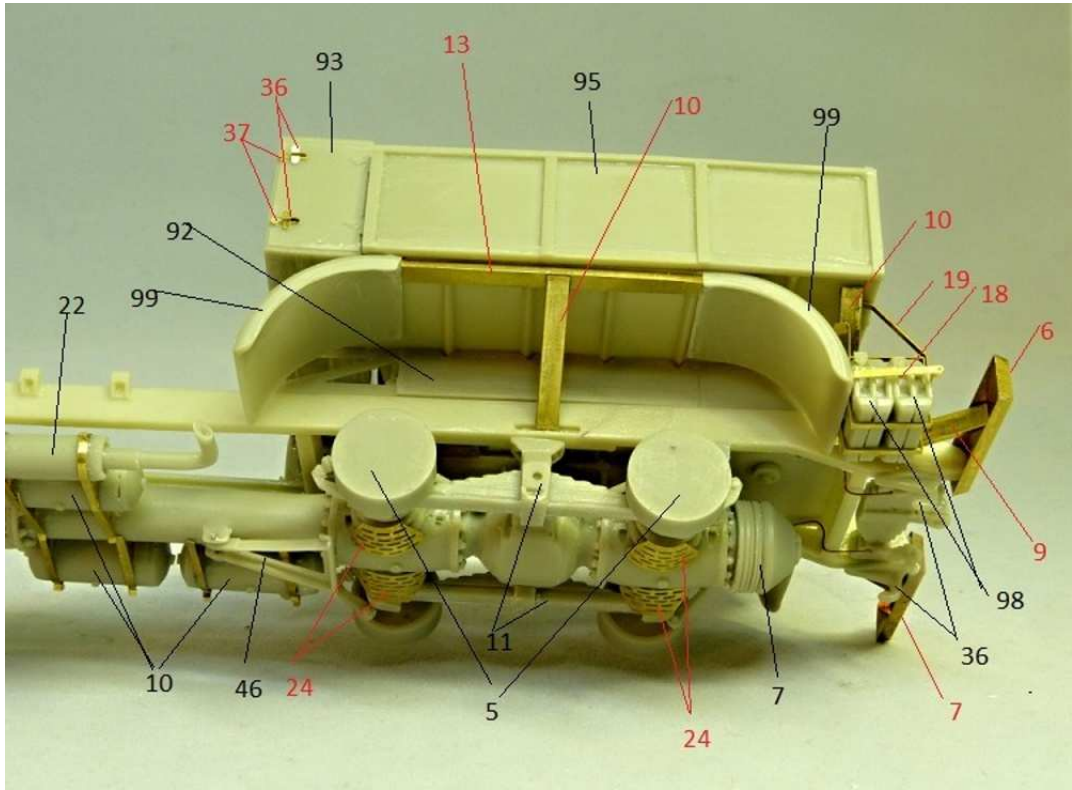

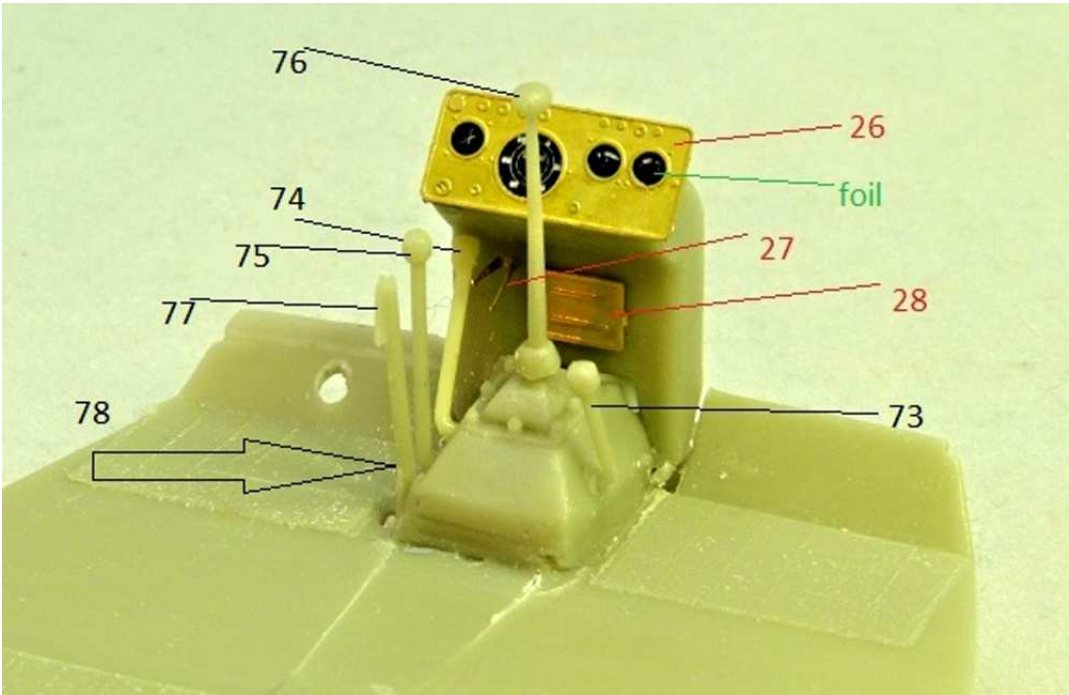
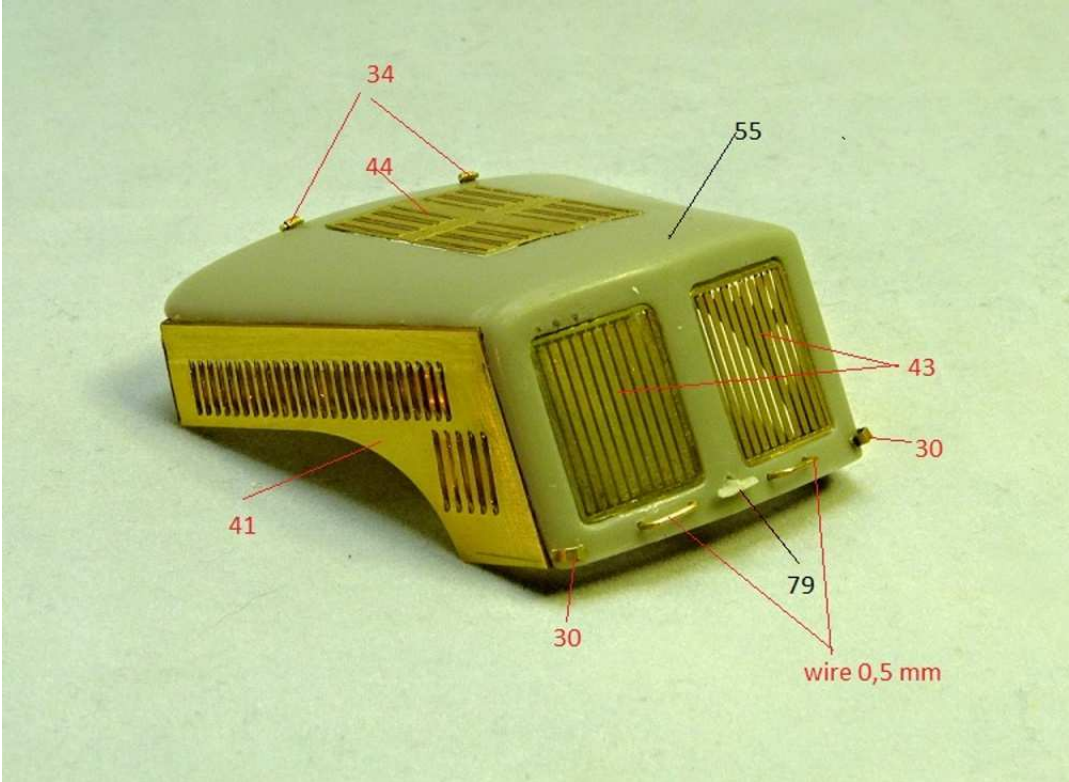

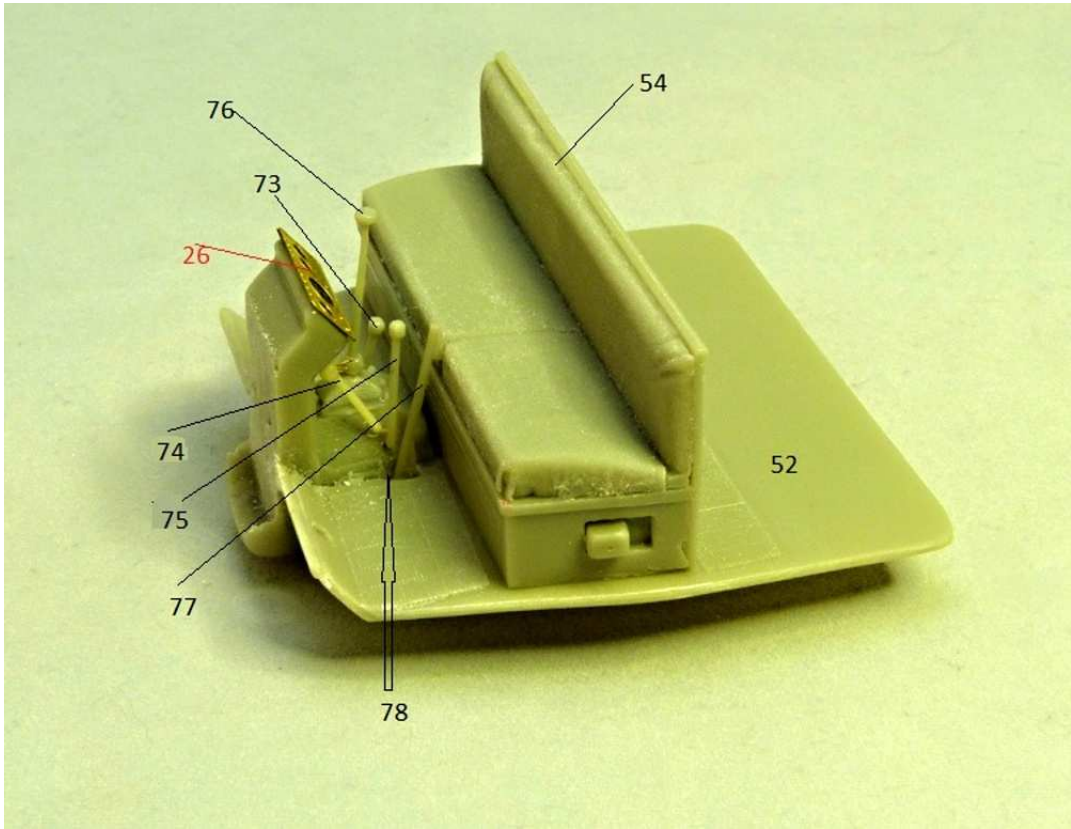
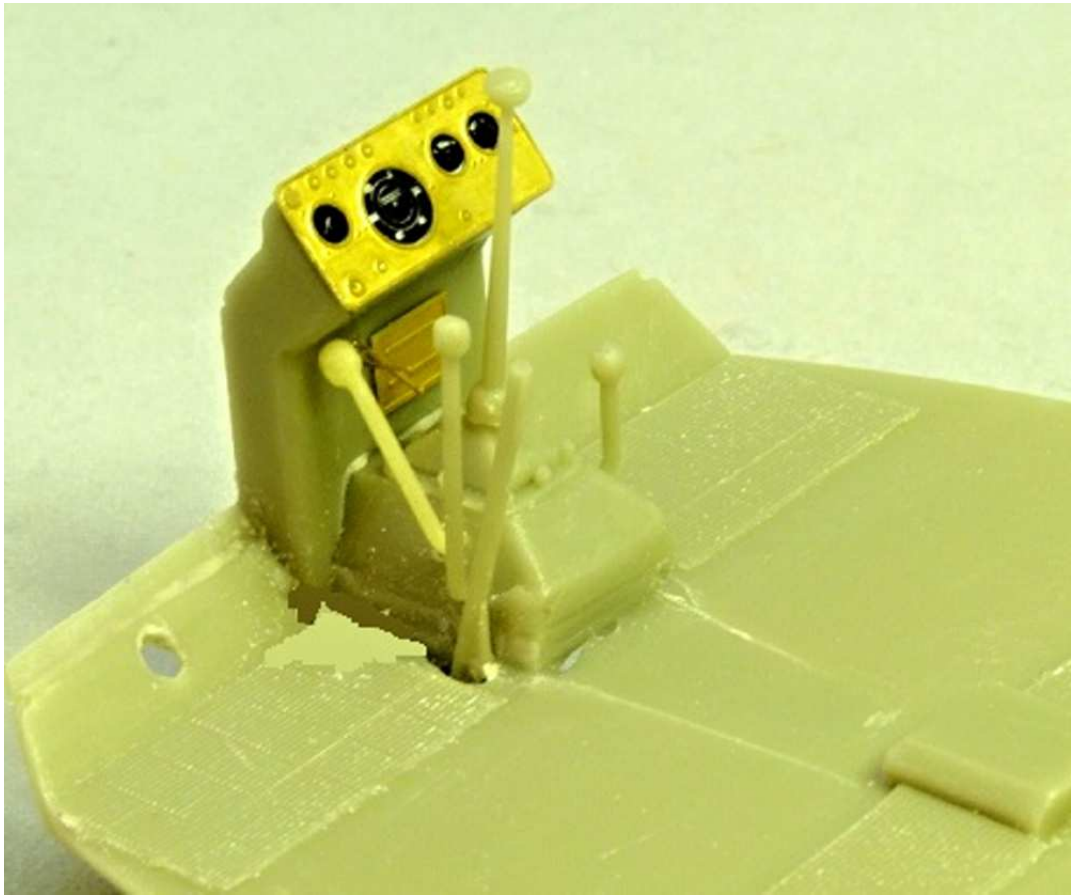

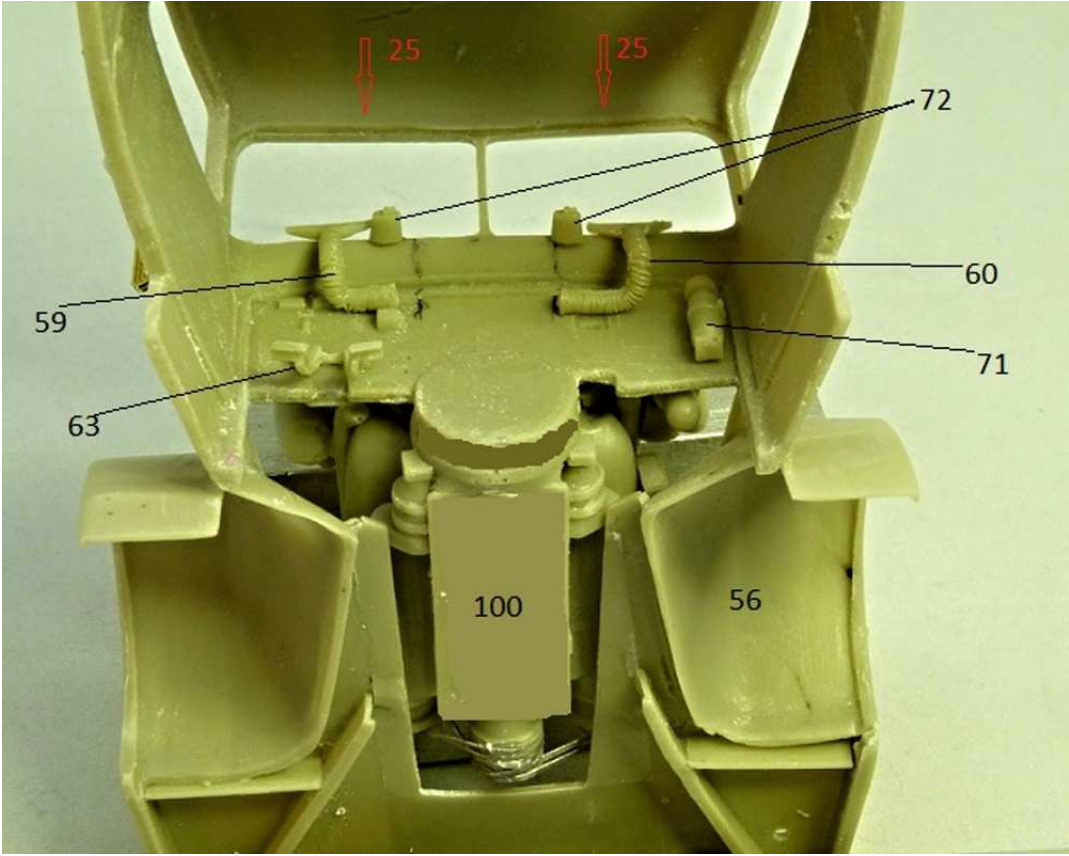

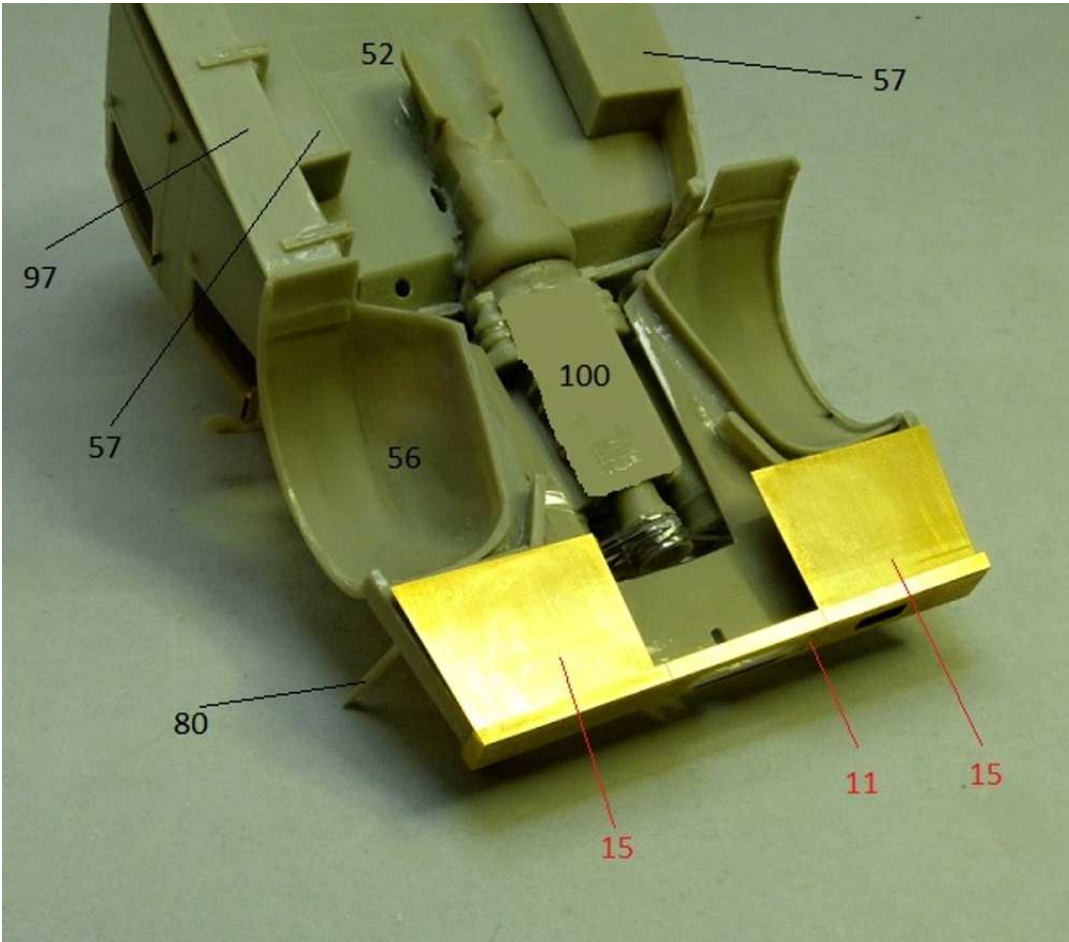
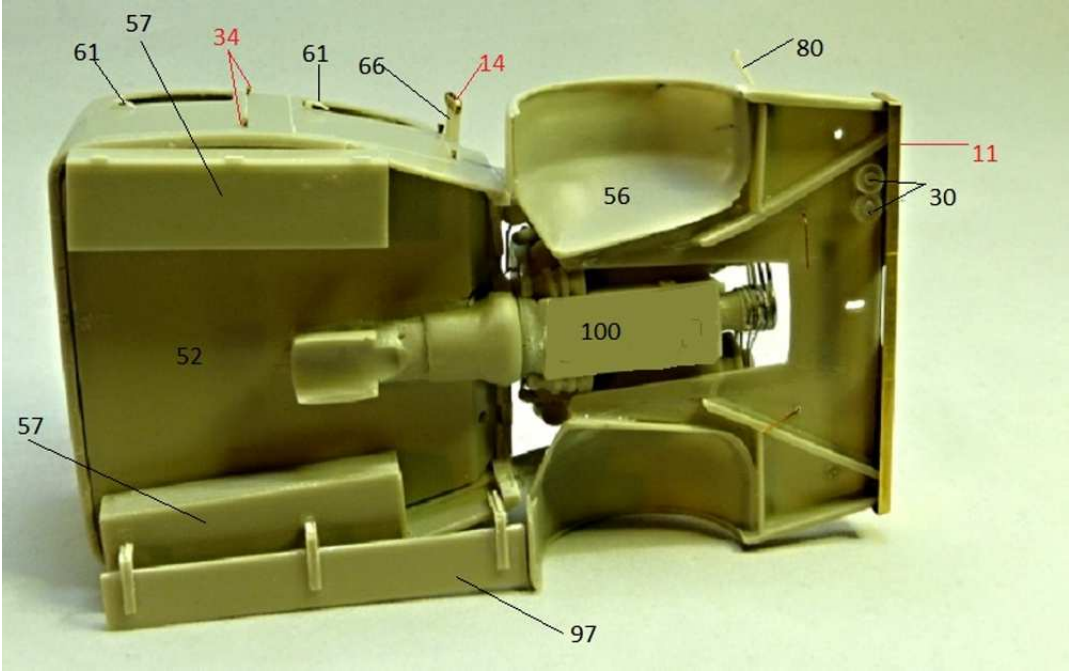

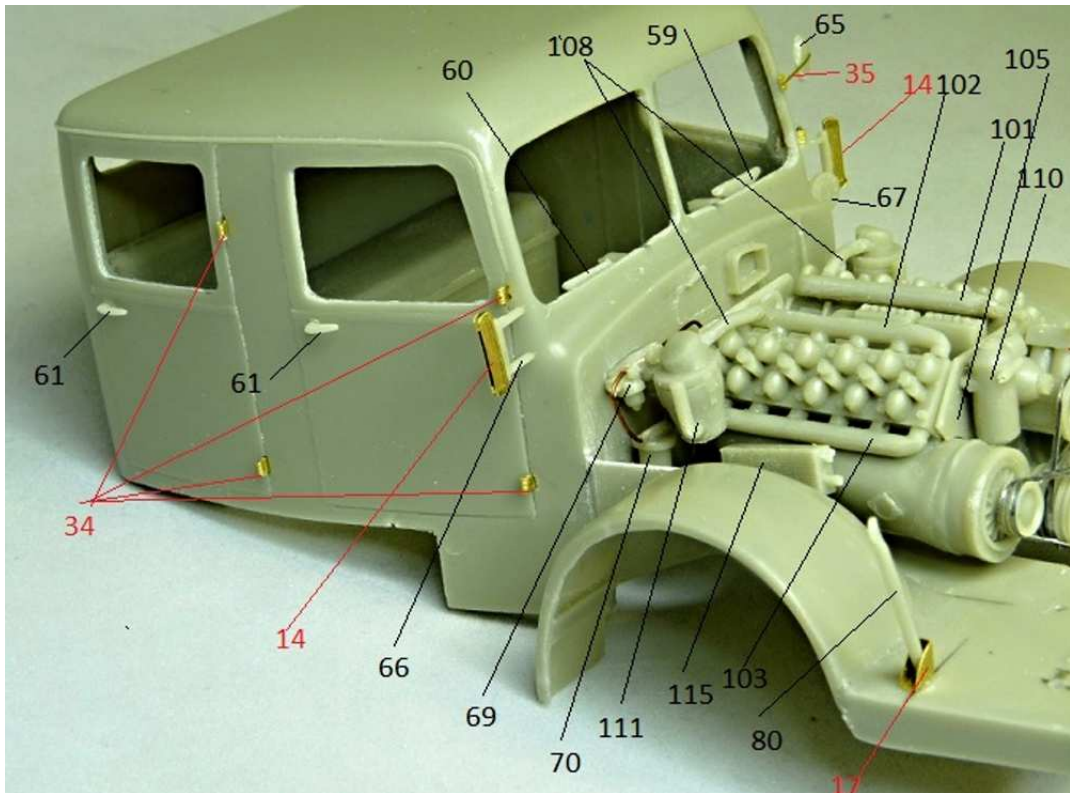
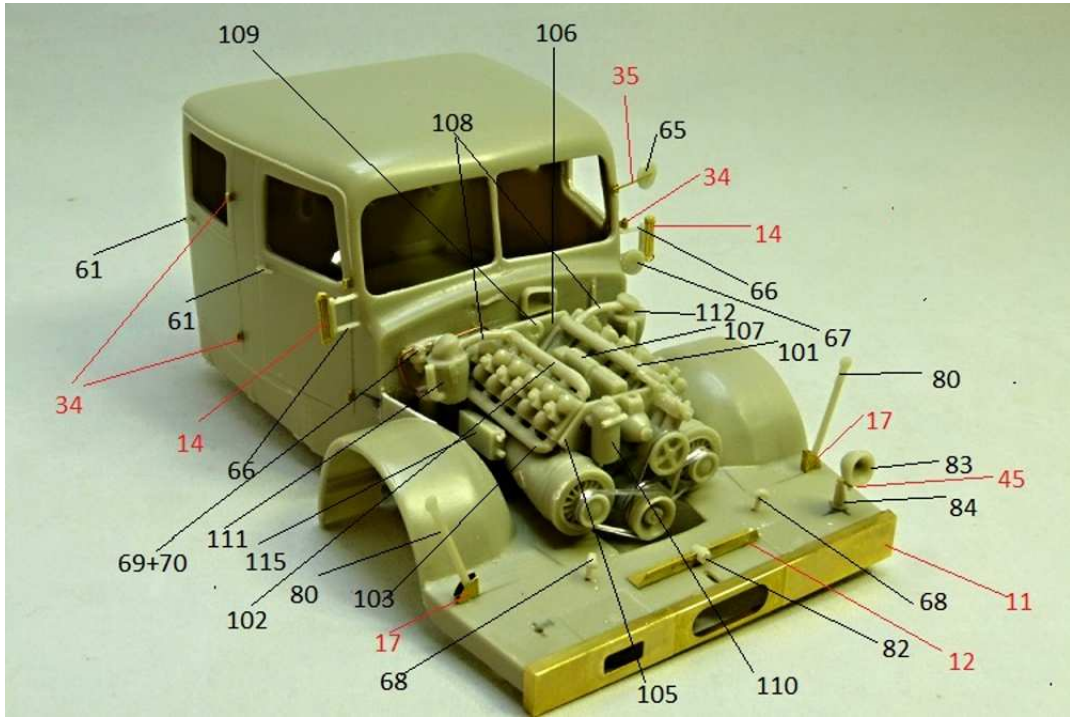

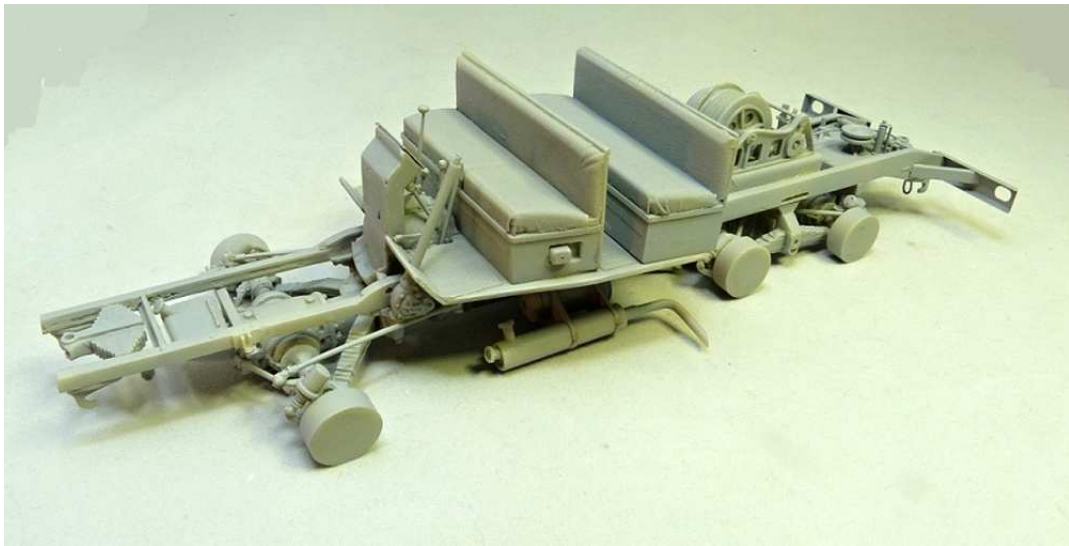



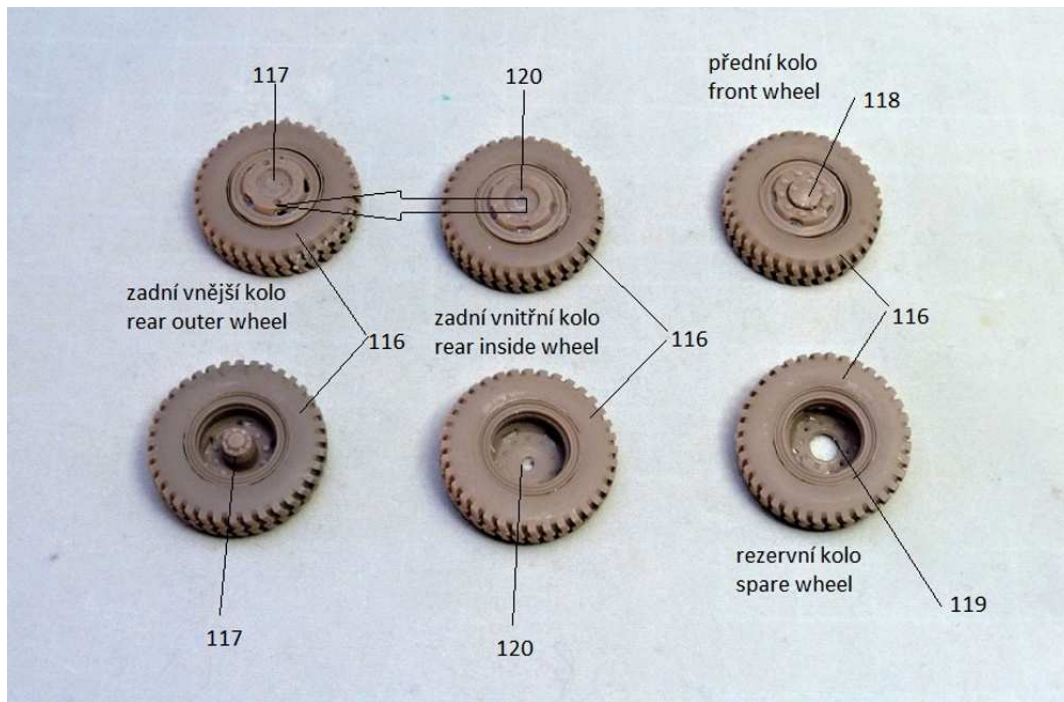



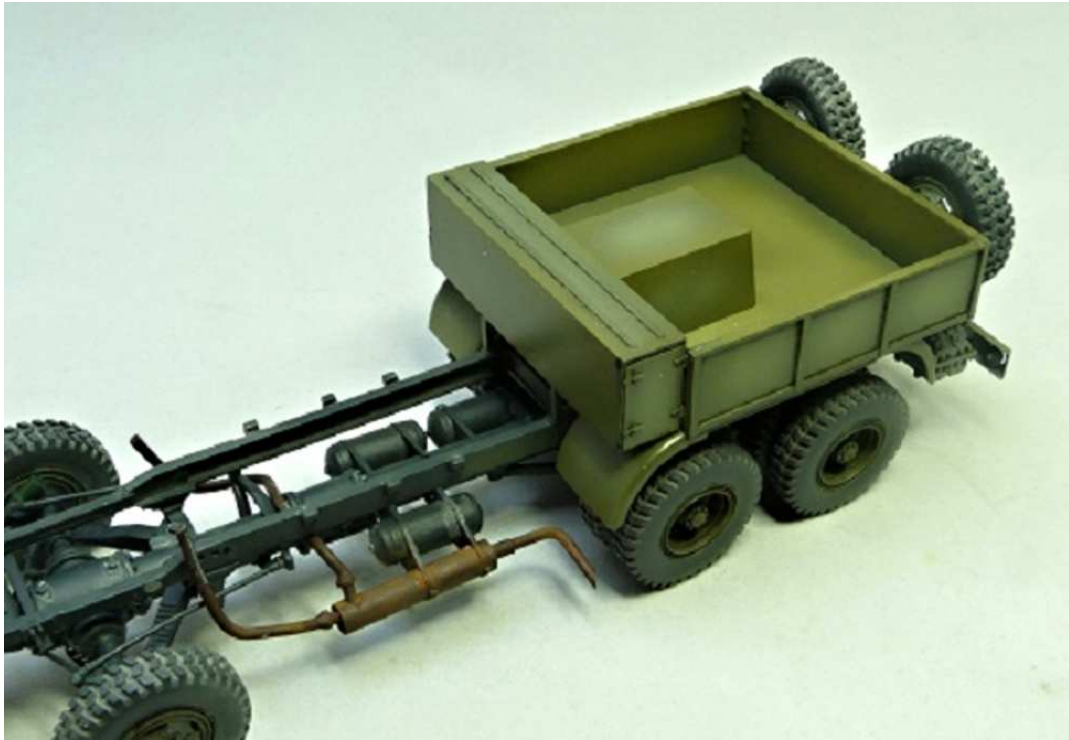







Československá státní automobilová doprava - ČSAD



Stavby Silnic a Železnic (restaurovaný veterán) - SSŽ

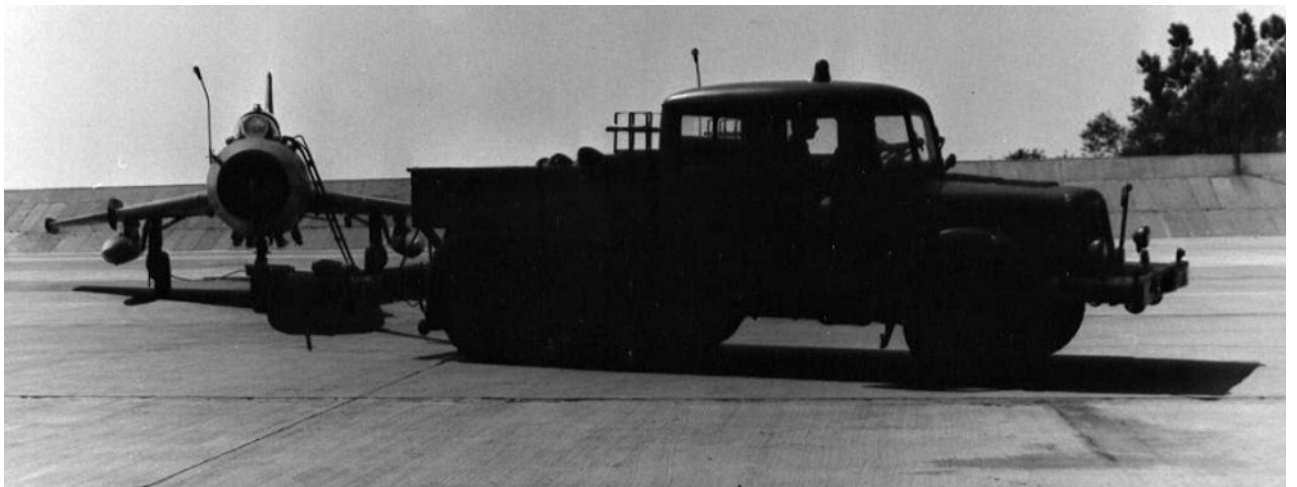

Československá lidová armáda - ČSLA



ČSLA



Wojsko Polske



Volksarmee DDR- VA



Deutsche Raichsbahn - DR