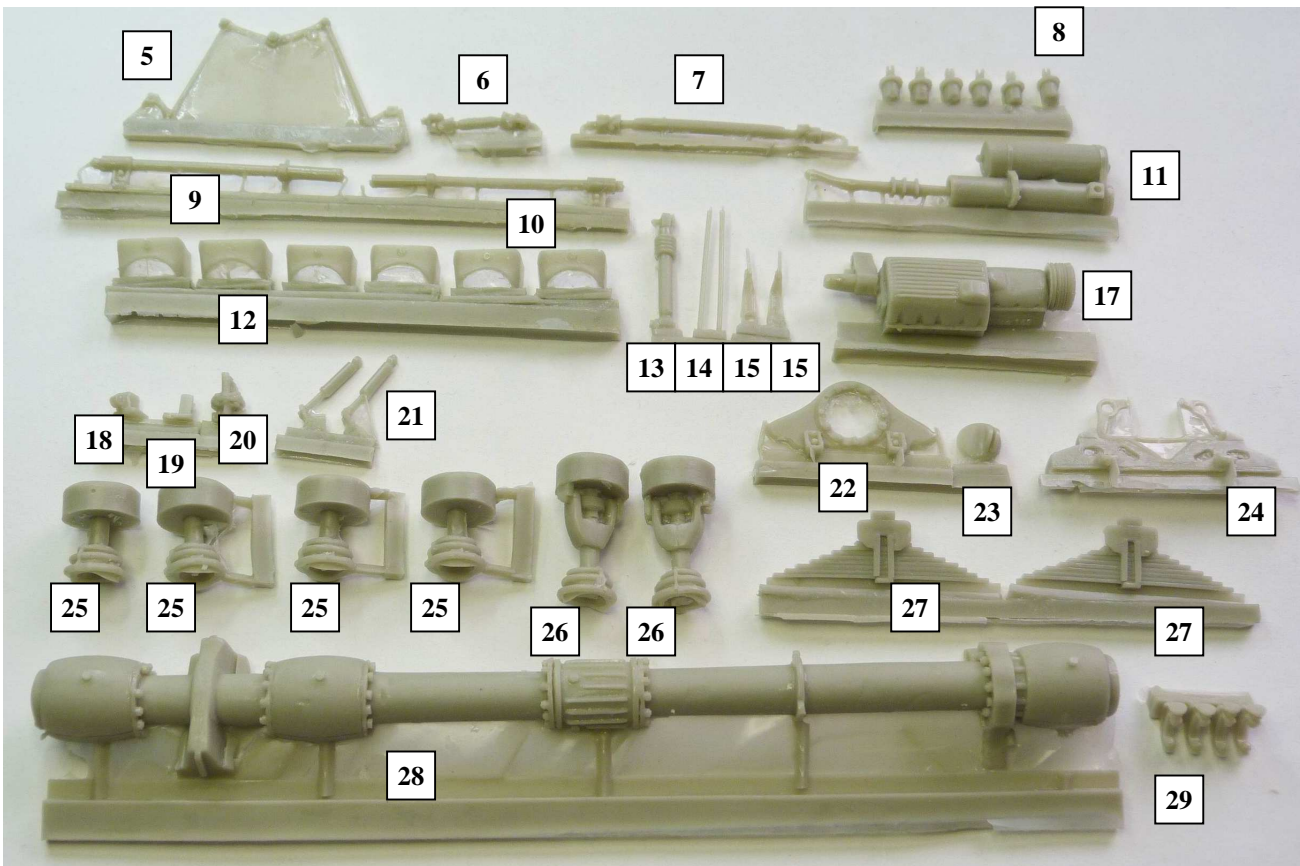
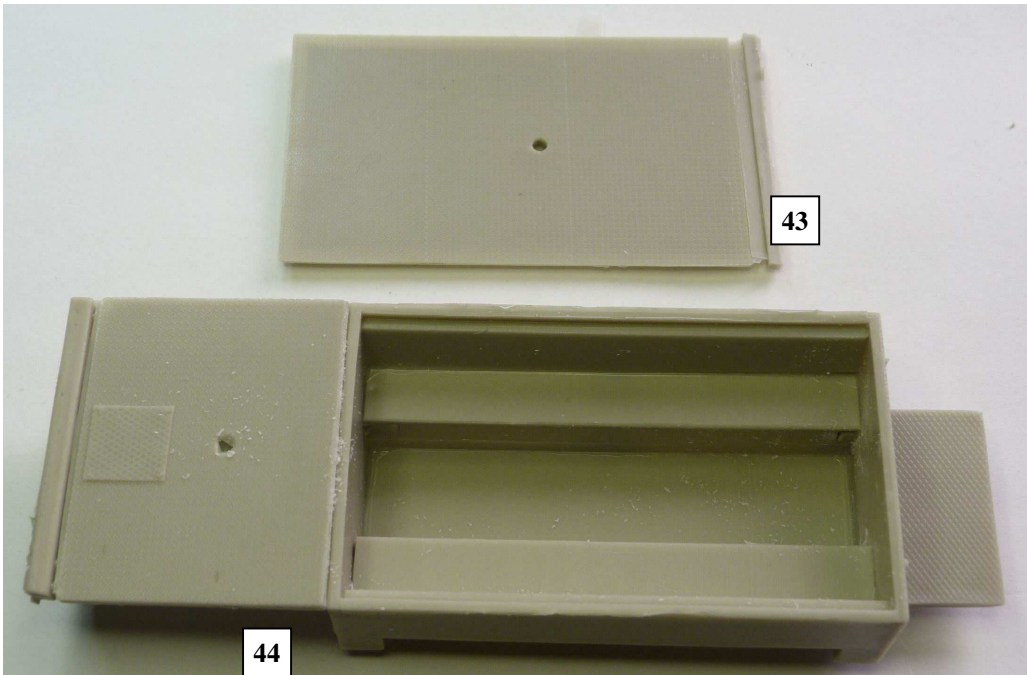
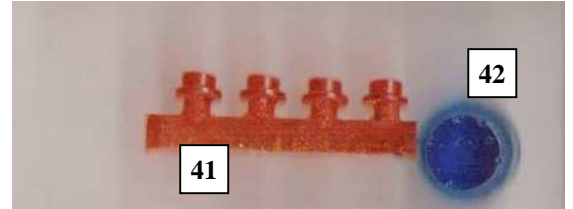
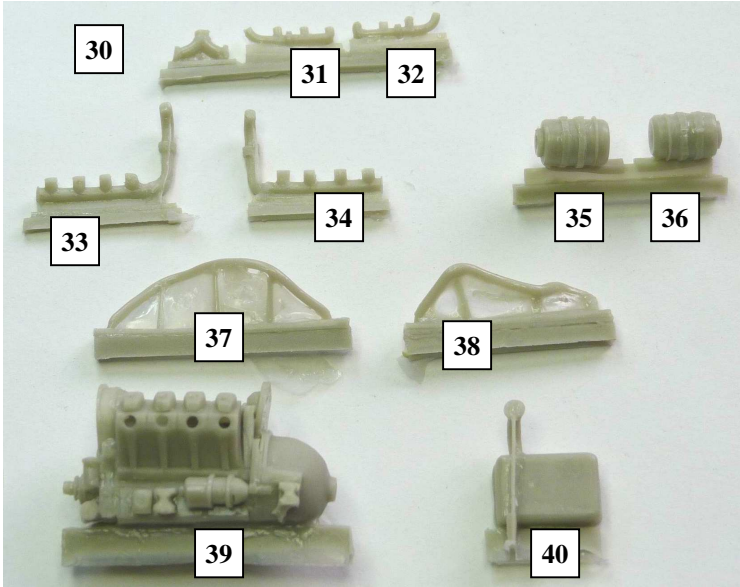
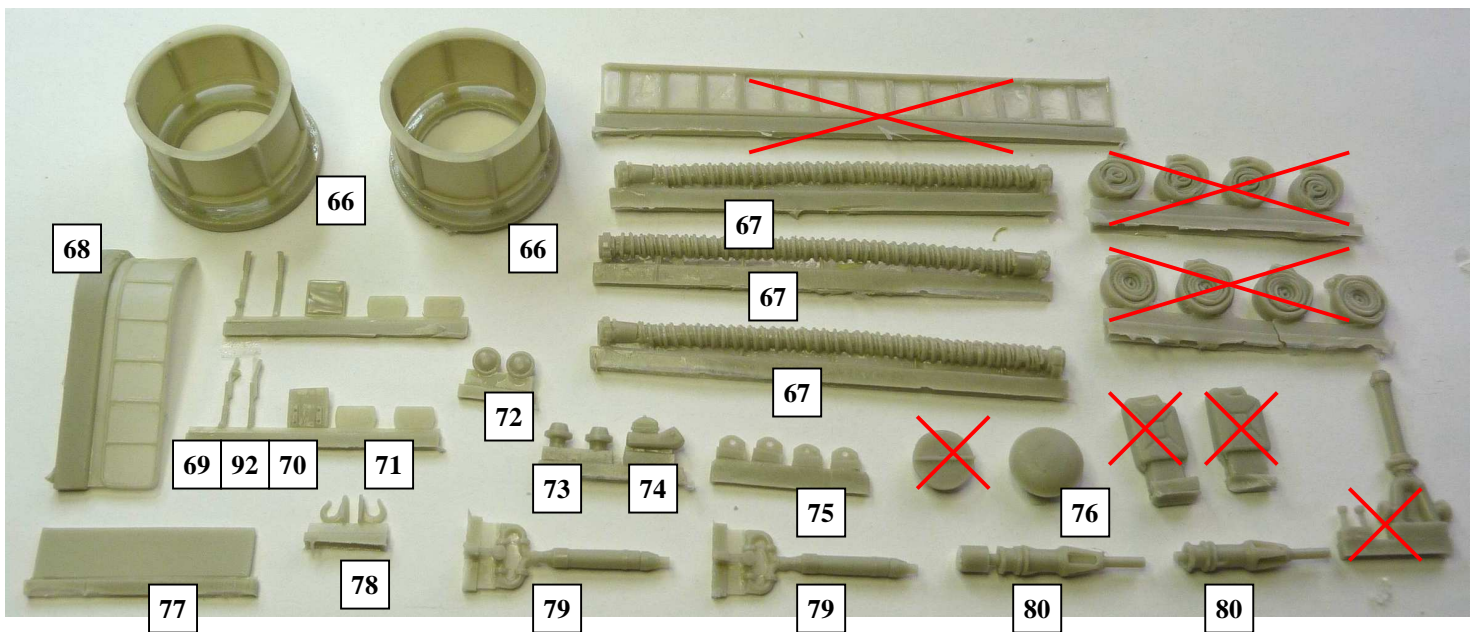
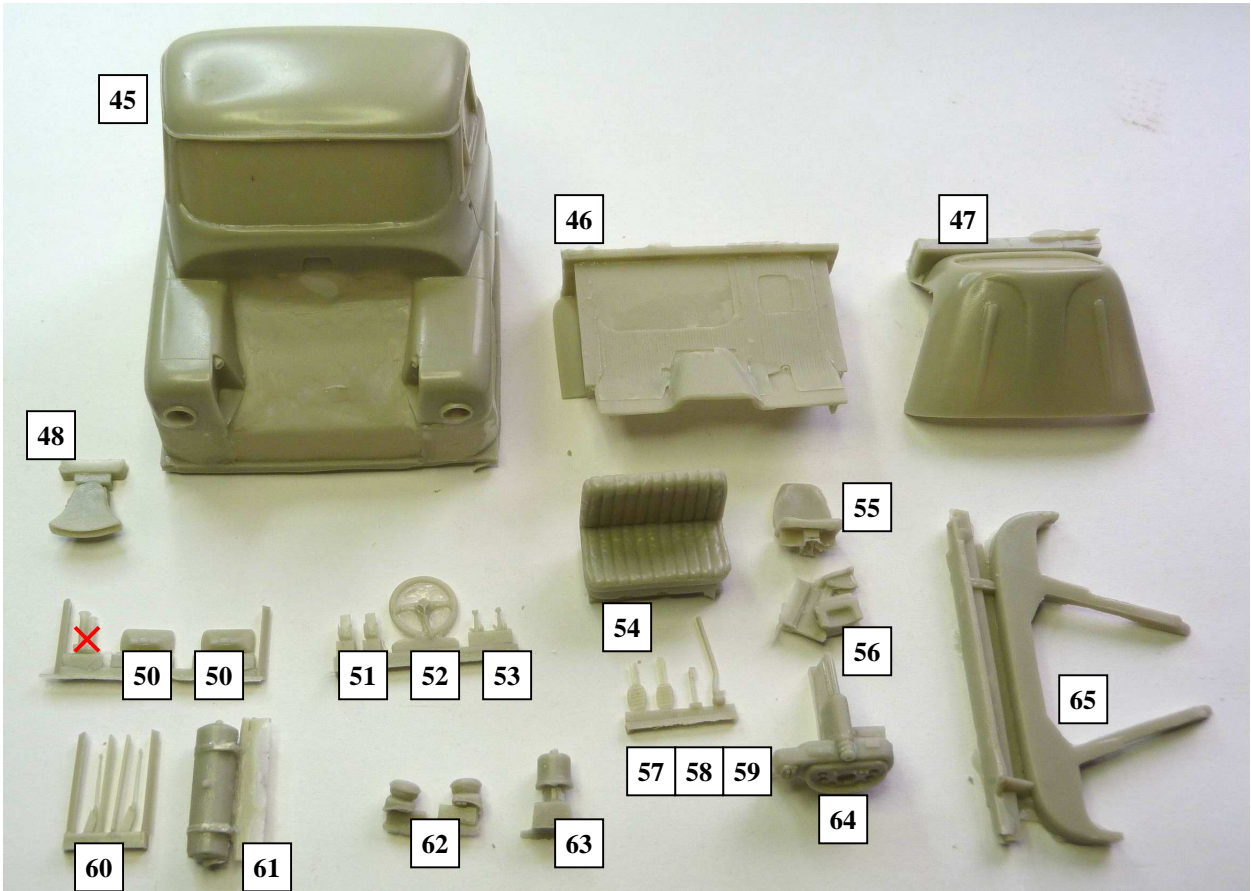


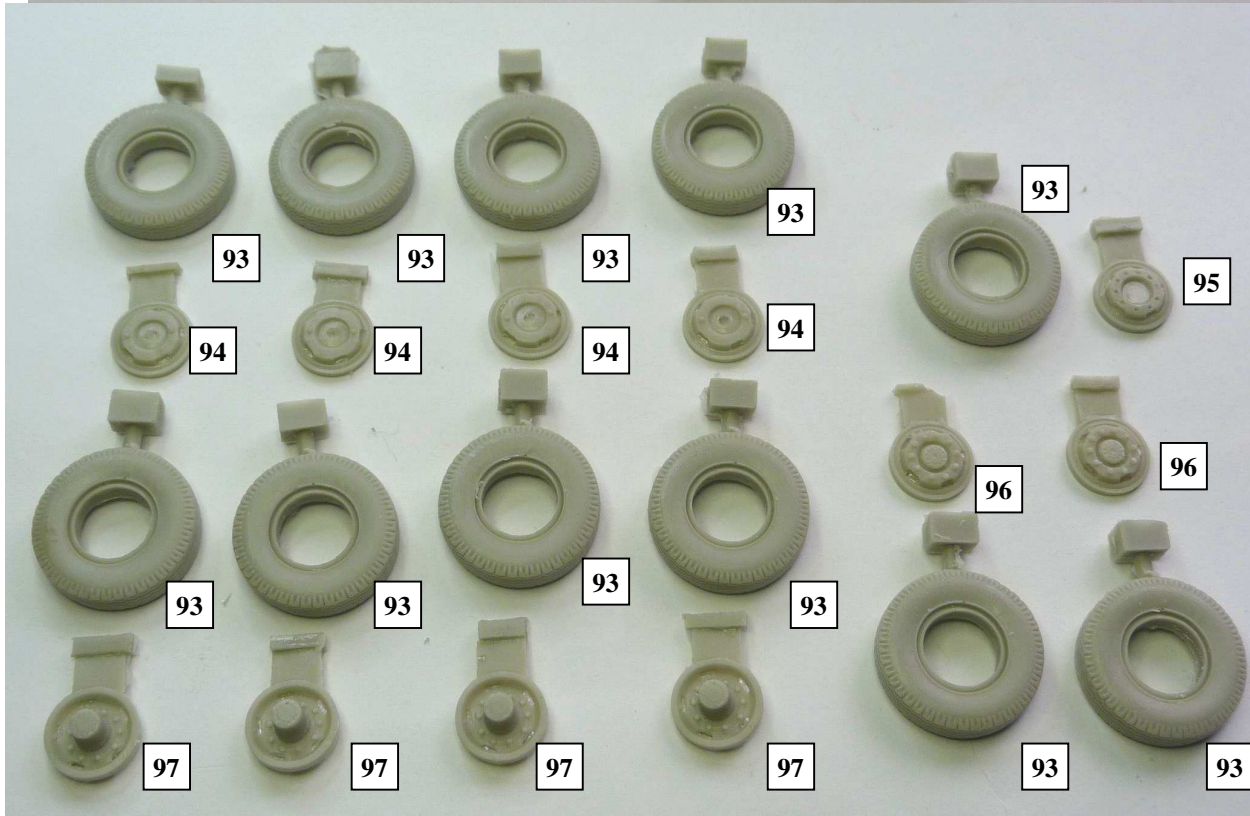
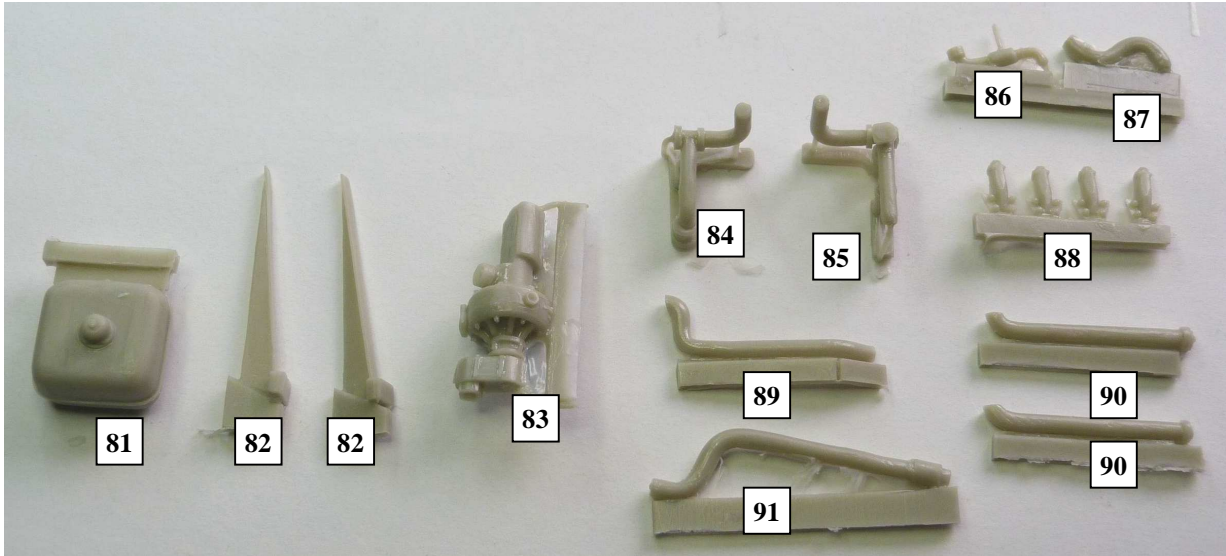


RESIN PARTS



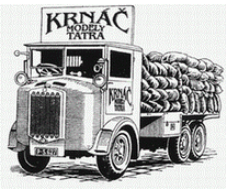




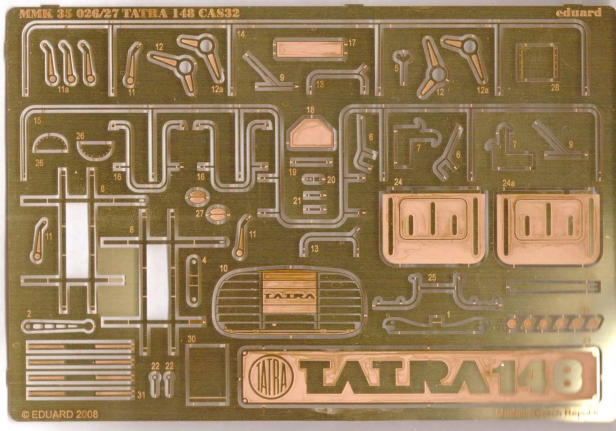


Decals

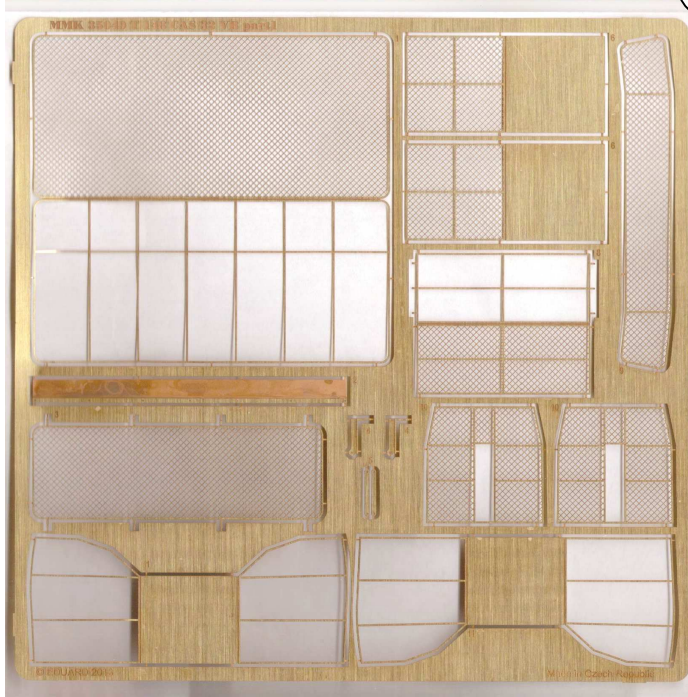




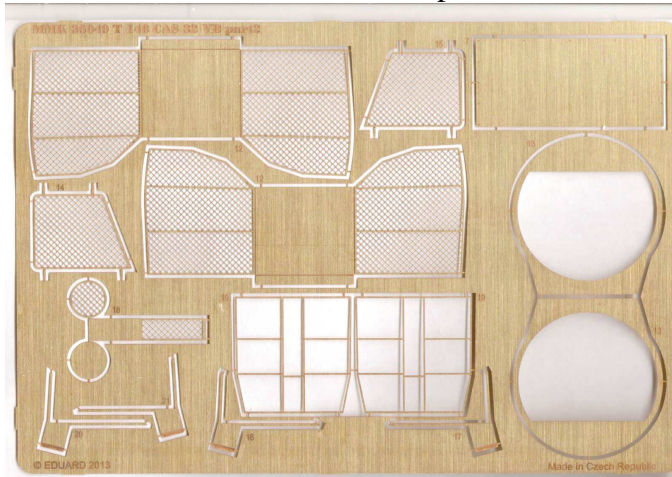
35026/27 TATRA 148 CAS32



35049 TATRA 148 CAS32 VB part1



35049 TATRA 148 CAS32 VB part2

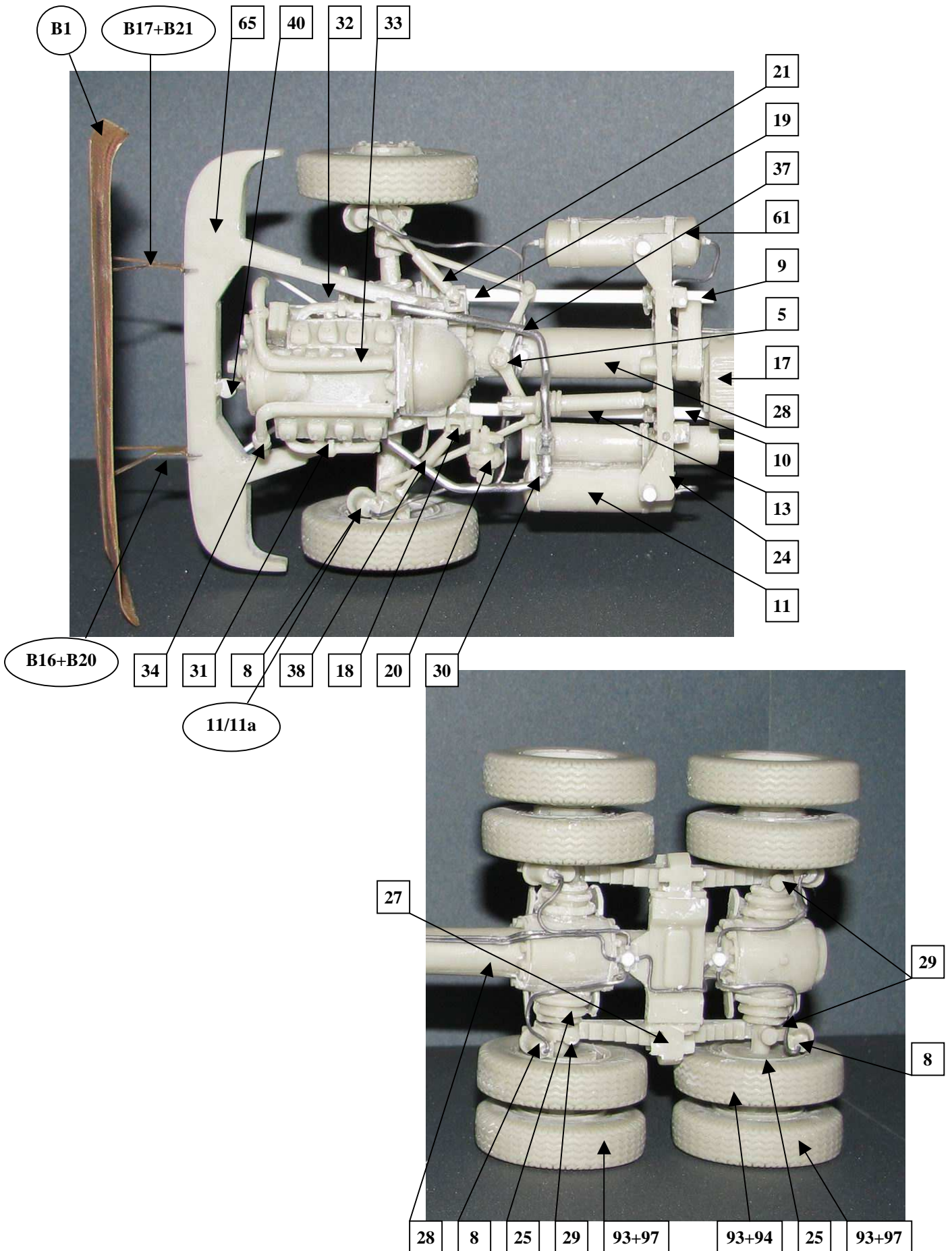
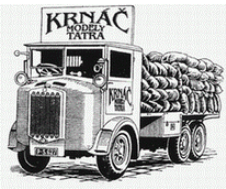


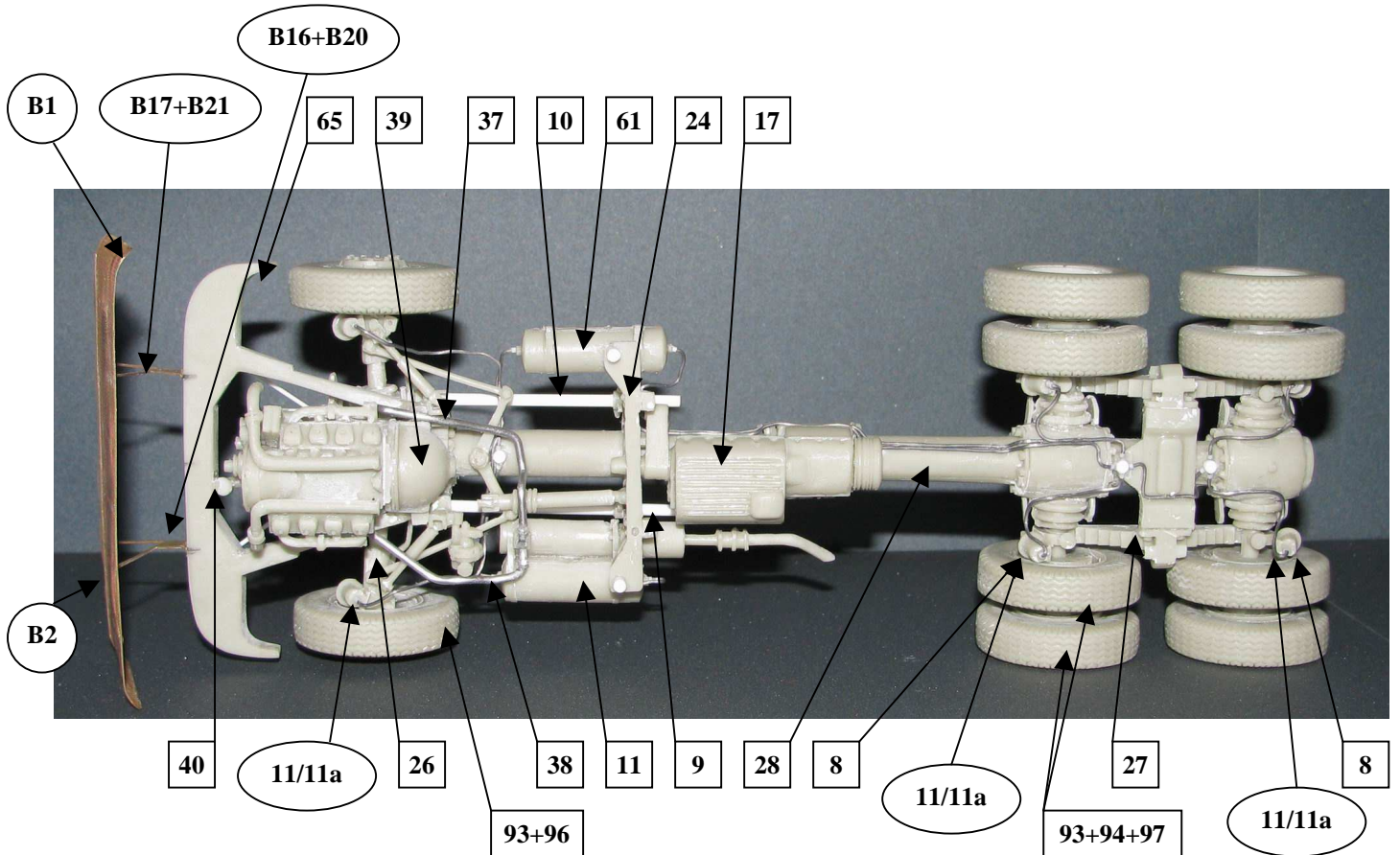
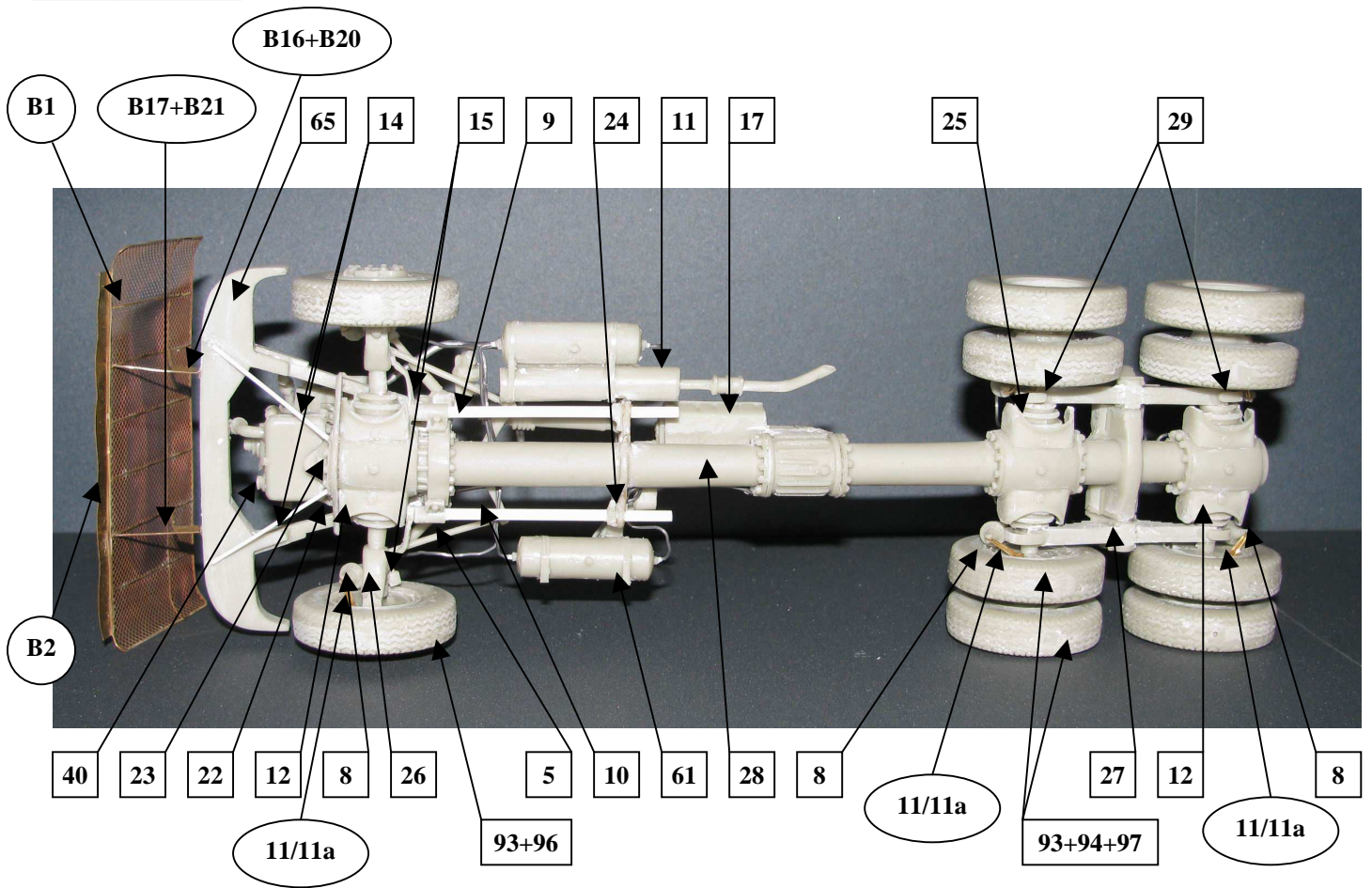
RESIN PARTS

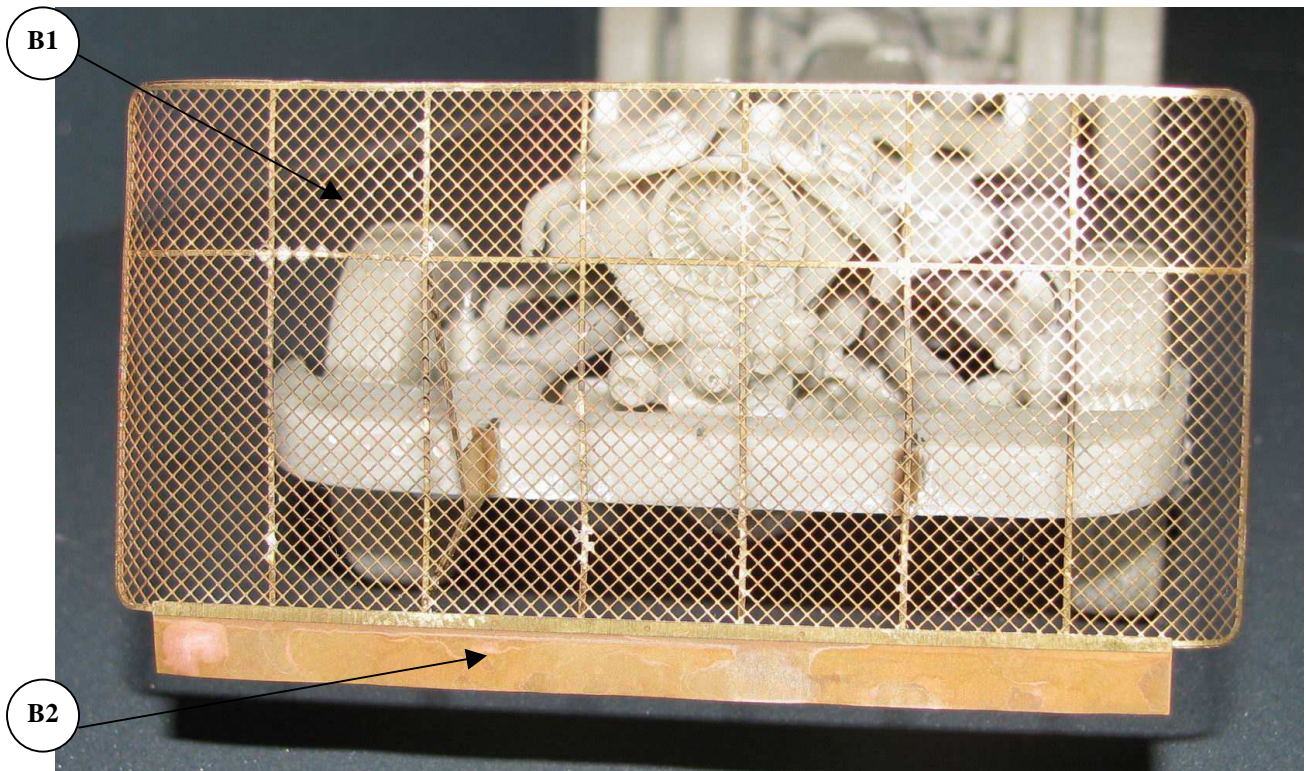
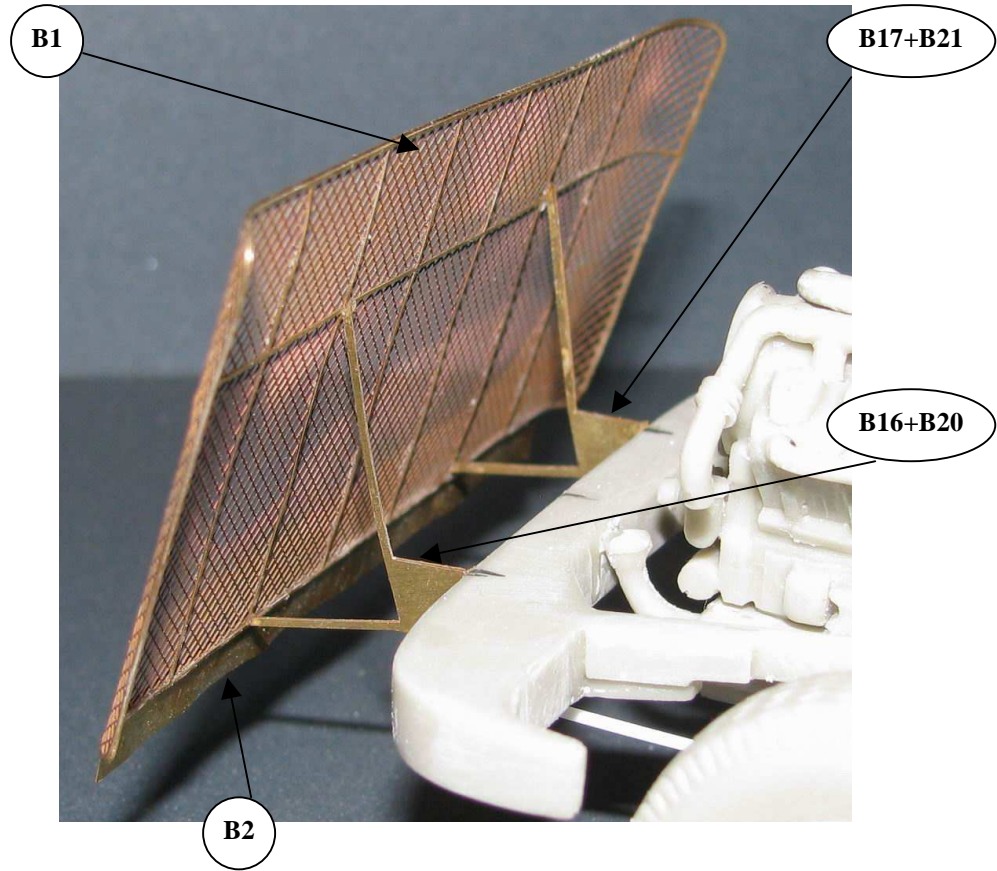
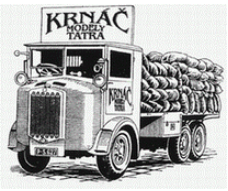


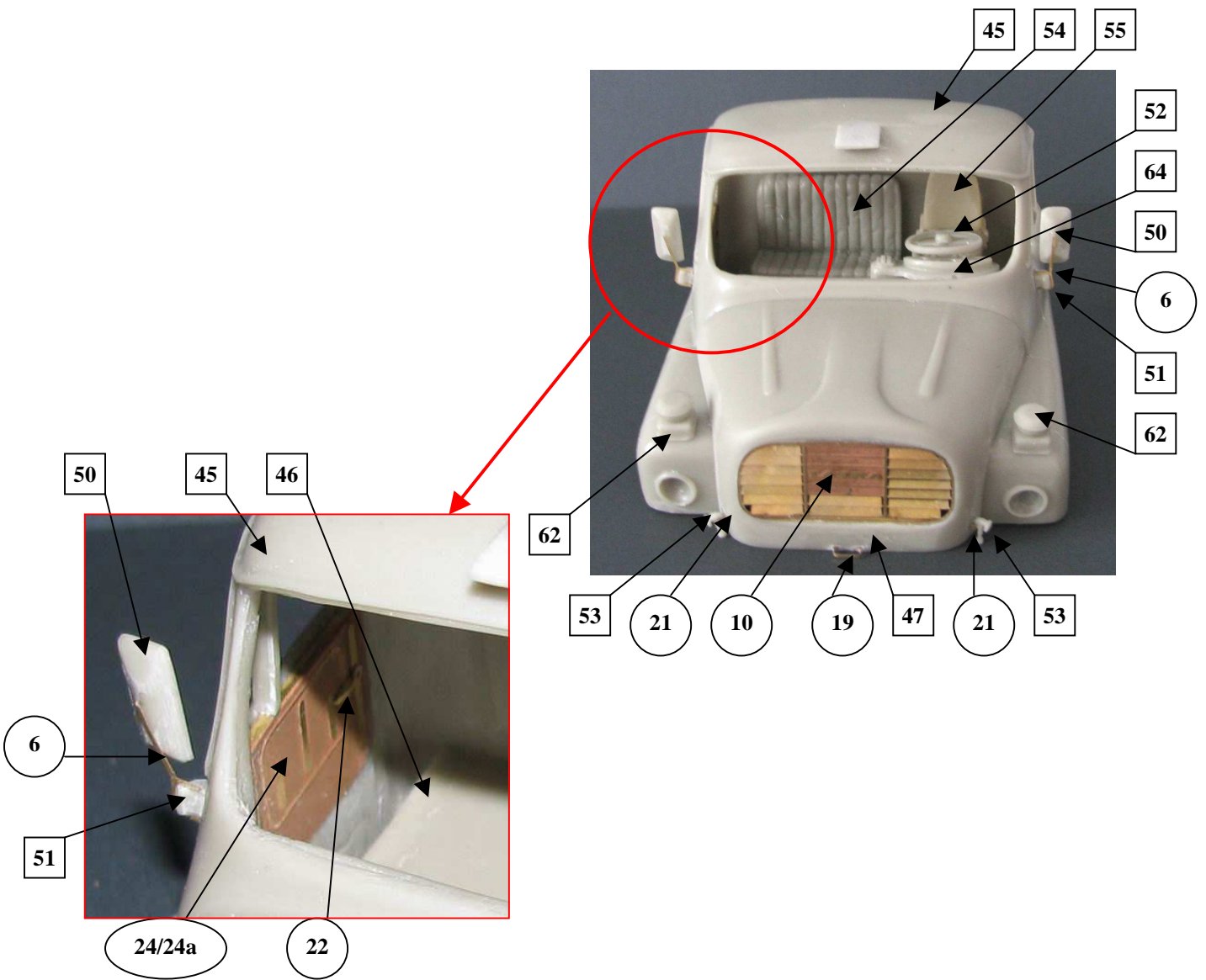
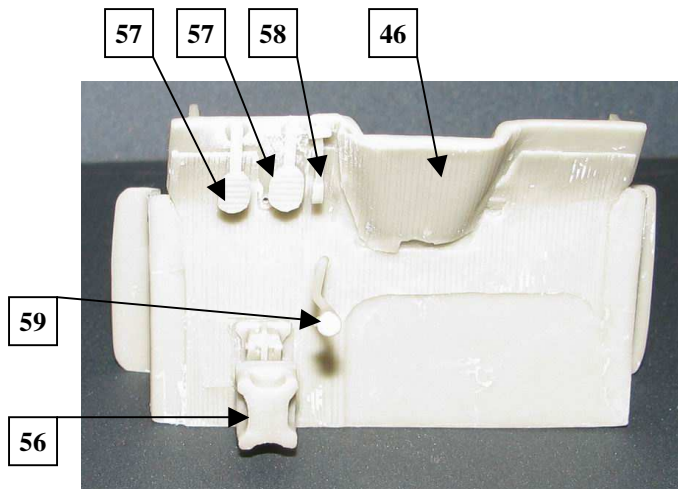
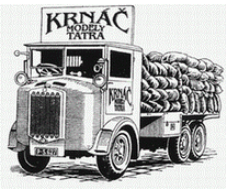
PHOTO-ETCHED PARTS





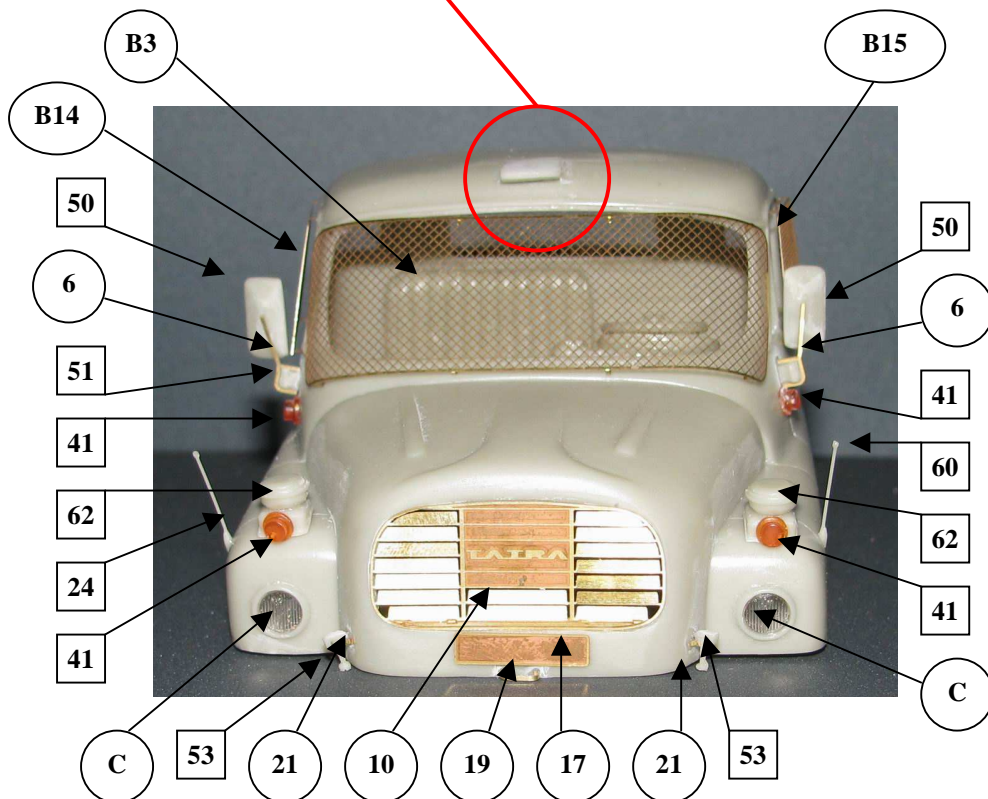
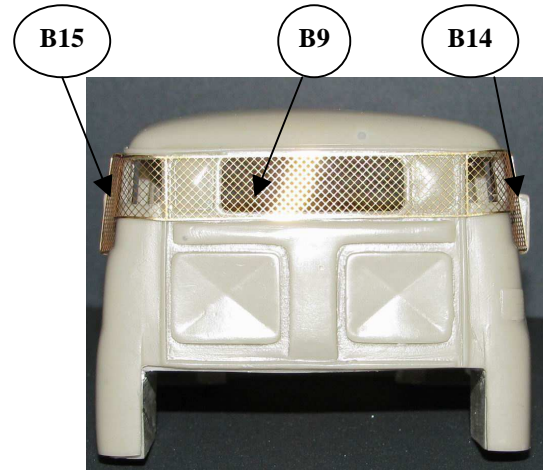
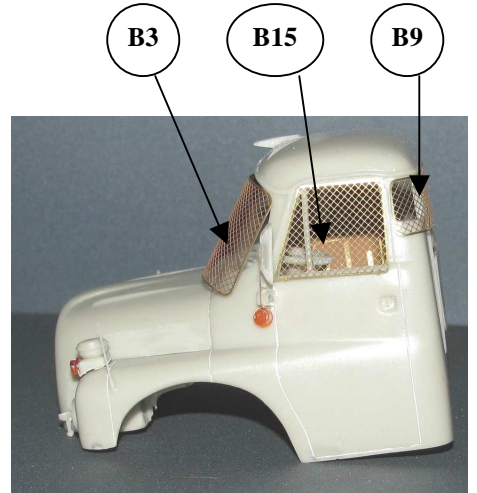
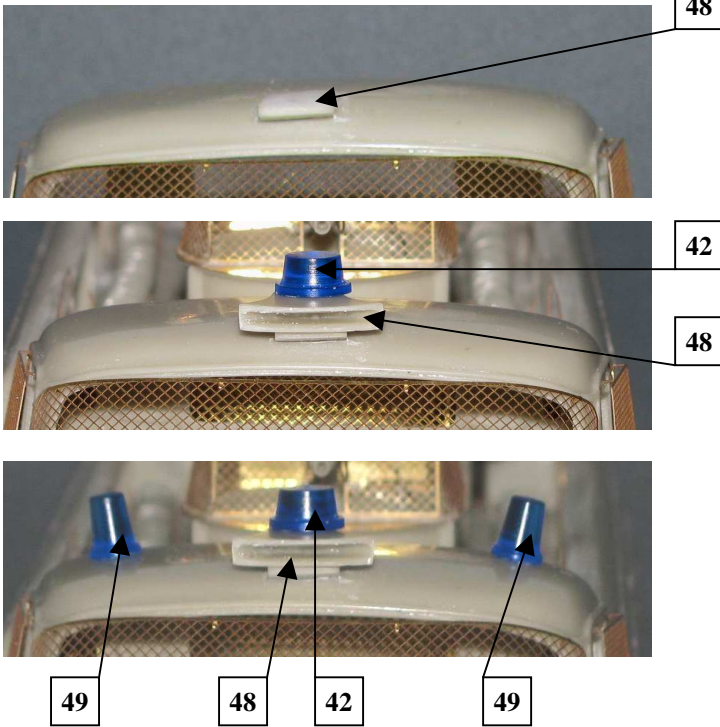


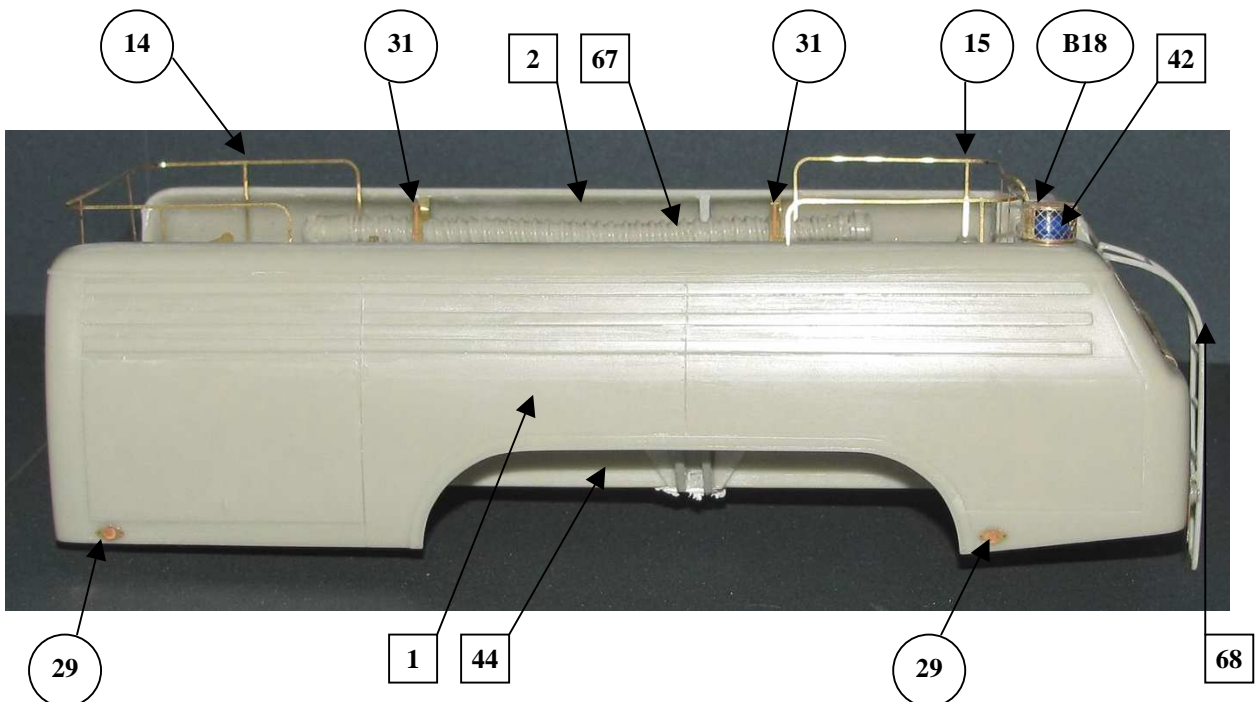
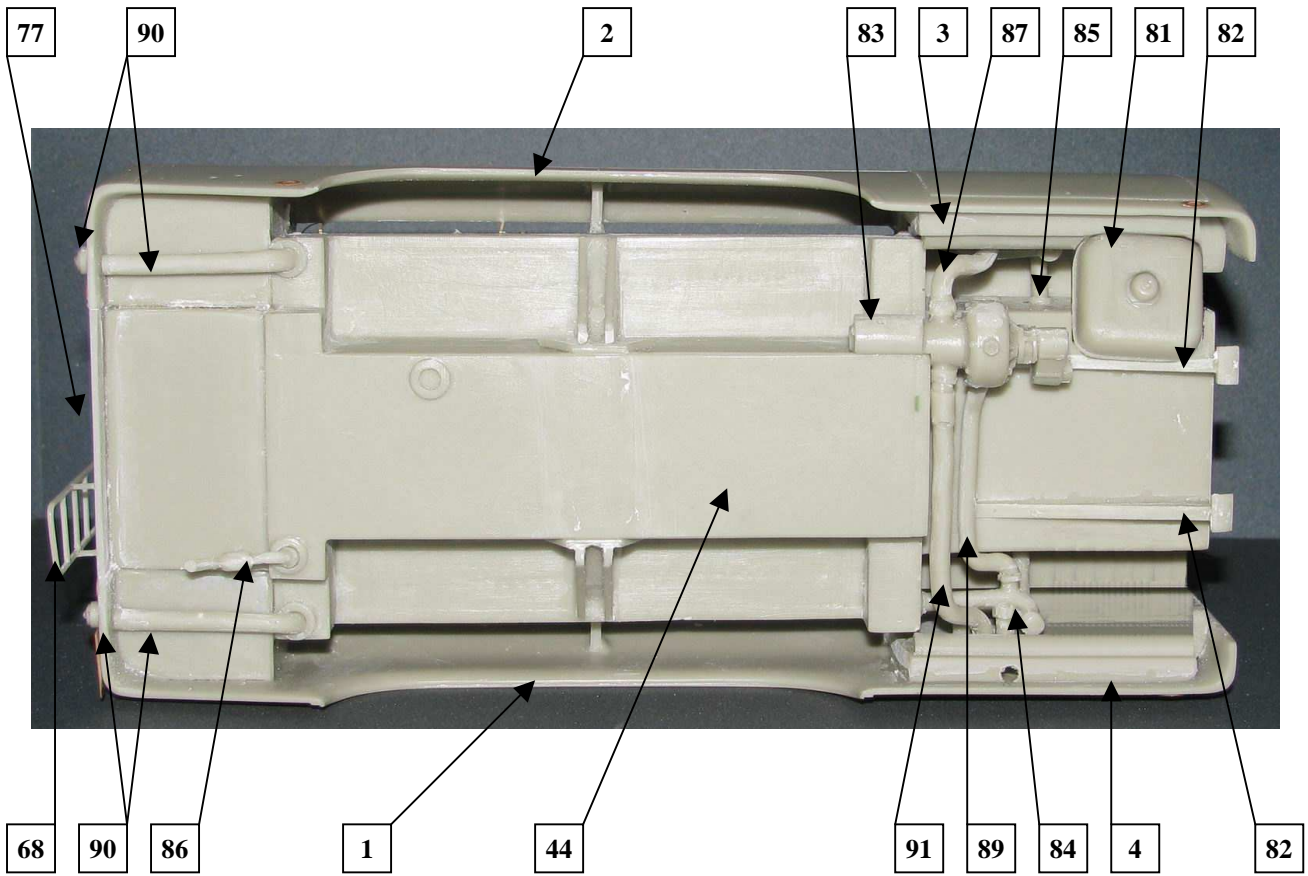


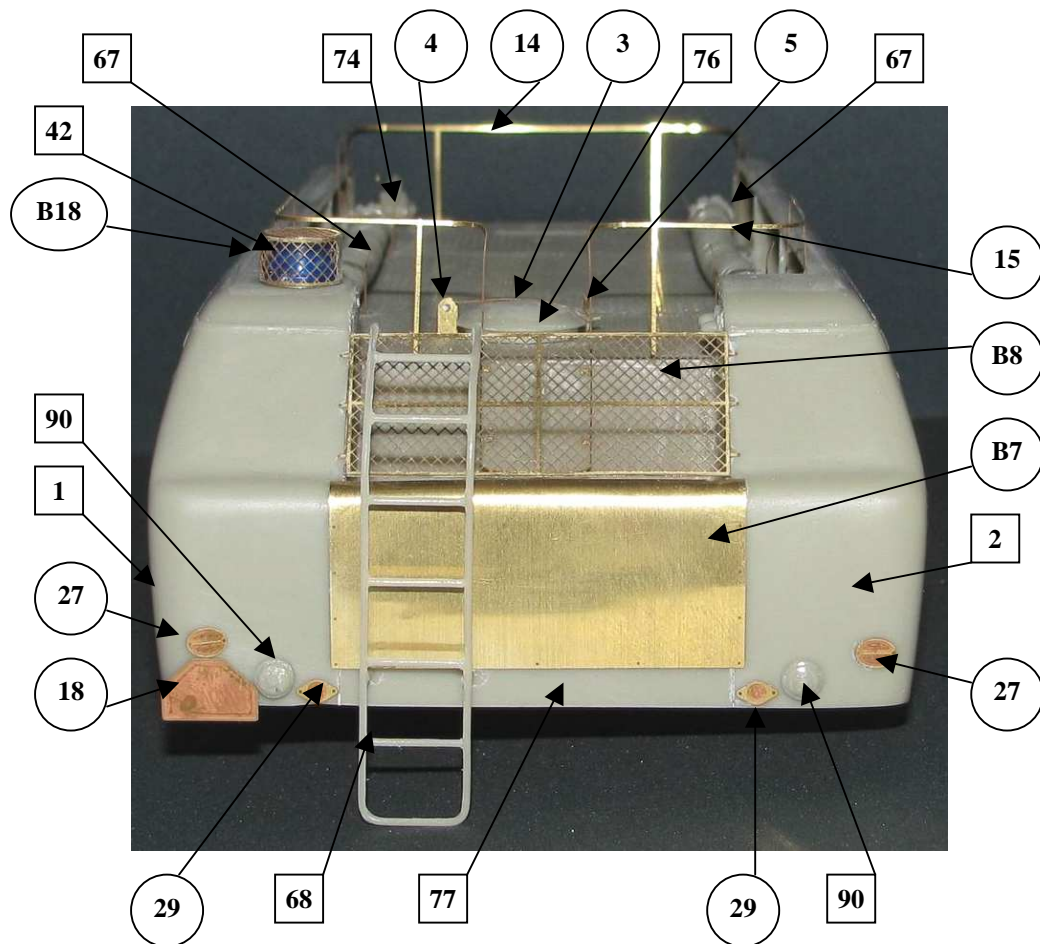
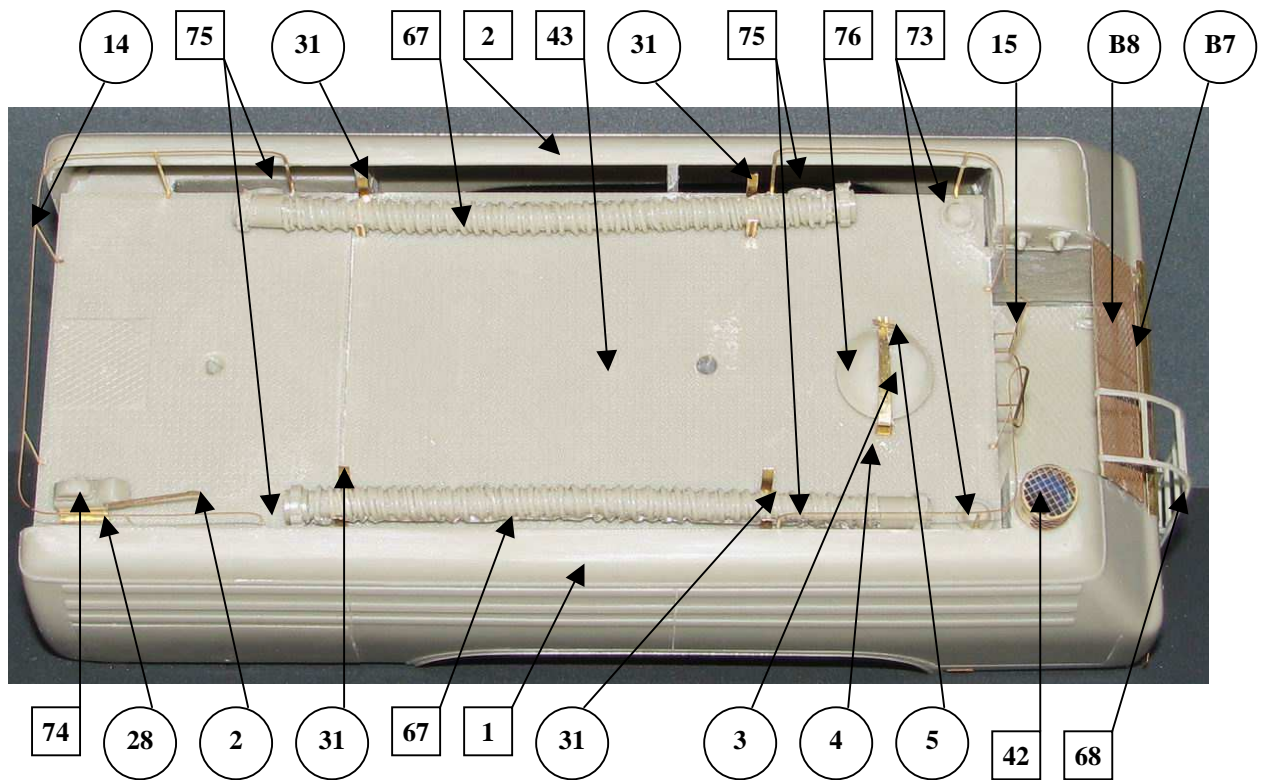
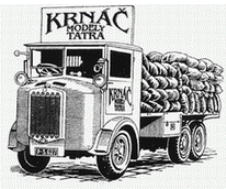


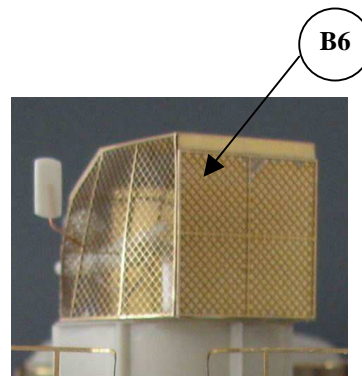
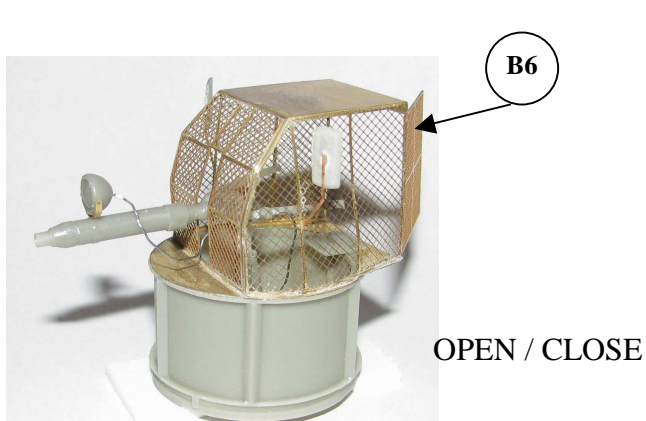
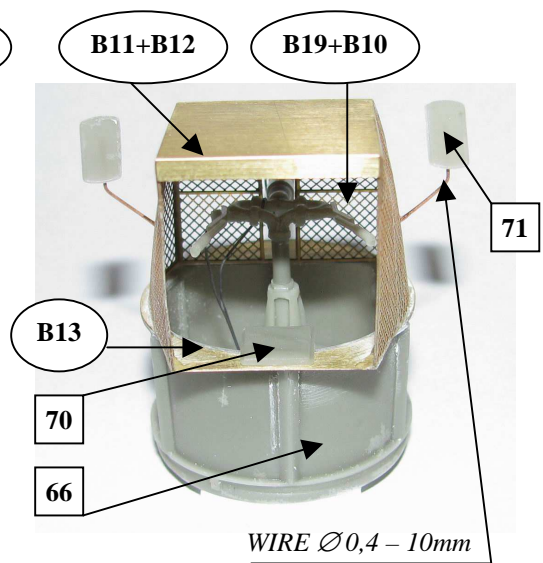
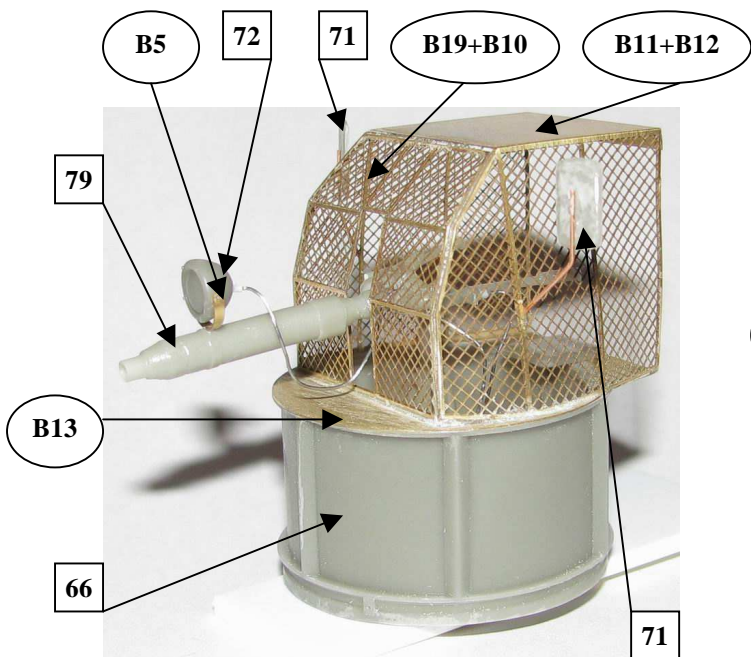
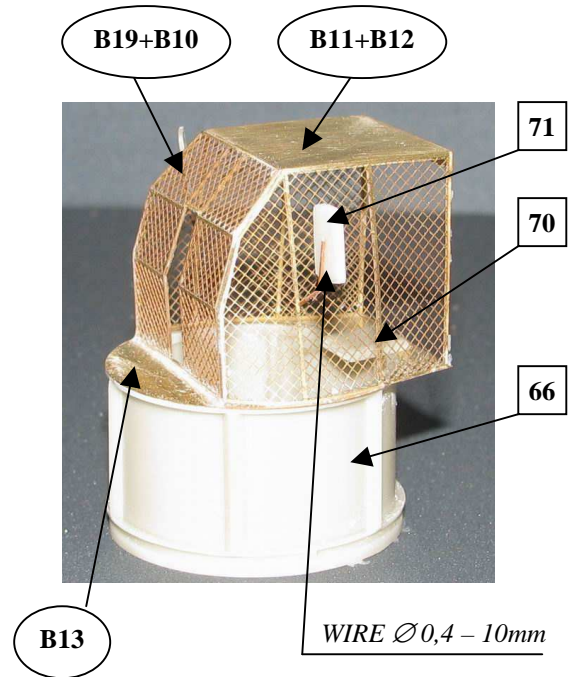
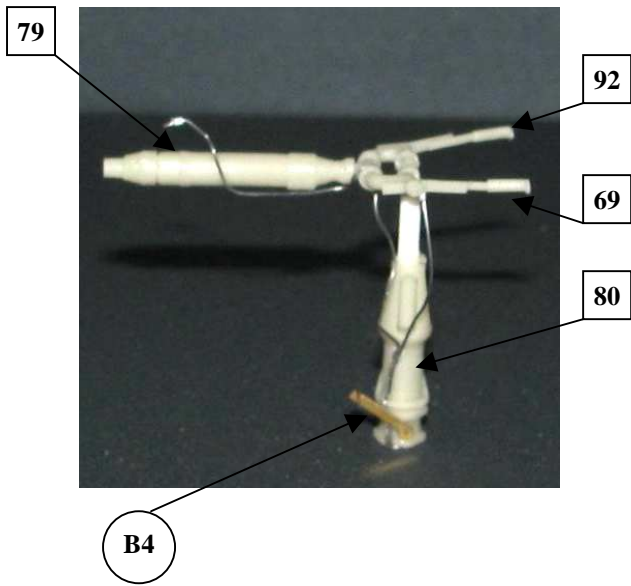
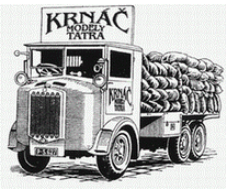


Optional:











Tatra 148 CAS32 VB

1/35

35049

14/17



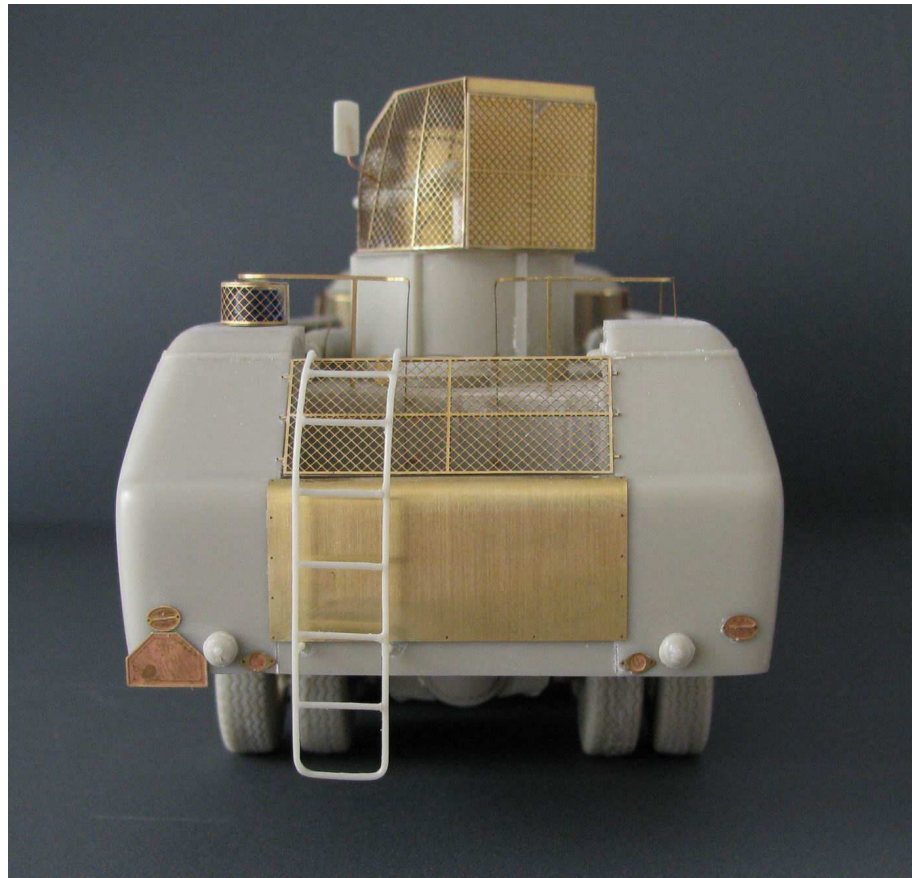


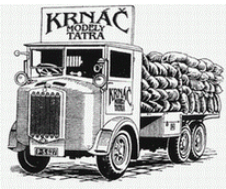
Tatra 148 CAS32 VB

1/35

35049

15/17





Tatra 148 CAS32 VB

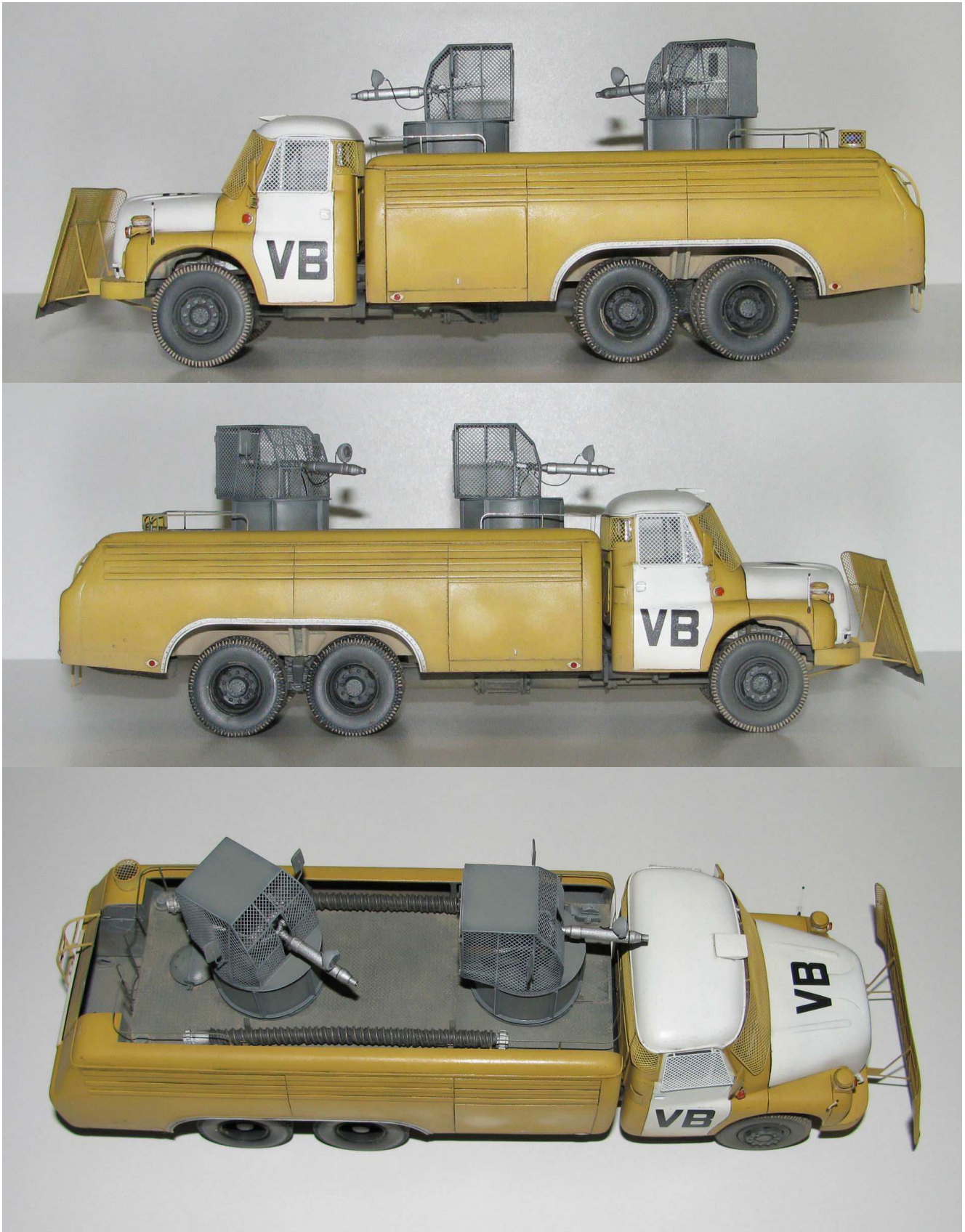
1/35

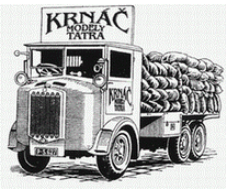
35049

16/17

Tatra 148 CAS32 VB patřící do stavu SNB, VB, Praha 1989

(SNB - Sbor národní bezpečnosti, VB – Veřejná bezpečnost)





Pozn.:

Vozidla byla používána v různých konfiguracích a zbarveních (žlutá-bílá, zelená-bílá, ...).
Při dokončování modelu se řiďte konkrétní předlohou.

Reference:

archiv Českého rozhlasu
archiv České televize
soukromý archiv